

Evaluation Board and Circuit

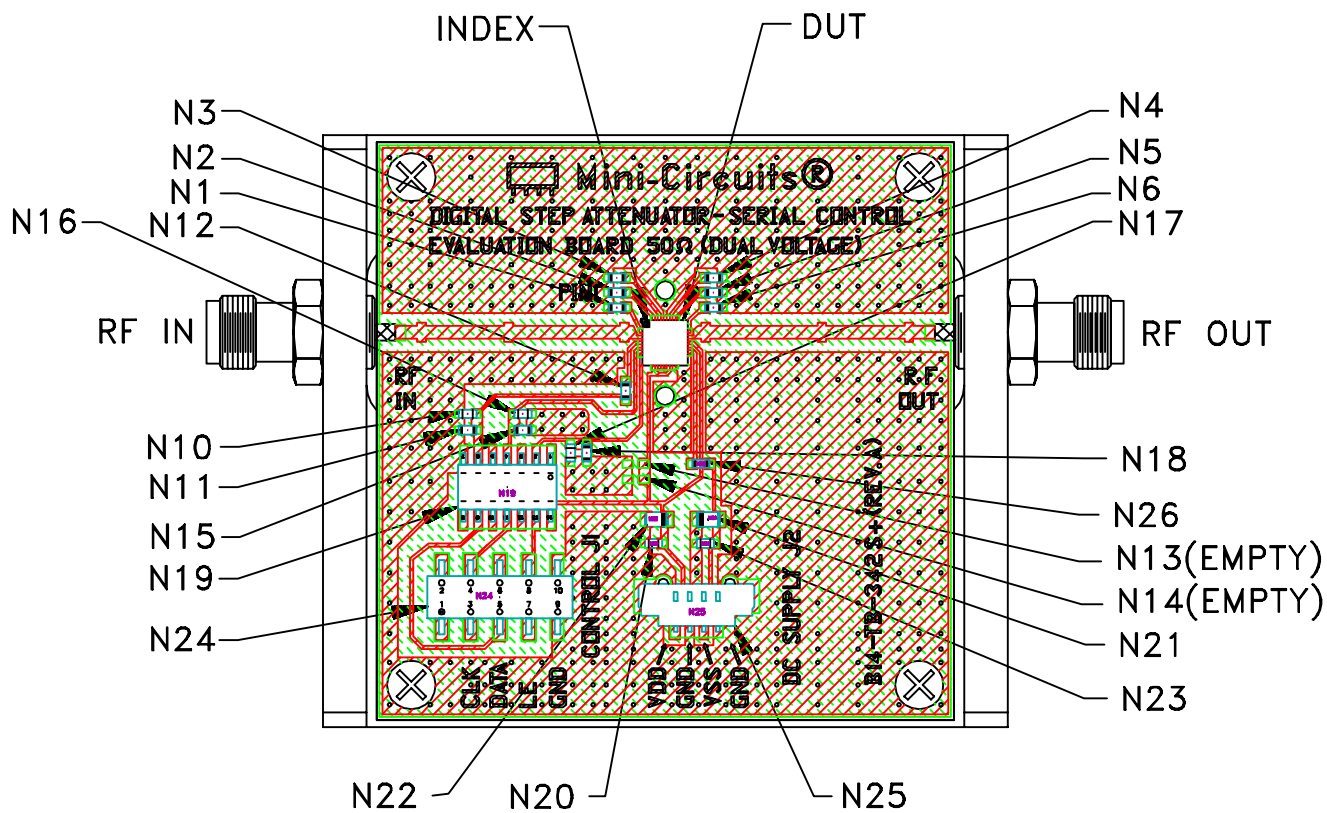

TB-342

Notes:

1. N-Type Female connectors.
2. PCB Material: FR4 Grade IT 180TC (ITEQ Corporation) or equivalent, Dielectric Constant=4.7, Thickness=.025 inch.

 Mini-Circuits®

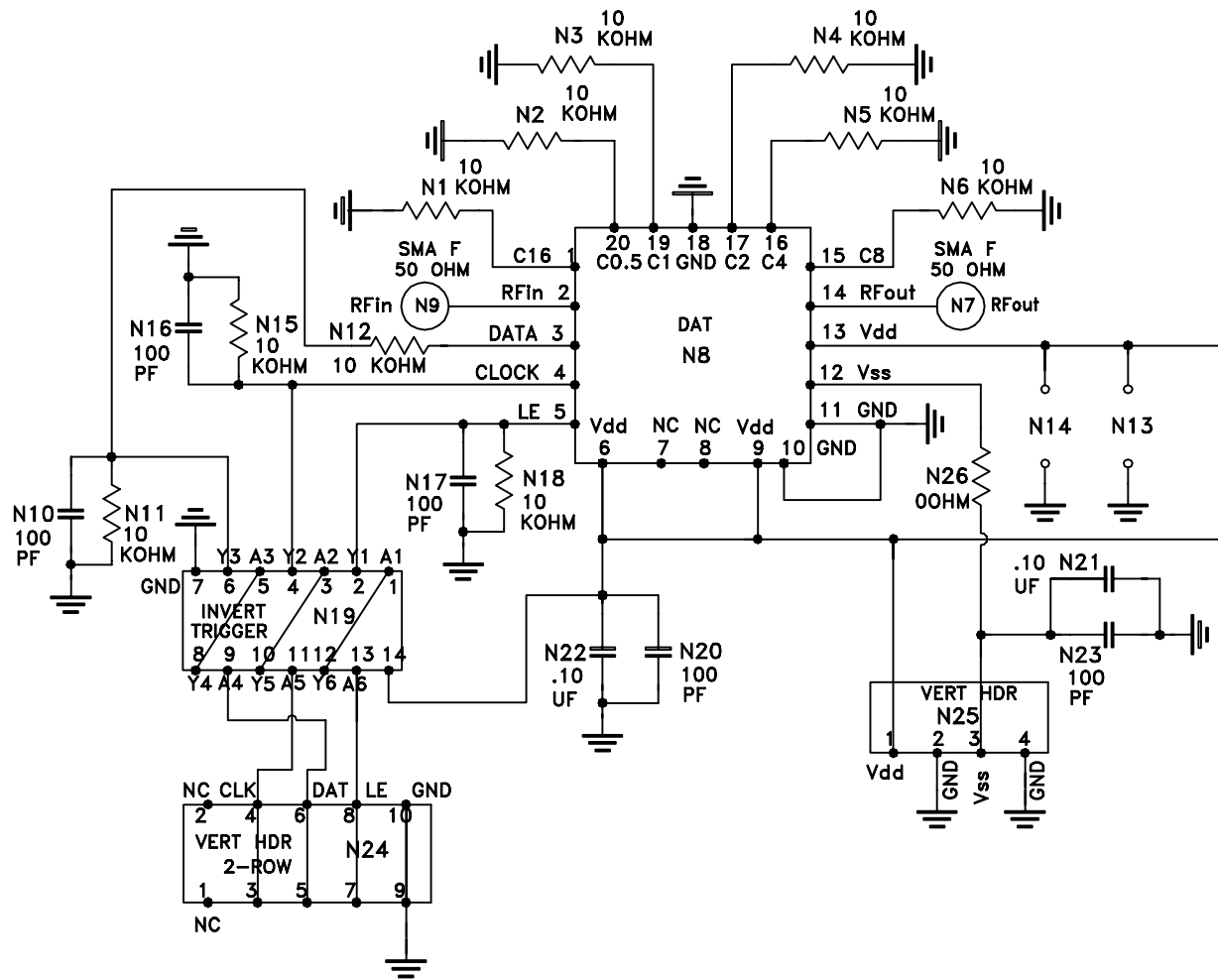

Schematic Diagram