



MMIC SURFACE MOUNT

Variable Gain Amplifier

PVGA-273+

50Ω 0.3 to 26.5 GHz High Dynamic Range

THE BIG DEAL

- Wide Bandwidth, 0.3 to 26.5 GHz
- Output P1dB, Typ. +15 dBm
- High OIP3, Typ. +29 dBm
- Adjustable Gain Range, Typ. 30 dB
- Supply Voltage, +5 V or +8 V
- 5x5 mm 32-Lead QFN-Style Package

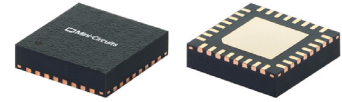

Generic photo used for illustration purposes only

FUNCTIONAL DIAGRAM

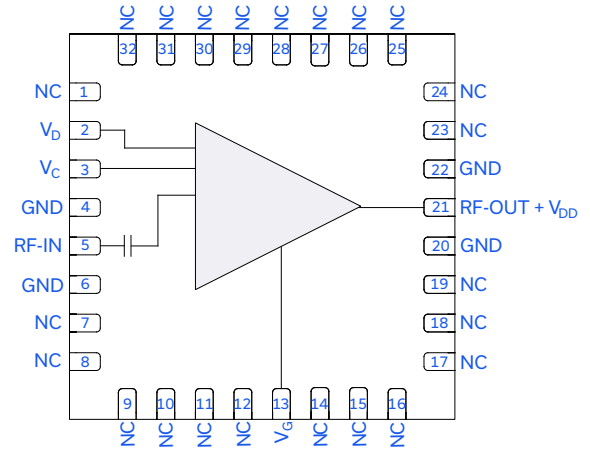

APPLICATIONS

- Test and Measurement Equipment
- Radar, EW, and ECM Defense Systems
- 5G MIMO and Back Haul Radio Systems
- Signal Distribution Networks

PRODUCT OVERVIEW

Mini-Circuits' PVGA-273+ is a low noise variable gain MMIC amplifier fabricated in GaAs pHEMT technology. Operating from 0.3 to 26.5 GHz, this amplifier features a high dynamic range with a 2.6 dB noise figure, 13.9 dB gain, +15 dBm P1dB, and +29 dBm OIP3. This design has the flexibility to operate from a +8 V drain voltage applied directly to the device or a +5 V drain voltage applied via a bias tee through the output port. An additional, optional supply voltage may be applied to enable a gain control range of 30 dB. The PVGA-273+ comes in an industry-standard 5x5 mm QFN-style package, with RF ports internally matched to 50Ω, facilitating easy integration into microwave systems.

KEY FEATURES

Features	Advantages
Wide Bandwidth, 0.3 to 26.5 GHz	Suitable for wide bandwidth defense and test and measurement applications, as well as narrowband performance-driven applications.
High P1dB & OIP3 <ul style="list-style-type: none"> • +15 dBm Typ. P1dB • +29 dBm Typ. OIP3 	Suitable as a driver amplifier in receiver/transmitter chains due to high linearity with low dissipated power.
Adjustable Gain Range <ul style="list-style-type: none"> • 30 dB 	Enables temperature compensation and power control for transmit and receive signal chains.
5x5 mm 32-Lead QFN-Style package	Small footprint saves space in dense layouts while providing low inductance, repeatable transitions, and excellent thermal contact to the PCB. Industry standard packaging allow for ease of assembly in high volume manufacturing processes.



MMIC SURFACE MOUNT

Variable Gain Amplifier

PVGA-273+

50Ω 0.3 to 26.5 GHz High Dynamic Range

ELECTRICAL SPECIFICATIONS¹ AT +25°C, V_c = OPEN, UNLESS NOTED OTHERWISE

Parameter	Frequency (GHz)	V _{DD} = +5 V (Applied at RF-OUT)			V _D = +8 V (Applied at Pin 2)			Units
		Min.	Typ.	Max.	Min.	Typ.	Max.	
Frequency Range		0.3		26.5	0.3		26.5	GHz
Gain	0.3		16.8			16.7		dB
	1.0		16.7			16.7		
	6.0		14.6			14.8		
	12.0		13.9			14.1		
	18.0		14.0			14.3		
	26.5		13.1			13.3		
Output Power at 1 dB Compression (P _{1dB})	0.3		+15.6			+14.9		dBm
	1.0		+15.9			+15.4		
	6.0		+16.1			+15.7		
	12.0		+15.0			+14.2		
	18.0		+14.2			+13.7		
	26.5		+12.7			+12.1		
Output Power at Saturation (P _{SAT}) ²	0.3		+18.9			+17.9		dBm
	1.0		+19.5			+18.2		
	6.0		+19.4			+18.4		
	12.0		+18.4			+17.3		
	18.0		+17.7			+16.7		
	26.5		+19.1			+16.8		
Output Third-Order Intercept (P _{OUT} = 0 dBm/Tone)	0.3		+28.4			+26.5		dBm
	1.0		+28.9			+27.2		
	6.0		+28.8			+27.7		
	12.0		+28.8			+26.6		
	18.0		+27.7			+26.2		
	26.5		+23.5			+23.1		
Input Return Loss	0.3		6			7		dB
	1.0		11			11		
	6.0		13			13		
	12.0		10			10		
	18.0		19			20		
	26.5		19			17		
Output Return Loss	0.3		12			11		dB
	1.0		20			20		
	6.0		12			12		
	12.0		11			11		
	18.0		17			17		
	26.5		15			14		
Isolation	0.3 – 26.5		40			39		dB
Noise Figure	0.3		3.0			3.9		dB
	1.0		2.1			2.5		
	6.0		1.9			2.0		
	12.0		2.6			2.3		
	18.0		2.8			2.8		
	26.5		4.2			4.2		
Device Operating Voltage (V _{DD} or V _D)			+5			+8		V
Device Operating Current (I _{DD} or I _D) ³			80			80		mA
Gate Voltage (V _G)		-0.46	-0.38	-0.31	-0.45	-0.37	-0.29	V
Gate Current (I _G)			0.02			0.02		mA
Control Voltage (V _C)		-1	Open	+2	-1	Open	+2	V

1. Tested on Mini-Circuits Characterization Test Board TB-PVGA-273C+. See Figure 2. De-embedded to the device reference plane.

2. P_{SAT} is defined as when the Output Power changes 0.1 dB per 1 dB change in Input Power.

3. Current at P_{IN} = -25 dBm. Increases to 89 mA typical at P1dB (V_{DD} = +5 V) and 86 mA typical at P1dB (V_D = +8 V).





MMIC SURFACE MOUNT

Variable Gain Amplifier

PVGA-273+

50Ω 0.3 to 26.5 GHz High Dynamic Range

ELECTRICAL SPECIFICATIONS⁴ OVER VARIOUS V_c AT +25°C, $V_{DD} = +5 V$ (APPLIED AT RF-OUT), UNLESS NOTED OTHERWISE

Parameter	Frequency (GHz)	Control Voltage, V_c			Units
		-0.7 V Typ.	+1 V Typ.	+2 V Typ.	
DC Current		23	51	82	mA
Gain	0.3	11.2	16.0	16.8	dB
	1.0	10.8	15.9	16.7	
	6.0	6.6	13.5	14.5	
	12.0	5.4	12.8	13.8	
	18.0	5.0	12.9	14.0	
	26.5	2.5	11.9	13.1	
Output Power at 1 dB Compression (P_{1dB})	0.3	-2.2	+14.4	+15.5	dBm
	1.0	-2.7	+14.4	+15.8	
	6.0	-4.2	+14.3	+16.0	
	12.0	-3.9	+13.5	+14.9	
	18.0	-3.7	+12.5	+14.1	
	26.5	-3.7	+11.0	+12.6	
Output Power at Saturation (P_{SAT}) ⁵	0.3	+0.8	+17.3	+18.9	dBm
	1.0	+0.2	+17.7	+19.4	
	6.0	-0.3	+17.6	+19.4	
	12.0	+2.1	+16.9	+18.4	
	18.0	+5.5	+16.1	+17.7	
	26.5	+1.3	+17.7	+19.1	
Output Third-Order Intercept ($P_{OUT} = -9$ dBm/Tone)	0.3	+5.9	+24.9	+25.9	dBm
	1.0	+5.7	+24.7	+26.4	
	6.0	+4.9	+25.2	+27.4	
	12.0	+5.0	+24.2	+26.2	
	18.0	+4.9	+23.1	+25.4	
	26.5	+5.0	+20.2	+22.0	
Input Return Loss	0.3	4	6	6	dB
	1.0	6	11	11	
	6.0	8	12	13	
	12.0	7	9	10	
	18.0	17	21	19	
	26.5	18	18	19	
Output Return Loss	0.3	13	12	12	dB
	1.0	24	26	25	
	6.0	12	12	12	
	12.0	11	11	11	
	18.0	18	18	18	
	26.5	15	15	15	
Isolation	0.3 – 26.5	33	38	39	dB
Noise Figure	0.3	5.8	4.1	3.9	dB
	1.0	3.3	2.5	2.4	
	6.0	4.1	2.3	2.2	
	12.0	4.4	2.3	2.2	
	18.0	5.2	2.8	2.7	
	26.5	7.1	4.1	4.1	

4. Tested on Mini-Circuits Characterization Test Board TB-PVGA-273C+. See Figure 2. De-embedded to the device reference plane.

5. P_{SAT} is defined as when the Output Power changes 0.1 dB per 1 dB change in Input Power.



**MMIC SURFACE MOUNT**

Variable Gain Amplifier

PVGA-273+

Mini-Circuits

50Ω 0.3 to 26.5 GHz High Dynamic Range

ELECTRICAL SPECIFICATIONS⁶ OVER VARIOUS V_c AT +25°C, $V_D = +8$ V (Applied at Pin 2), UNLESS NOTED OTHERWISE

Parameter	Frequency (GHz)	Control Voltage, V_c			Units
		-0.7 V Typ.	+1 V Typ.	+2 V Typ.	
DC Current		37	58	82	mA
Gain	0.3	15.2	16.2	16.7	dB
	1.0	14.7	16.1	16.7	
	6.0	11.9	14.0	14.8	
	12.0	11.0	13.3	14.1	
	18.0	9.5	13.4	14.2	
	26.5	7.4	12.3	13.2	
Output Power at 1 dB Compression (P_{1dB})	0.3	+5.9	+14.2	+14.8	dBm
	1.0	+4.8	+14.0	+15.3	
	6.0	+4.0	+14.2	+15.7	
	12.0	+3.4	+13.4	+14.1	
	18.0	+2.6	+12.3	+13.5	
	26.5	+1.0	+11.2	+11.8	
Output Power at Saturation (P_{SAT}) ⁷	0.3	+8.9	+17.5	+17.9	dBm
	1.0	+8.4	+17.8	+18.3	
	6.0	+8.4	+17.9	+18.4	
	12.0	+8.0	+16.9	+17.3	
	18.0	+8.6	+16.4	+16.7	
	26.5	+7.1	+16.8	+16.5	
Output Third-Order Intercept ($P_{OUT} = -9$ dBm/Tone)	0.3	+17.2	+26.0	+26.8	dBm
	1.0	+16.7	+25.5	+27.3	
	6.0	+15.4	+25.5	+28.0	
	12.0	+14.1	+24.5	+26.7	
	18.0	+13.5	+24.4	+27.1	
	26.5	+11.4	+21.3	+23.2	
Input Return Loss	0.3	6	6	7	dB
	1.0	9	11	11	
	6.0	11	12	13	
	12.0	9	9	10	
	18.0	20	21	20	
	26.5	17	17	17	
Output Return Loss	0.3	14	12	11	dB
	1.0	19	26	24	
	6.0	11	12	12	
	12.0	11	11	11	
	18.0	18	18	17	
	26.5	15	14	14	
Isolation	0.3 – 26.5	35	38	39	dB
Noise Figure	0.3	7.5	4.7	3.9	dB
	1.0	4.1	2.8	2.5	
	6.0	2.8	2.1	2.1	
	12.0	3.3	2.3	2.3	
	18.0	3.9	2.8	2.8	
	26.5	5.7	4.2	4.3	

6. Tested on Mini-Circuits Characterization Test Board TB-PVGA-273C+. See Figure 2. De-embedded to the device reference plane.

7. P_{SAT} is defined as when the Output Power changes 0.1 dB per 1 dB change in Input Power.



TYPICAL PERFORMANCE GRAPHS WITH $V_{DD} = +5\text{ V}$ AND $V_D = \text{OPEN}$

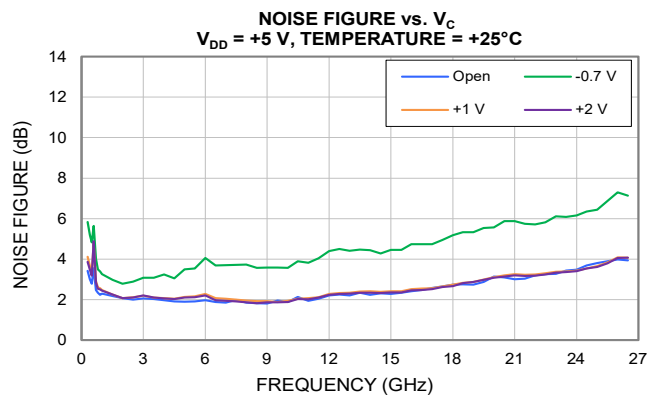
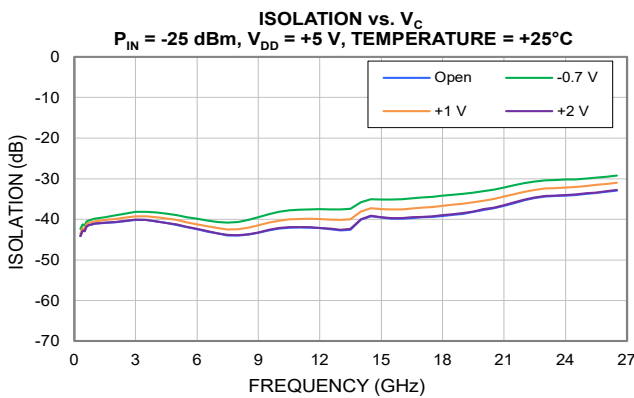
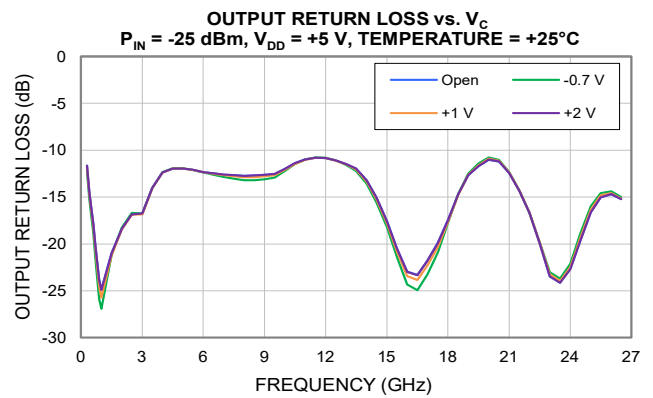
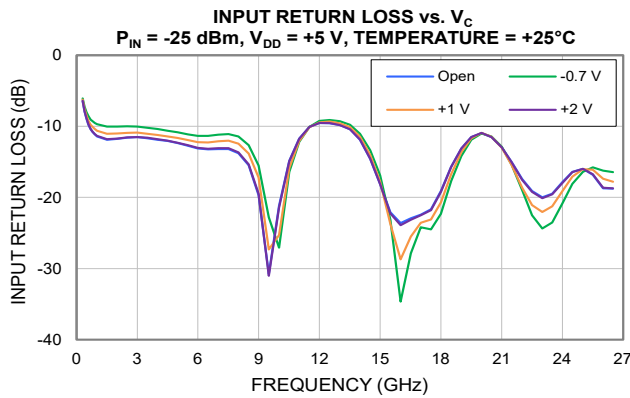
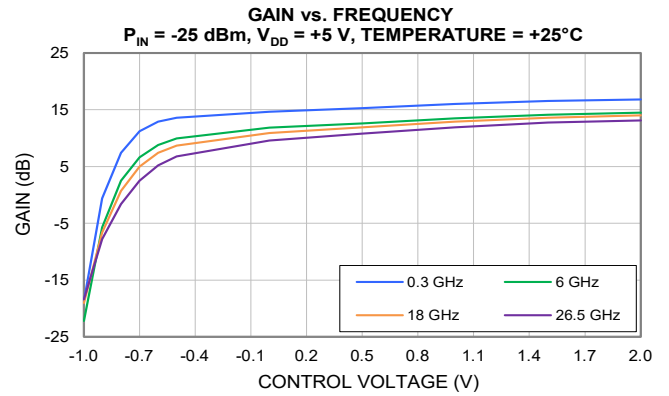
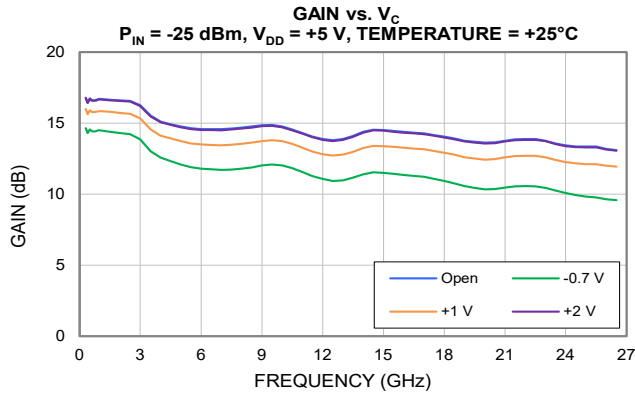



TYPICAL PERFORMANCE GRAPHS WITH $V_{DD} = +5\text{ V}$ AND $V_D = \text{OPEN}$

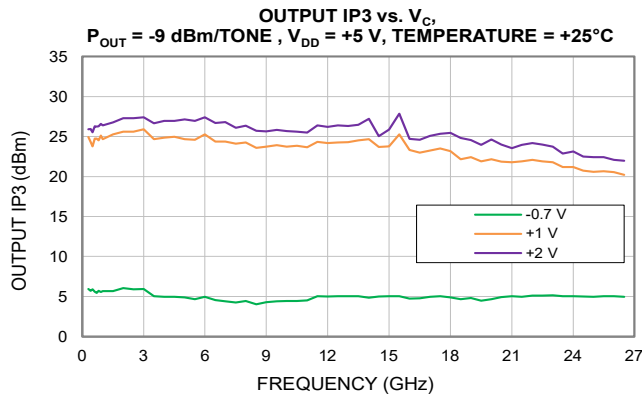
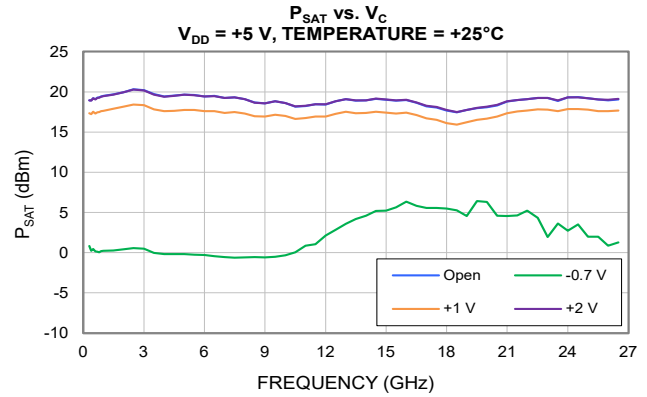
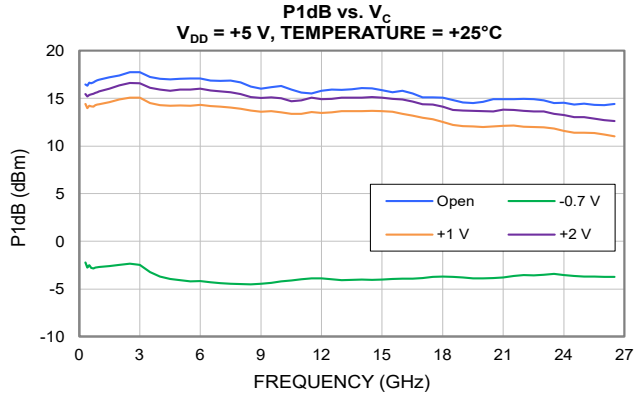



TYPICAL PERFORMANCE GRAPHS WITH $V_{DD} = +5\text{ V}$ AND $V_D = \text{OPEN}$.
 V_G ADJUSTED AT EACH TEMPERATURE TO SET $I_{DD} = 80\text{ mA}$

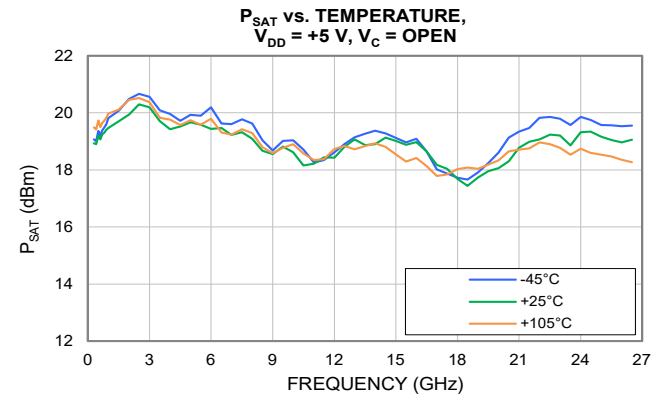
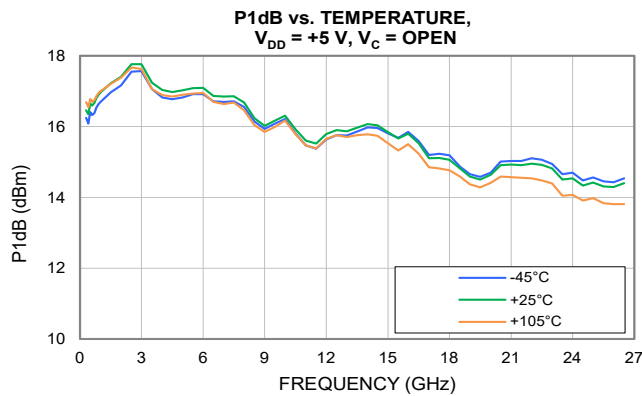
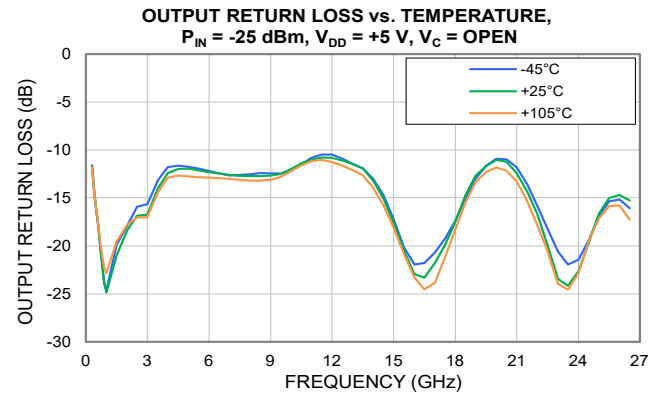
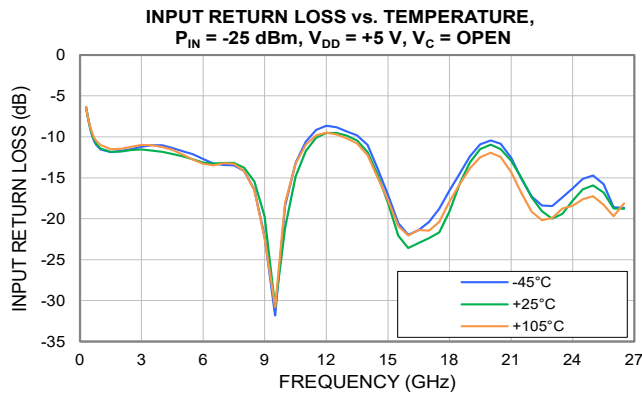
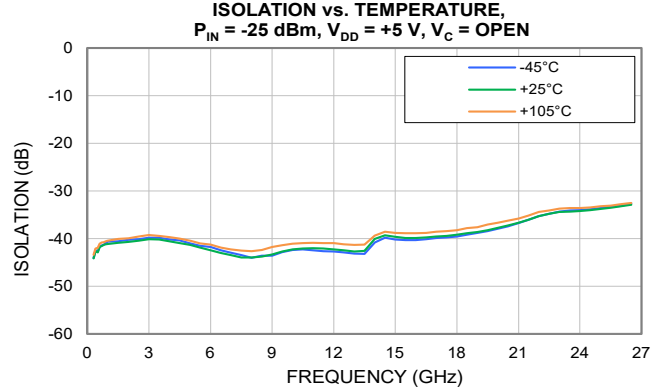
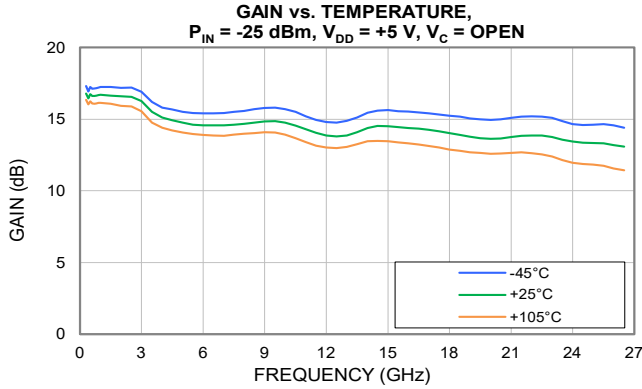



TYPICAL PERFORMANCE GRAPHS WITH $V_{DD} = +5\text{ V}$ AND $V_C = \text{OPEN}$.
 V_G ADJUSTED AT EACH TEMPERATURE TO SET $I_{DD} = 80\text{ mA}$.

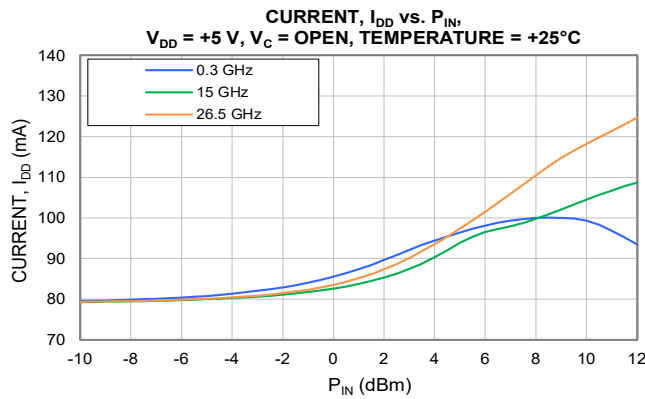
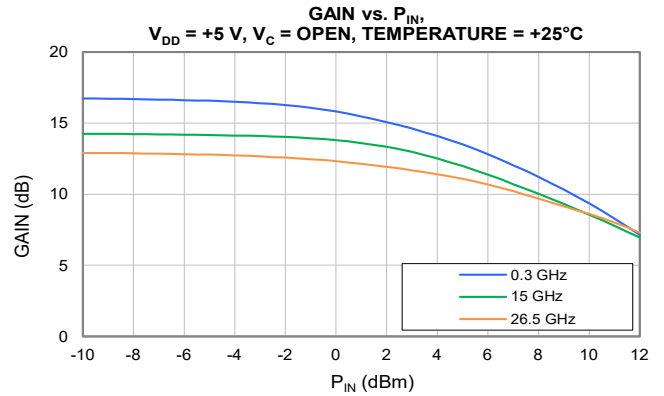
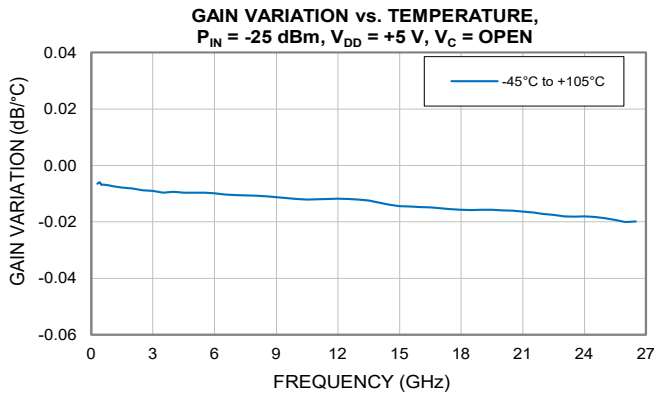
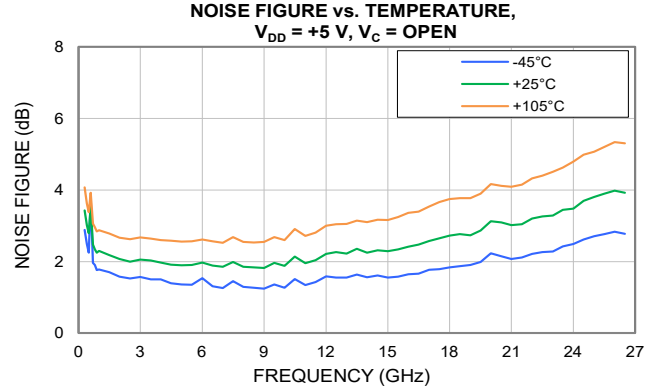
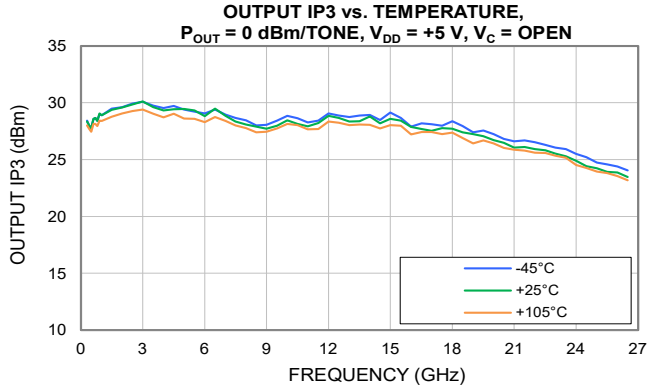



TYPICAL PERFORMANCE GRAPHS WITH $V_{DD} = \text{OPEN}$ AND $V_D = +8 \text{ V}$

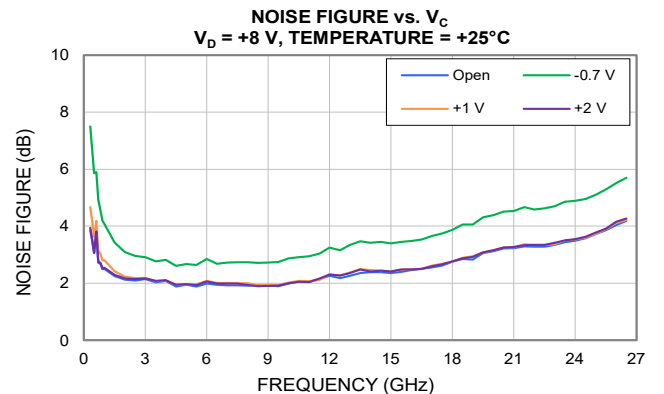
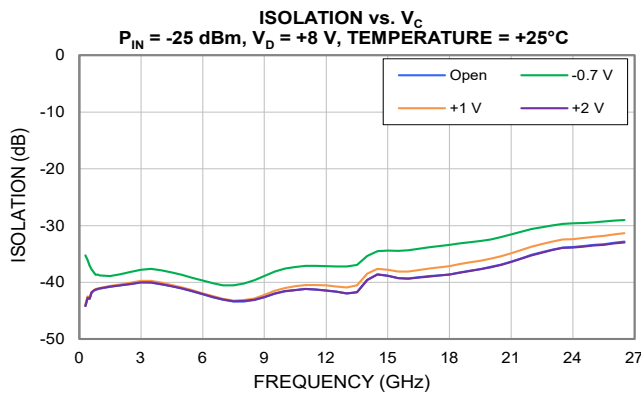
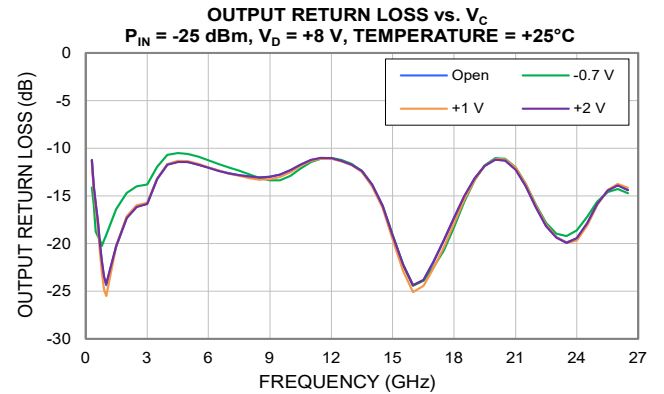
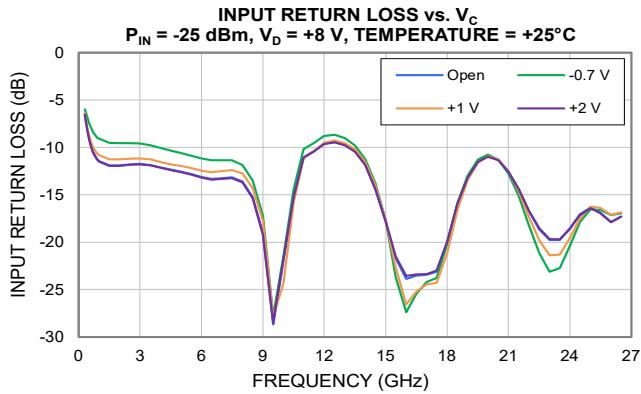
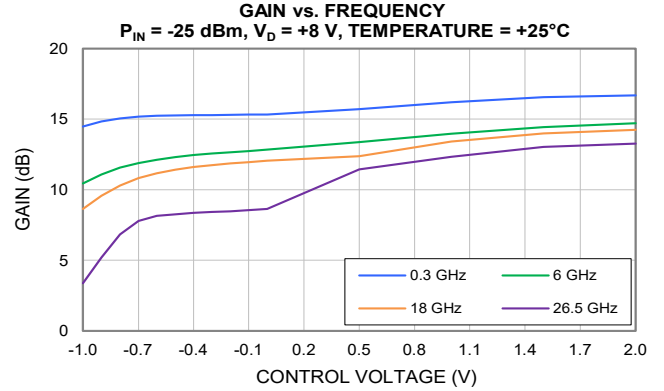
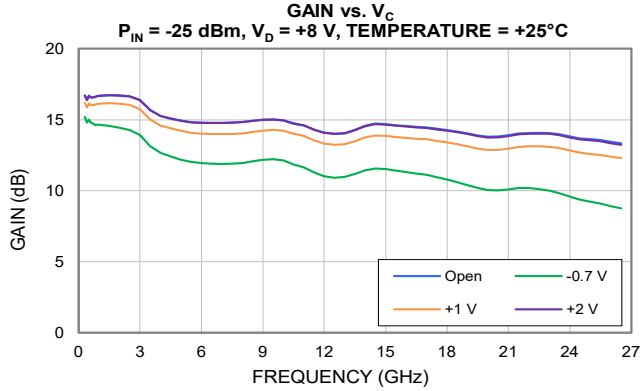



MMIC SURFACE MOUNT

Variable Gain Amplifier

PVGA-273+

Mini-Circuits

50Ω 0.3 to 26.5 GHz High Dynamic Range

TYPICAL PERFORMANCE GRAPHS WITH $V_{DD} = \text{OPEN}$ AND $V_D = +8\text{ V}$

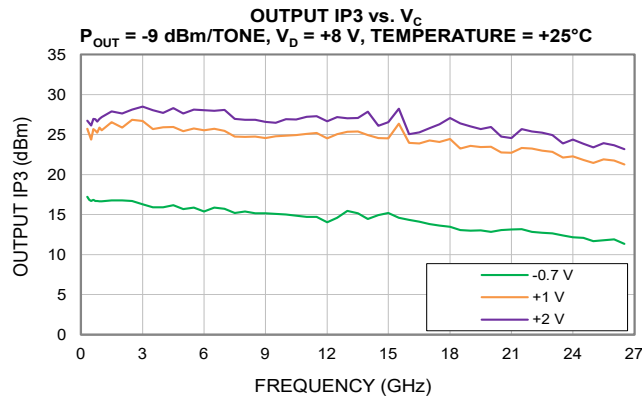
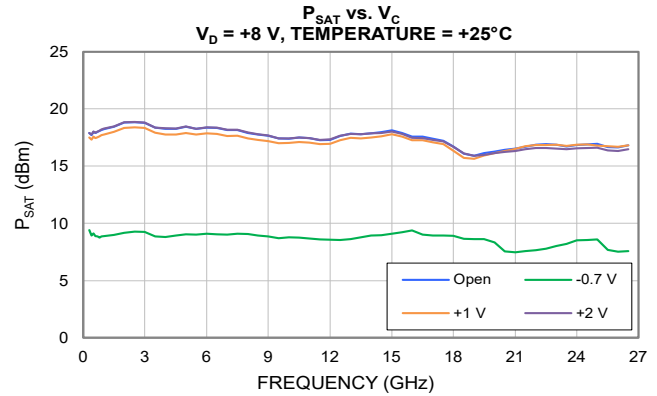
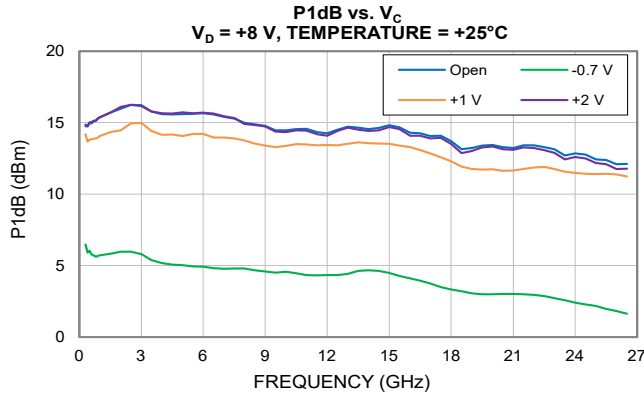



MMIC SURFACE MOUNT

Variable Gain Amplifier

PVGA-273+

50Ω 0.3 to 26.5 GHz High Dynamic Range

ABSOLUTE MAXIMUM RATINGS⁸

Parameter	Ratings
Operating Temperature	-45°C to +105°C
Storage Temperature	-65°C to +150°C
Junction Temperature ⁹	+150°C
Total Power Dissipation, $V_{DD} = +5\text{ V}$	2.75 W
Total Power Dissipation, $V_D = +8\text{ V}$	2.75 W
Input Power (CW), $V_{DD} = +5\text{ V}$	+24 dBm
Input Power (CW), $V_D = +8\text{ V}$	+24 dBm
DC Voltage on V_{DD}	+11 V
DC Voltage on V_D	+11 V
Current I_{DD}	250 mA
Current I_D	250 mA
DC Voltage on V_G	0 V
Current I_G	0.18 mA
DC Voltage on V_C	+2 V

8. Permanent damage may occur if any of these limits are exceeded. Maximum ratings are not intended for continuous normal operation.

9. Peak temperature on top of Die.

THERMAL RESISTANCE

Parameter	Ratings
Thermal Resistance (Θ_{JC}) ¹⁰	7.2°C/W

10. $\Theta_{JC} = (\text{Hot Spot Temperature on Die} - \text{Temperature at Ground Lead}) / \text{Dissipated Power}$

ESD RATING

	Class	Voltage Range	Reference Standard
HBM	1A	250 to < 500 V	ANSI/ESDA/JEDEC JS-001-2017
CDM	C3	≥ 1000 V	JESD22-C101F



ESD HANDLING PRECAUTION: This device is designed to be Class 1A for HBM. Static charges may easily produce potentials higher than this with improper handling and can discharge into DUT and damage it. As a preventive measure industry standard ESD handling precautions should be used at all times to protect the device from ESD damage.

MSL RATING

Moisture Sensitivity: MSL3 in accordance with IPC/JEDEC J-STD-020E/JEDEC J-STD-033C





FUNCTIONAL DIAGRAM

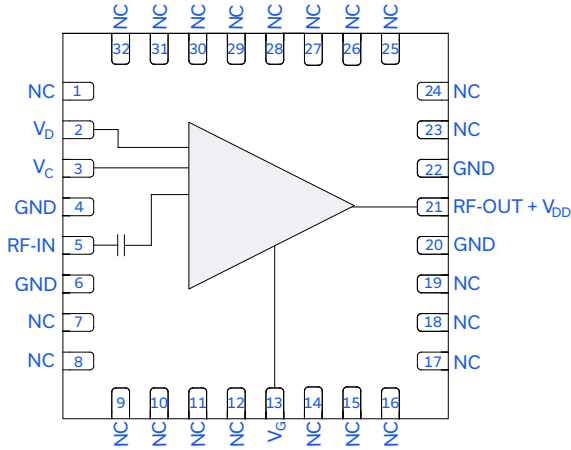

Figure 1. PVGA-273+ Functional Diagram

PAD DESCRIPTION¹¹

Function	Pad Number	Application Description (Refer to Figure 2)
RF-IN	5	RF-IN Pad connects to RF input port.
RF-OUT + V _{DD}	21	RF-OUT Pad connects to RF output and V _{DD} port.
V _G	13	DC Input Pad connects to gate voltage input port.
V _D	2	DC Input Pad connects to drain voltage input port.
V _C	3	DC Input Pad connects to control voltage input port.
GND	4, 6, 20, 22, & Paddle	Connects to ground.
NC	1, 7-12, 14-19, & 23-32	Not used internally. Connects to ground on characterization test board.

11. V_D and V_{DD} are separate independent voltage pins. PVGA-273+ can be operated by either applying +5V (typ.) to Pad 21 V_{DD} or +8V (typ.) to Pad 2 V_D. Do not apply voltage to both Pad 2 and Pad 21 simultaneously. Applying voltage to both Pad 2 and Pad 21 simultaneously will damage the device.

CHARACTERIZATION BOARD^{12, 13, 14}

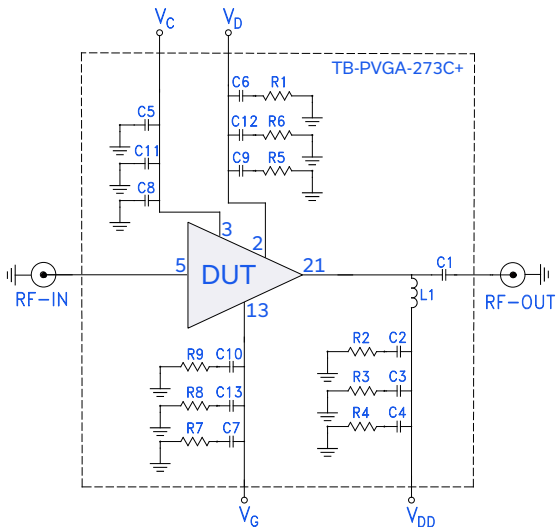

- 12. Characterization data when V_D = +8 V taken with L1 removed and left Open.
- 13. Components L1, C2, C3, C4, R2, R3, and R4 are not required when biasing through V_D.
- 14. Components C6, C9, C12, R1, R5, and R6 are not required when biasing through V_{DD}.

Figure 2. PVGA-273+ Characterization and Application Circuit.

Electrical Parameters and Conditions

Gain, Return Loss, Output Power at 1dB Compression (P1dB), Output IP3 (OIP3), and Noise Figure measured using N5247B PNA-X microwave network analyzer.

Conditions:

1. Gain and Return Loss: P_{IN} = -25 dBm
2. Output IP3 (OIP3): Two tones, spaced 1 MHz apart:
 - a. 0 dBm/Tone at output when V_C = open.
 - b. -9 dBm/Tone at output when V_C is varied.

Caution: Permanent damage to the device will occur if the Power ON and Power OFF sequences are not followed.

Power ON:

- 1) Set V_G = -2 V. Apply V_G.
- 2) Set V_{DD} = +5 V or V_D = +8 V. Apply V_{DD} or V_D.
- 3) Increase V_G to obtain the desired I_{DD} as shown in the Electrical Specification Table.
- 4) Apply V_C if required, for variable gain control. Not required for typical operation.
- 5) Apply RF signal.

Power OFF:

- 1) Turn Off RF signal.
- 2) Turn Off V_C if applied.
- 3) Adjust V_G down to -2 V.
- 4) Turn Off V_{DD} or V_D.
- 5) Turn Off V_G.

Component	Value	Size	Part Number	Manufacturer
L1	0.6 uH	1105	CC36T44K240G5-C	PICONICS
C1	30 pF	0201	P21BN300M5ST	Knowles Dielectric
C2, C8, C9, C10	100 pF	0402	GRM1555C1H101JA01D	Murata
C3	0.01 uF	0402	04023C103KAT2A	AVX Corporation
C4 - C7	4.7 uF	1206	12063C475KAT2A	AVX Corporation
C11 - C13	0.001 uF	0402	GRM1555C1H102JA01D	Murata
R1 - R9	0Ω Jumper	0402	RK73Z1ETTP	KOA Speer



CASE STYLE DRAWING

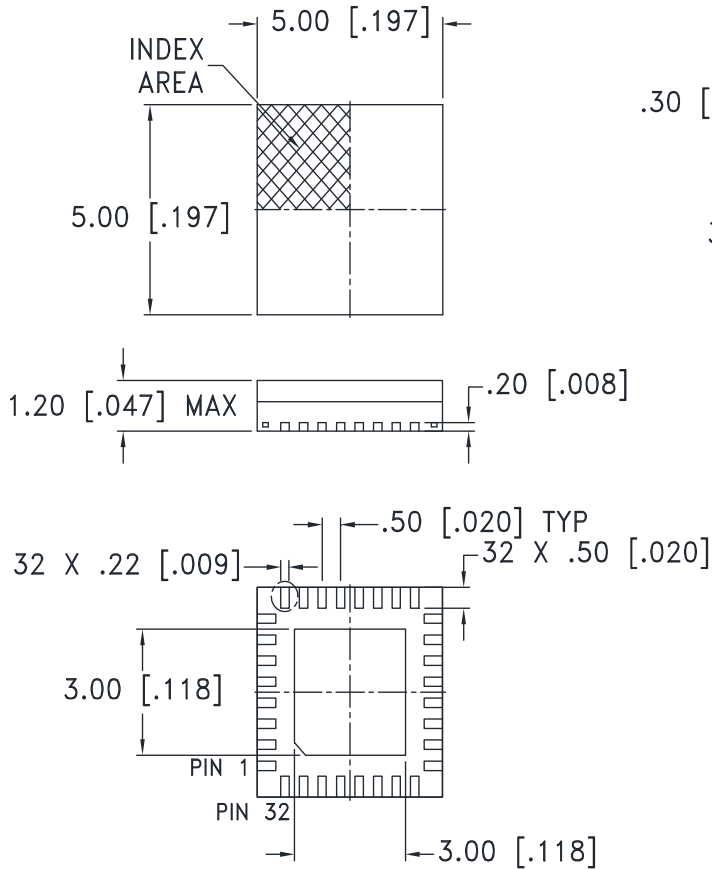

PCB Land Pattern

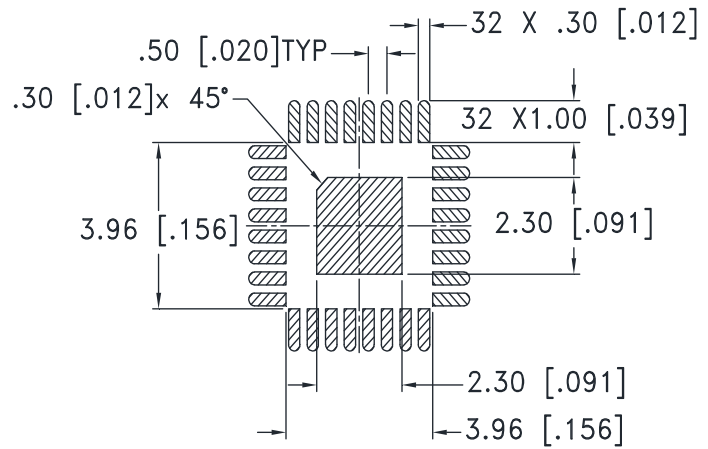

SUGGESTED LAYOUT
TOLERANCE TO BE WITHIN ±.002

NOTES:

- 1.  DENOTES METALLIZATION

Weight: 0.1 Grams

Dimensions are in mm [inches]. Tolerances: 2 Pl. ± .25[.01]; 3 Pl. ± .127 [.005]

PRODUCT MARKING



Marking may contain other features or characters for internal lot control



MMIC SURFACE MOUNT

Variable Gain Amplifier

PVGA-273+

50Ω 0.3 to 26.5 GHz High Dynamic Range

ADDITIONAL DETAILED INFORMATION IS AVAILABLE ON OUR DASHBOARD. [CLICK HERE](#)

Performance Data and Graphs	Data
	Graphs
	S-Parameter (S2P Files) Data Set (.zip file)
Case Style	DG1677-4 Plastic package, exposed paddle, Lead Finish: PPF
RoHS Status	Compliant
Tape & Reel	F73
Standard quantities available on reel	7" reels with 20, 50, 100, 200, or 500 devices
Suggested Layout for PCB Design	PL-769
Evaluation Board	TB-PVGA-273C+
	Gerber File
Environmental Ratings	ENV08T10
Product Handling	The use of no-clean solder is recommended. This package cannot be subjected to aqueous wash.

NOTES

- A. Performance and quality attributes and conditions not expressly stated in this specification document are intended to be excluded and do not form a part of this specification document.
- B. Electrical specifications and performance data contained in this specification document are based on Mini-Circuit's applicable established test performance criteria and measurement instructions.
- C. The parts covered by this specification document are subject to Mini-Circuits standard limited warranty and terms and conditions (collectively, "Standard Terms"); Purchasers of this part are entitled to the rights and benefits contained therein. For a full statement of the standard terms and the exclusive rights and remedies thereunder, please visit Mini-Circuits' website at www.minicircuits.com/terms/viewterm.html

