

Test Solutions

2021-22

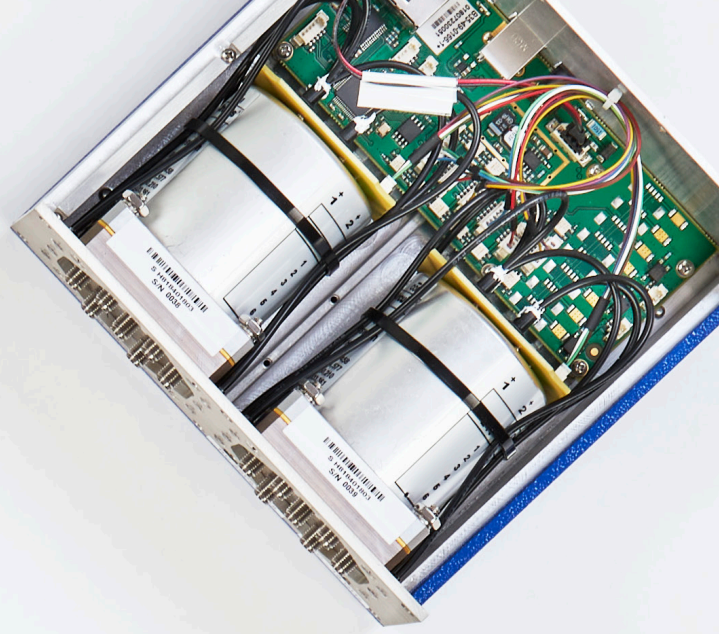

Get More Out of Your Test Setup

Equipment for test and measurement is one of the largest investments for most companies developing RF/microwave products. The capability to test many devices quickly and reliably can greatly reduce overall production cost and time to market, and a powerful test setup can be a significant competitive advantage. As new applications require more advanced measurements and migrate to higher frequency bands, high-end test instrumentation can run well into the six-figure range, which presents a high barrier to increasing test throughput.

But developing a fast, efficient test setup or expanding capacity of your existing setup needn't require prohibitive cost. Mini-Circuits has developed a line of innovative products to help customers get more out of their test setups by

integrating functions of switching and routing, attenuation, signal generation, sensing and more. Depending on the application, these functions may be used as standalone solutions off the shelf or easily integrated to build scalable, automated testing platforms customized to each user's individual needs. Our test solutions are easy to control via USB, Ethernet and a variety of other convenient interfaces, and our complete software package gives you the ability to plug and play right out of the box, or develop your own software.

Mini-Circuits has successfully helped hundreds of customers improve efficiency and reduce cost in their test operation, and we hope the information in this guide gives you some ideas about how we can help you do the same.



The Mini-Circuits Difference

Flexible

Every test application is unique. At Mini-Circuits, our wealth of components in stock allows us to take a building-block approach to developing systems that meet the specific needs of each test setup. From off-the-shelf components and modules to turnkey custom builds, our solutions give you all the functions you need with the flexibility to scale and modify your stack as your needs evolve over time.

- Wide variety of components in stock from DC to 67 GHz
- Off-the-shelf, DIY kits, modular and custom options
- Flexible hardware, software and firmware
- Expand and reconfigure as your needs change

Reliable

When you work with Mini-Circuits to expand your test setup, you're getting the assurance that comes with 50+ years of quality management experience. All our test solutions come fully tested and characterized by our team in house, and meet the rigorous standards that have earned the industry's trust since 1968.

- All components and assembled systems tested and characterized in-house
- Rugged designs for demanding lab and production environments
- Award-winning quality excellence

Affordable

Most high-end test equipment comes at a heavy premium for dozens of advanced features that many users don't need. Mini-Circuits test solutions give you the high-performance and functionality you need to get more out of your test setup without the heavy capital expenditures.

- Get more functionality and capacity out of your existing instrumentation
- High-performance custom systems without breaking the bank
- Save cost on extra features you don't need

Fast

We know the turnaround time on custom test equipment directly affects your time to market. That's why we put the full capability of our manufacturing and supply chain organizations behind our test solutions to make speed a competitive advantage. Mini-Circuits offers some of the fastest turnaround times on custom test equipment in the industry.

- Wide selection of models in stock for immediate shipment
- Modular systems for quick, user-defined configuration
- Established process for custom designs refined over hundreds of successful projects

PRODUCT LINE OVERVIEW 07-08

CUSTOM SYSTEMS 61

INTEGRATED AMPLIFIERS 43-45

LAB ACCESSORIES 62-68

MEASUREMENT 47-54

eVNA 2-Port Vector Network Analyzer 47-50

Power Sensors 51-53

Signal Generators 54

PANEL MOUNTED STRUCTURES 55-58

Patch Panels 56

Passive Component Panels 57-58

SIGNAL CONDITIONING & ATTENUATORS 29-34

Programmable Attenuators Off the Shelf 29-31

Multi-Channel Attenuators Off the Shelf 32

Rack-Mount Attenuation Systems 33-34

SIGNAL DISTRIBUTION 59-60

SWITCHING & ROUTING 09-29

Mechanical Switch Boxes 11-12

Modular Switch Systems 13-14

Mechanical Switch Arrays 15-16

Solid State Switches 17-18

Solid State Switch Racks 19-20

Switch Matrices 21-28

 Non-Blocking 22-23

 Blocking 24-26

 Full Fan-Out Matrices 27-28

TARGETED SOLUTIONS & USE CASES 35-42

Cellular Handover Test Systems 35-36

Mesh Network Simulation Racks 37-38

High Power Test Systems 39-42

Personal Engineer-to-Engineer Support

Customers choose Mini-Circuits because they know they're getting quality and performance they can count on. But what really sets us apart is our close collaboration with customers at the engineering level from definition to delivery.

The specifications for many systems are often defined concurrently with the design process, and customers look to us to partner with them in making their projects successful. That means we need the competence and expertise to understand your needs, and the agility in our processes design and assemble a diverse range of user-defined solutions on a tight timeline.

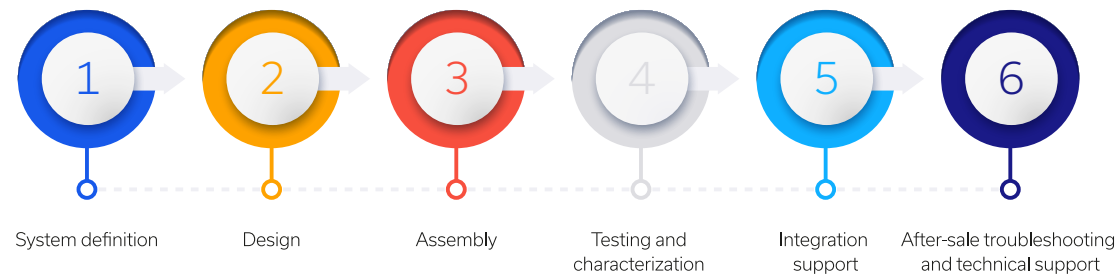

Our Software or Yours

Plug and Play

Mini-Circuits' User-Friendly GUI Software

All Mini-Circuits test solutions come ready to use out of the box with our user-friendly GUI software for Windows® systems. Just install the software package on your PC, connect to the unit via USB or LAN and get to work. Mini-Circuits' GUI program gives you manual control over the hardware with a simple point-and-click interface as well as the ability to automate sequences for your test flow.

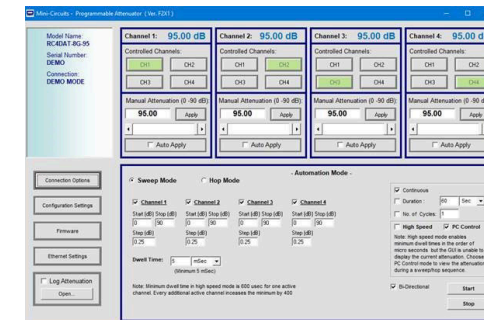

Software Highlights:

- LAN interface for remote control over a network
- USB interface for local PC control
- Automate switching, attenuation and measurement functions from any common programming environment
- LabVIEW, MatLab, Python, C#, C++, VB supported
- Simple "point and click" control using Mini-Circuits' user-friendly GUI

Integrate with Your Native Test Software

Full API and Programming Instructions

For users already working with Python, LabVIEW® or other popular test software, we provide a full API with programming instructions for Windows and Linux® environments with every system. This way you have the option to write your own program and integrate your Mini-Circuits hardware seamlessly with the rest of your test setup.

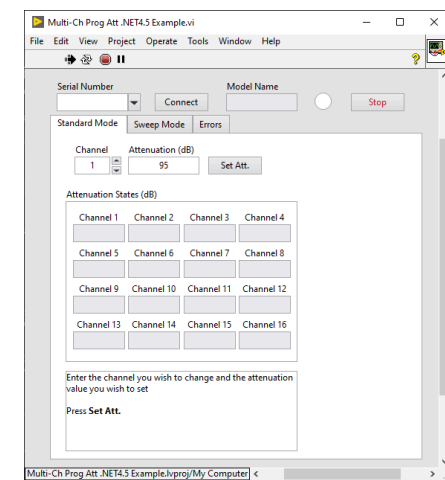

Switching & Routing

Managing signal traffic between measurement instrumentation and multiple devices under test (DUTs) is one of the most common needs in all lab environments. Mini-Circuits offers a full range of solutions for switching and routing, whether you're looking for complex, integrated switch matrices, simple benchtop switch modules, or discrete mechanical and solid-state switches to assemble yourself.

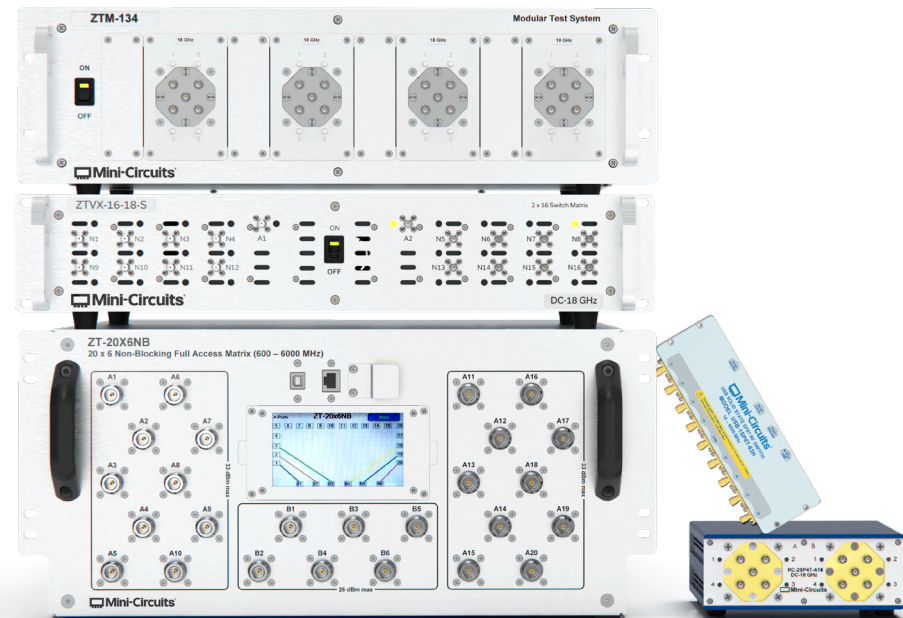
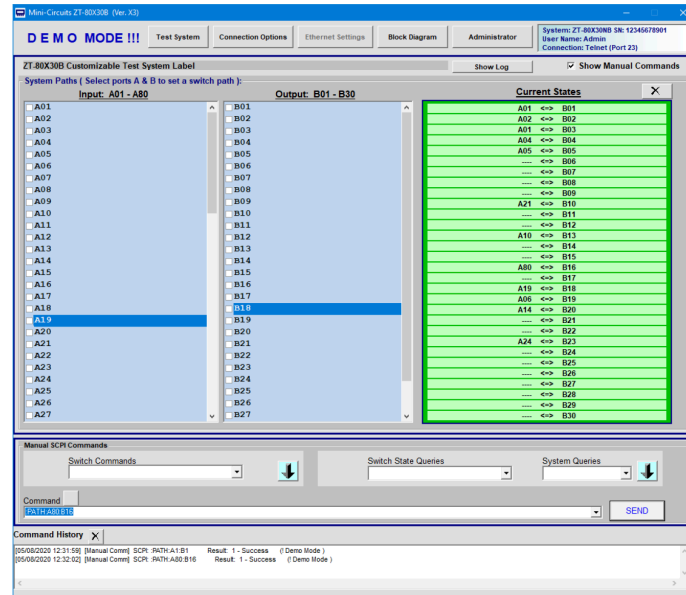

Options for Every Requirement:

- Mechanical switch boxes from stock
- Modular switch systems
- Rack mount mechanical switch arrays and switch matrices
- Solid state switch systems
- Custom switching systems

Mechanical Switch Boxes

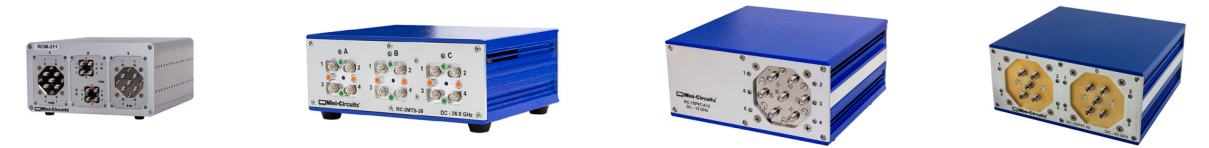

Overview

Mini-Circuits' compact RC- and RCM-series USB- and Ethernet-controlled switch boxes offer versatile high-performance mechanical switch systems for lab and production environments. A wide range of switch options are available from stock, from SPDT to SP8T, with frequency ranges up to 50 GHz. Each switch box is integrated with a robust controller supporting Ethernet & USB interfaces. Our electromechanical switches offer exceptionally wide bandwidths with low insertion loss, high isolation and high power ratings, ideal for test and automation applications.

Key Benefits

- Typically available from stock for immediate shipment
- Affordable solution for a wide range of signal routing and test requirements
- Small size for almost any lab environment

Catalog Models

Model Number	Switch Type	Frequency	Switch Count	Termination	Connectors
RC-1SPDT-A18	SPDT	DC - 18 GHz	1	Absorptive	SMA
RC-2SPDT-A18			2		
RC-4SPDT-A18			4		
RC-8SPDT-A18			8		
RC-1SPDT-A26	SPDT	DC - 26.5 GHz	1	Absorptive	SMA
RC-2SPDT-A26			2		
RC-4SPDT-A26			4		
RC-2SPDT-40			2		
RC-4SPDT-40	4	DC - 40 GHz	4	Reflective	2.92 mm
RC-2SPDT-50	SPDT	DC - 50 GHz	2	Reflective	2.4 mm
RC-4SPDT-50			4		

Catalog Models Continued

Model Number	Switch Type	Frequency	Switch Count	Termination	Connectors
RC-2MTS-18	DPDT	DC - 18 GHz	2	Transfer	SMA
RC-3MTS-18			3		
RC-2MTS-26			2		
RC-3MTS-26		3			
RC-2MTS-40		2			
RC-3MTS-40		3			
RC-1SP4T-A18	SP4T	DC - 18 GHz	1	Absorptive	SMA
RC-2SP4T-A18			2		
RC-1SP4T-26			1		
RC-2SP4T-26		2			
RC-1SP4T-40		1			
RC-2SP4T-40		2			
RC-1SP4T-50	1	DC - 50 GHz	1	Absorptive	2.4 mm
RC-1SP6T-A12	SP6T	DC - 12 GHz	1	Absorptive	SMA
RC-2SP6T-A12			2		
RC-2SP6T-A18			2		
RC-1SP6T-26		1			
RC-2SP6T-26		2			
RC-1SP6T-40		1			
RC-2SP6T-40	2	DC - 40 GHz	2	Absorptive	2.92 mm
RC-1SP6T-50	1	DC - 50 GHz	1	Absorptive	2.4 mm
RCM-1SP8T-12	SP8T	DC - 12 GHz	1	Absorptive	SMA
RCM-2SP8T-12			2		
RCM-1SP8T-26		1			
RCM-2SP8T-26		2			

Modular Switch Systems

Overview

Mini-Circuits' modular switch systems offer flexibility, customizable functionality and fast turnaround for automated test setups. Choose one of our standard benchtop or rack-mount chassis structures and configure your system with our industry-leading range of rugged and high-performance mechanical switches. Mini-Circuits' smart modular controller provides a single interface to your system, with complete software and applications support.

Key Benefits

- Built to order with fast turnaround
- Three chassis options with customizable hardware windows
- Your choice of switch modules from SPDT to SP8T
- Frequency ranges up to 50 GHz
- Configure your system online for a free quote!

Configure Your System Online

Visit our website to visualize your modular switch system in a few easy steps, then submit your configuration and online to receive a full quote and specification:

- RCM series compact benchtop housing
minicircuits.com/WebStore/rcm
- ZTM series 3U rack chassis
minicircuits.com/WebStore/ztm
- ZTM2 series 5U rack chassis
minicircuits.com/WebStore/ztm2

Configure and Quote

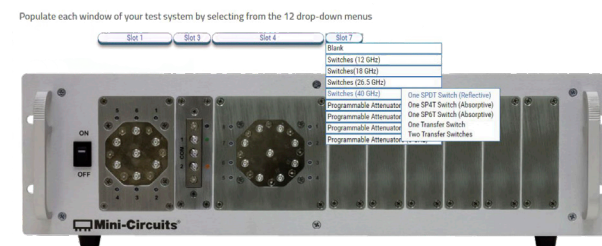

Popular Benchtop Configurations (RCM-Series)

Starting from \$3,250

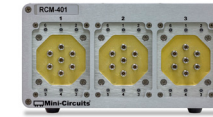

RCM-401

3 x SP6T (40 GHz)

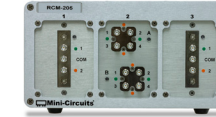

RCM-205

2 x SPDT + 2 x DPDT (18 GHz)

Popular 3U Rack-Mounted Configurations (ZTM-Series)

Starting from \$5,050



ZTM-97

4 x SP4T (40 GHz)
2 x SPDT (40 GHz)

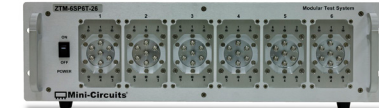

ZTM-6SP6T-26

6 x SP6T (26.5 GHz)

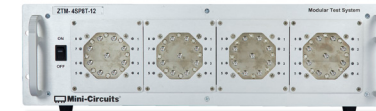

ZTM-4SP8T-12

4 x SP8T (12 GHz)



ZTM-93

8 x SPDT (18 GHz)
2 x SP6T (12 GHz)

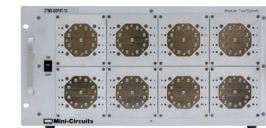

ZTM2-8SP8T-12

8 x SP8T (12 GHz)

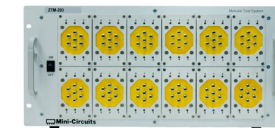

ZTM-203

12 x SP6T (40 GHz)

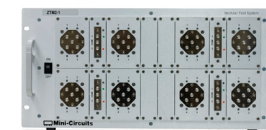

ZTM2-1

8 x SP4T (18 GHz)
4 x SPDT (18 GHz)

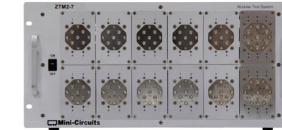

ZTM2-7 >>

10 x SP4T (18 GHz)
2 x SP6T (12 GHz)



Mechanical Switch Arrays

Starting from \$1,995

Overview

Mini-Circuits' purpose-built mechanical switch array racks can be configured according to your exact specifications. Our catalog includes a wide range of standard switch configurations that may solve your problem without the need for development time, but if you don't see a configuration that works for you, get in touch and our applications engineering team will work with you to develop the right solution.

Key Benefits

- Wide selection of switches from SPDT to SP8T
- Options up to 50 GHz
- Rugged 19" rack-mount chassis
- USB and Ethernet control options

Featured Systems

ZT-310

- 32 x DPDT / transfer switches
- DC to 18 GHz
- Switches mounted on front and rear panels
- Control via Ethernet and USB
- Daisy-chain stacking of systems supported. Allows multiple systems to be linked together and controlled through a single interface



ZT-14SP6T-40

- 14 independent SP6T switches
- DC to 40 GHz
- Arranged in star configuration on front panel
- Dual SP36T application with external interconnect cables
- Control via Ethernet and USB



Electromechanical Switch Systems — Featured Configurations

Model Number	Switch Count					Application	Frequency	Rack Height	Insertion Loss (dB)	
	DPDT	SPDT	SP4T	SP6T	SP8T				Type	Panel
ZTRC-4SPDT-A26	-	4	-	-	-	Switch Rack	DC - 26.5 GHz	1U	SMA	Front
ZTRC-4SPDT-A18	-	4	-	-	-	Switch Rack	DC - 18 GHz	1U	SMA	Front
ZTRC-8SPDT-A18	-	8	-	-	-	Switch Rack	DC - 18 GHz	2U	SMA	Front
ZTRC-8SPDT-A26	-	8	-	-	-	Switch Rack	DC - 26.5 GHz	2U	SMA	Front
ZT-12SP6T-12R	-	-	-	12	-	Switch Rack	DC - 12 GHz	4U	SMA	Rear
ZT-311	-	4	-	8	-	4 x SP12T Switch	DC - 12 GHz	4U	SMA	Rear
ZT-SP36T-12A	-	-	-	-	-	SP36T Switch	DC - 12 GHz	4U	SMA	Front
ZTM2-12SP4T-18	-	-	12	-	-	Switch Rack	DC - 18 GHz	5U	SMA	Front
ZTM2-12SP6T-12	-	-	-	12	-	Switch Rack	DC - 12 GHz	5U	SMA	Front
ZTM2-8SP8T-12	-	-	-	-	8	Switch Rack	DC - 12 GHz	5U	SMA	Front
ZTMX-5SP4T-40	-	-	5	-	-	Switch Rack	DC - 40 GHz	3U	2.92 mm	Front
ZT-1SP8T-26	-	-	-	-	1	Switch Rack	DC - 26.5 GHz	3U	SMA	Front
ZTM-6SP6T-26	-	-	-	6	-	Switch Rack	DC - 26.5 GHz	3U	SMA	Front
ZTM-4SP8T-12	-	-	-	-	4	Switch Rack	DC - 12 GHz	3U	SMA	Front
ZT-14SP6T-40	-	-	-	14	-	2 x SP36T Switch	DC - 40 GHz	6U	2.92 mm	Front
ZT-166	-	1	10	-	-	SP32T Switch	DC - 18 GHz	4U	SMA	Front
ZT-297	-	-	-	-	9	Switch Rack	DC - 12 GHz	4U	SMA	Front
ZT-317	-	3	-	-	-	Switch Rack	DC - 18 GHz	1U	N-type	Rear
ZT-310	32	-	-	-	-	Switch Rack	DC - 18 GHz	5U	SMA	Front & Rear
ZT-315	-	-	1*	-	5	SP40T Switch	DC - 18 GHz	3U	SMA	Front
ZT-169	-	4	10	-	-	4 x SP8T & 2 x SPDT	DC - 18 GHz	4U	SMA	Front
ZTM-12MTS-26	12	-	-	-	-	Switch Rack	DC - 26.5 GHz	3U	SMA	Front

Solid State Switches

Overview

Mini-Circuits' solid-state switch modules are ideal for applications requiring fast switching times and bullet-proof reliability. Options from SPDT to SP16T are available from stock, with some models operating up to 40 GHz.

Our solid-state design approach achieves superior isolation performance, combining some of the benefits typically reserved to mechanical switches with the speed and longer life of semiconductor-based designs. Ideal for sensitive test applications where signal selectivity is critical!

Key Benefits

- Ultra-high reliability with long switching life
- Switch transition time as fast as 5 ns
- Daisy-chain configuration simplifies control systems

Simplify Your Control System

The USB interface with full software support makes integrating switches into computer-controlled test systems a simple case of "plug and play." No need to spend time developing custom micro-controller implementations and software drivers.

TTL, SPI and I2C control options are also available on specific models where direct logic control interfaces are preferred.



Daisy Chain Control of Multiple Switches

The additional serial control ports on selected models support Mini-Circuits' daisy-chain control feature with "dynamic addressing." This simplifies control systems by allowing multiple switches to be combined into a master-slave chain. Simply connect, then power on and the whole chain of compatible switches can be controlled independently through a single USB connection and software interface.

SPI Timing Diagram for 3 units in series

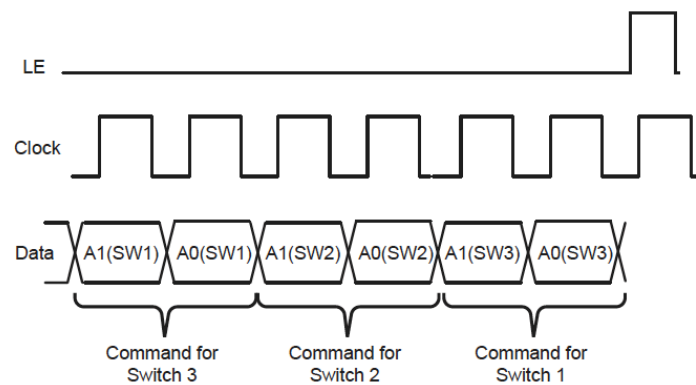

Standard Models

Model Number	Switch Type	Frequency	Switch Count	Insertion Loss	Isolation	Transition Time	Input Power	Control Interface
U2C-1SP2T-63VH	SPDT	10 - 6000 MHz	1	4 dB	110 dB	700 ns	36 dBm	USB / I ² C / SPI
USB-4SP2T-63H	SPDT	10 - 6000 MHz	4	2 dB	80 dB	250 ns	30 dBm	USB
USB-2SP2T-DCH	SPDT	DC - 8000 MHz	2	1.4 dB	50 dB	10 μs	35 dBm	USB
USB-1SP2T-183	SPDT	100 MHz - 18 GHz	1	2 dB	65 dB	50 ns	25 dBm	USB
USB-1SP2T-A44	SPDT	100 MHz - 43.5 GHz	1	3 dB	50 dB	5 ns	24 dBm	USB
U2C-1SP4T-63H	SP4T	2 - 6000 MHz	1	3.7 dB	80 dB	250 ns	30 dBm	USB / I ² C
USB-SP4T-63	SP4T	1 - 6000 MHz	1	1 dB	50 dB	3 μs	27 dBm	USB
USB-2SP4T-63H	SP4T	10 - 6000 MHz	2	2.5 dB	85 dB	5 μs	30 dBm	USB
USB-1SP4T-183	SP4T	100 MHz - 18 GHz	1	4 dB	65 dB	20 ns	25 dBm	USB
USB-1SP8T-63H	SP8T	10 - 6000 MHz	1	4 dB	80 dB	250 ns	30 dBm	USB
USB-1SP8T-183	SP8T	100 MHz - 18 GHz	1	4.5 dB	65 dB	50 ns	25 dBm	USB
USB-1SP16T-83H	SP16T	1 - 8000 MHz	1	7.5 dB	100 dB	5 μs	30 dBm	USB / TTL

Solid State Switch Racks

Starting from \$12,655

Overview

Leverage Mini-Circuits' full range of high-performance solid-state switches to simplify your production test racks, integrating your required switch configuration within a convenient rack-mountable chassis with a single Ethernet / USB control interface.

Popular configurations are available from our catalog without special development effort, and custom systems are available on request. Our novel daisy-chain interface can also be included, enabling multiple switch racks to be stacked so that all control is managed through a single software interface.



Featured Systems

ZTS-1SP80T-63H

- Single SP80T switch, 10-6000 MHz
- N-type input & SMA outputs
- Control via Ethernet & USB
- Daisy-chain stacking interface



ZTS-16SP4T-63H

- 16 x SP4T switches, 10-6000 MHz
- SMA connectors on front panel
- Control via Ethernet & USB
- Daisy-chain stacking interface



ZTS-6SP8T-63R

- 6 x SP8T switches, 10-6000 MHz
- All SMA connectors on rear panel
- High isolation
- Control via Ethernet & USB



Standard Models

Model Number	Switch Type	Frequency	Switch Count	Rack Height	Connectors	Panel	Control
ZT-24SP2T-63VH	SPDT	600 - 6000 MHz	24	4U	N-type	Front & Rear	USB & Ethernet
ZTS-32SP2T-63VH		100 - 6000 MHz	32	5U	SMA	Front	USB & Ethernet
ZTS-16SP4T-63H	SP4T	10 - 6000 MHz	16	2U	SMA	Front	USB & Ethernet Daisy-Chain
ZTS-6SP8T-63R	SP8T	10 - 6000 MHz	6	3U	SMA	Rear	USB & Ethernet
ZTS-8SP8T-63		10 - 6000 MHz	8	4U	SMA	Front	USB & Ethernet
ZT-320		1 - 6000 MHz	30	3U	SMA	Rear	USB & Ethernet & Daisy-Chain
ZTS-1SP16T-83R		SP16T	1 - 8000 MHz	1	1U	SMA	Rear
ZTS-1SP80T-63H	SP80T	10 - 6000 MHz	1	2U	SMA	Front & Rear	USB & Ethernet & Daisy-Chain

Simplify your switch rack control system using Mini-Circuits' novel daisy-chain stacking system:

1. Connect together multiple solid-state switch racks using the serial In and Out connectors
2. Automatically create a single "stacked" system, by powering on each rack
3. Connect a single USB or Ethernet connection to the "Master" unit for control
4. Easily manage and control every switch in the stack through a single software GUI or API

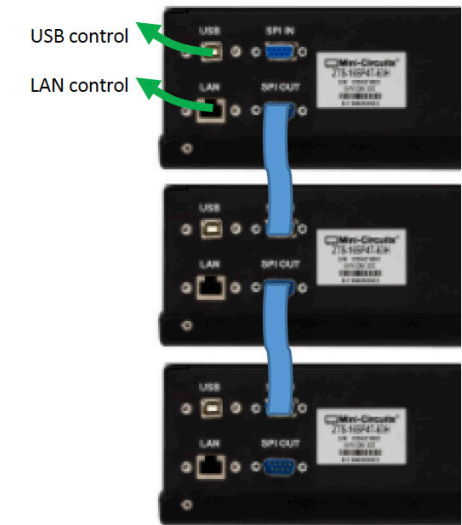

Switch Matrices

Overview

Our integrated switch matrices provide reliable and repeatable signal routing for any application. Blocking, non-blocking and full fan-out switch matrices are available using many combinations of mechanical and solid-state switch technologies to meet your unique system requirements.

Key Benefits

- Blocking, non-blocking and full-fanout configurations
- Ideal for managing complex signal traffic
- Combinations of mechanical and solid state switches for optimal performance



Non-Blocking Switch Matrices

Starting from \$11,825

Fan-Out Operation:

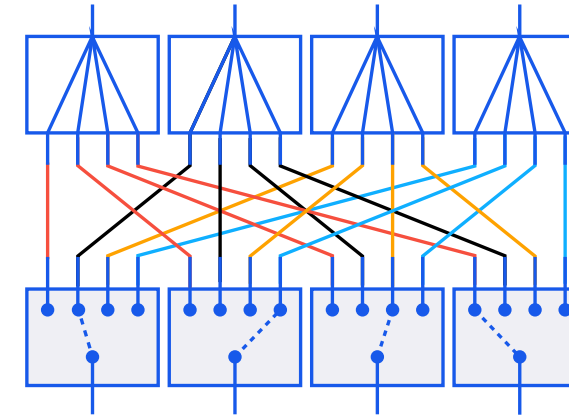

Construction

- Splitters on inputs, switches on outputs

Switch Path Combinations

- One to many
- Each path connects a single input to any combination of outputs
- The input port can be used by multiple active paths
- The output ports can't be used by any other active paths

Advantages

- Multiple devices on the outputs can be driven by the same input

Common Applications:

- Receiver Testing

Fan-In Operation:

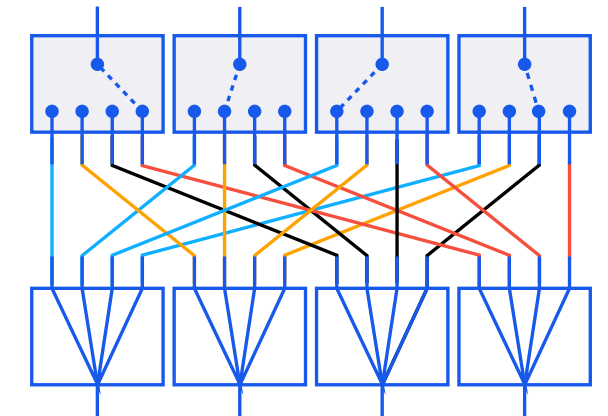

Construction

- Switches on inputs, splitters on outputs

Switch Path Combinations

- Many to one
- Each path connects any combination of inputs to a single output
- The input ports can't be used by any other active paths
- The output port can be used by multiple active paths

Advantages

- Multiple devices on the inputs can feed the same output

Common Applications:

- Transmitter testing

Switch Matrix Configurations: Comparison Matrix

Feature	Blocking	Non-Blocking	Full Fan-Out
Each path can connect a single input to a single output	Yes	Yes	Yes
Each path can connect a single input to multiple outputs	No	Yes	Yes
Each path can connect multiple inputs to multiple outputs	No	No	Yes
Insertion Loss	Lowest	Medium	Highest
Variable Path Loss	No	No	Yes
Power Rating	Highest	Medium	Medium

Non-Blocking Switch Matrices Continued

Standard Configurations

Model Number	Frequency	Configurations	Impedance	Height	Connectors	Control
ZT-177	400 - 6000 MHz	4 x 4	50	3U	SMA	USB & Ethernet
ZT-10X6NB	600 - 6000 MHz	10 x 6	50	5U	N-type	USB & Ethernet & Touchscreen
ZT-20X6NB		20 x 6	50	5U	SMA	
ZT-10X30NB	600 - 6000 MHz	10 x 30	50	4U	SMA	USB & Ethernet & Touchscreen
ZT-80X30NB		80 x 30	50	38U	SMA	

Close-Up: ZT-10X30NB

High-performance 10 x 30 non-blocking switch matrix

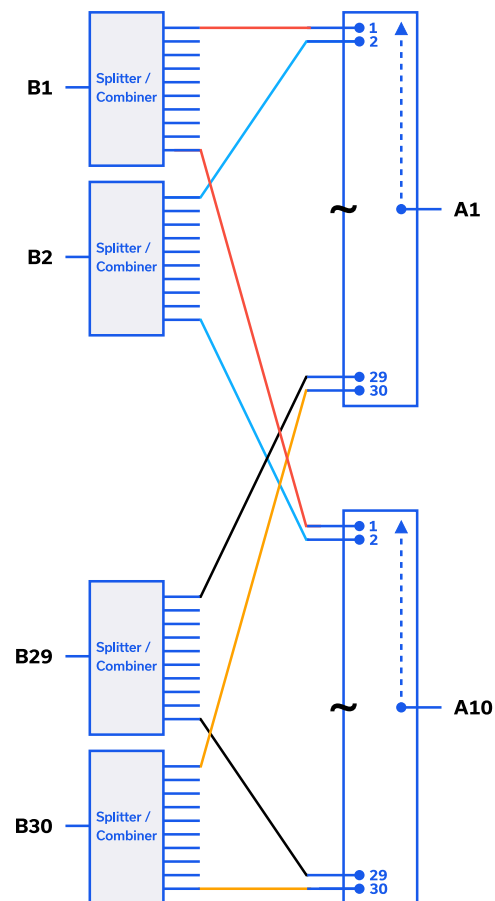

- Bi-directional operation
- Any of the 10 "A" ports can connect to any combination of the 30 "B" ports
- Ideally suited to cellular test systems
- Allows 30 separate test stations to access any of 10 base-station channels, without affecting any other test stations.

Parameter	Conditions	Min	Typ	Max	Units
Frequency	-	600	-	6000	MHz
Path Loss	600-3000 MHz	-	23	25	dB
	3000-6000 MHz	-	26	30	
Isolation-Inactive Paths	600-3000 MHz	60	80	-	dB
	3000-6000 MHz	55	70	-	
Return Loss	-	-	None	-	dB

Blocking Switch Matrices

Starting from \$11,845

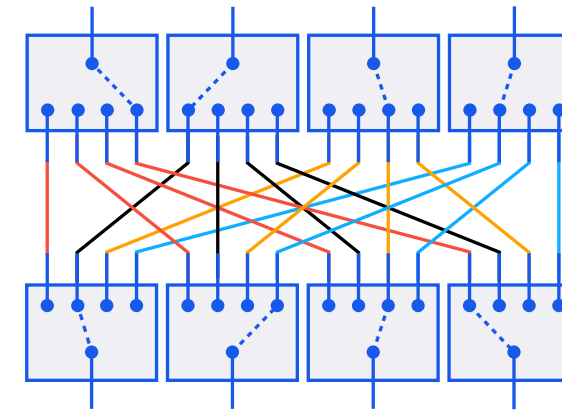

Construction

- Switches on inputs and outputs

Switch Path Combinations

- One-to-one
- Each path connects a single input to a single output
- The input and output can't be used by any other active paths
- Bi-directional operation

Advantages

- Broadest frequency range options
- Lowest insertion loss

Common Applications:

- Multi-channel / MIMO / LTE radio testing
- Satcom signal routing
- Component characterisation / qualification testing
- VNA extension

Blocking Standard Configurations

Model Name	Frequency	Configuration	Impedance	Height	Connectors	Control
ZTVX-10-75-N	5 - 2500 MHz	2 x 10	75	4U	N-type	USB & Ethernet
ZTVX-12-75-N		2 x 12		4U		
ZTVX-16-75-N		2 x 16		4U		
ZTVX-8-75-N		2 x 8		3U		
ZT-16X48B	600 - 6000 MHz	16 x 48	50	14U	SMA	USB & Ethernet
ZT-24X48B		24 x 48		48U		
ZT-24X8B		24 x 8		5U		
ZTVX-8-12-S	DC - 12000 MHz	2 x 8	50	2U	SMA	USB & Ethernet
ZTVX-10-12-S		2 x 10		2U		
ZTVX-12-12-S		2 x 12		2U		
ZTVX-16-12-S		2 x 16		2U		
ZTVX-32-12-S		2 x 32		4U		
ZT-6X3B	DC - 12000 MHz	6 x 3	50	3U	SMA	USB & Ethernet
ZT-175		6 x 8		4U		
ZTVX-8-18-S	DC - 18000 MHz	2 x 8	50	2U	SMA	USB & Ethernet
ZTVX-10-18-S		2 x 10		2U		
ZTVX-12-18-S		2 x 12		2U		
ZTVX-16-18-S		2 x 16		2U		
ZT-8X8B-1835	DC - 18000 MHz	8 x 8	50	4U	SMA	USB & Ethernet

Close-Up: ZTVX-16-18-S

Broadband 2x16 Blocking Switch Matrix

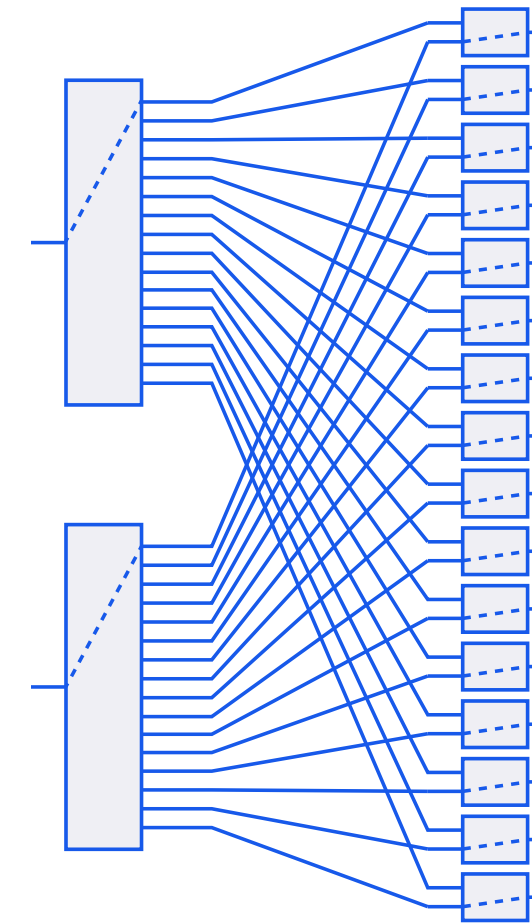
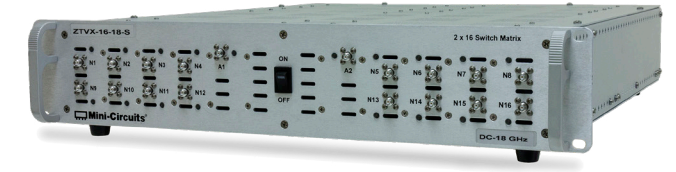

Broadband 2 x 16 blocking switch matrix, operating up to 18 GHz. The low loss, high isolation and blocking configuration with 2 active paths lends itself to use as a VNA extender:

- Extension of a 2-port VNA to multiple DUT
- Characterisation of multi-port devices
- Testing of MIMO systems with high channel counts
- 2 x 8, 2 x 10, 2 x 12, 2 x 16 and 2 x 32 configurations available

Parameter	Conditions	Min	Typ	Max	Units
Frequency	-	DC	-	18	GHz
Path Loss	DC - 8 GHz	-	1.2	-	dB
	8-18 GHz	-	2.0	-	
Isolation-Inative Paths	DC - 8 GHz	-	100	-	dB
	8-18 GHz	-	90	-	
Return Loss	-	-	15	-	dB
Input Power	Per port	-	-	30	dBm

Fully Non-Blocking / Full Fan-Out Attenuator Matrices

Starting from \$35,125

Overview

“Full fan-out” or “fully non-blocking” systems use a combination of programmable attenuators and splitter / combiners to provide a completely flexible set of paths between a group of input and output ports. Similar to a switch matrix except any individual path can be “on” (0 dB attenuation), or “off” (max attenuation), or any attenuation value in-between. In addition, all inputs can connect simultaneously to all outputs, and all paths are bi-directional. This completely flexible set of characteristics provides a powerful matrix for test environments.

Key Benefits

- Many-to-many configuration—all inputs can connect to all outputs simultaneously
- Programmable attenuators on every channel to vary path loss
- Ideal for transceiver / handover test systems

Construction

- Splitter/combiners on inputs and outputs
- Programmable attenuators used for path “switching” and signal level control

Switch Path Combinations

- Many to many
- Each path connects any combination of inputs to any combination of outputs
- All input and output ports can be used by multiple active paths

Advantages

- Completely flexible path combinations
- Programmable attenuators allow precise signal level, rather than just on or off
- Multiple devices on the inputs can feed the same output
- Multiple devices on the outputs can be driven by the same input

Common Applications

- Transmitter & receiver testing
- Cellular handover testing
- Massive MIMO

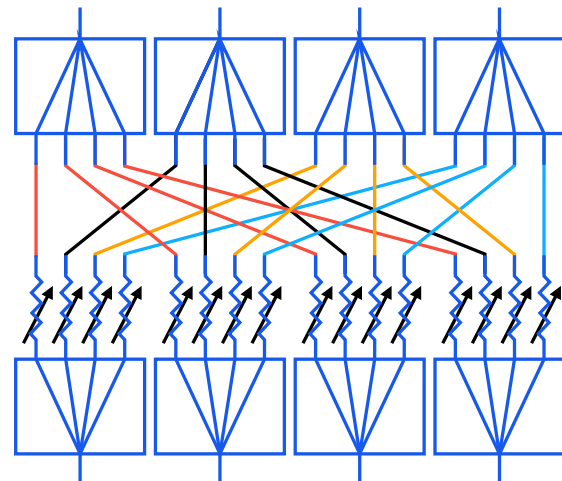

Fully Non-Blocking Standard Configurations

Model Name	Frequency	Configuration	Attenuation	Height	Connectors	Control
ZT-24RFX8	500 - 6000 MHz	24 x 8	0-63 dB	5U	SMA	USB & Ethernet & Daisy-Chain
ZT-16RFX8		16 x 8		5U		
ZT-8RFX8		8 x 8		3U		

Close-Up: ZT-8RFX8

8x8 Full Fan-Out / Fully Non-Blocking Matrix

- Operation from 500 MHz to 6 GHz
- USB & Ethernet control



Path Loss at Attenuation Steps:

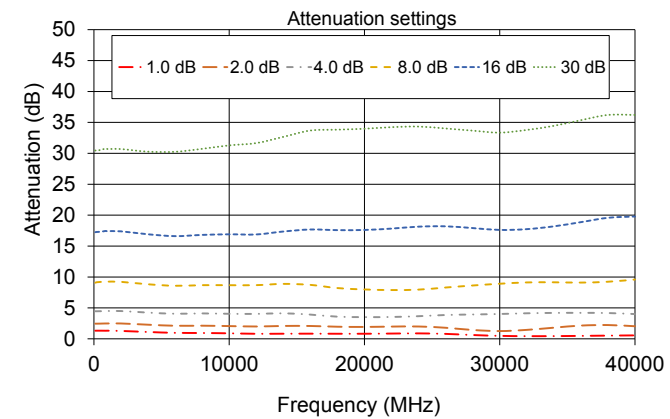

Functional Schematic:

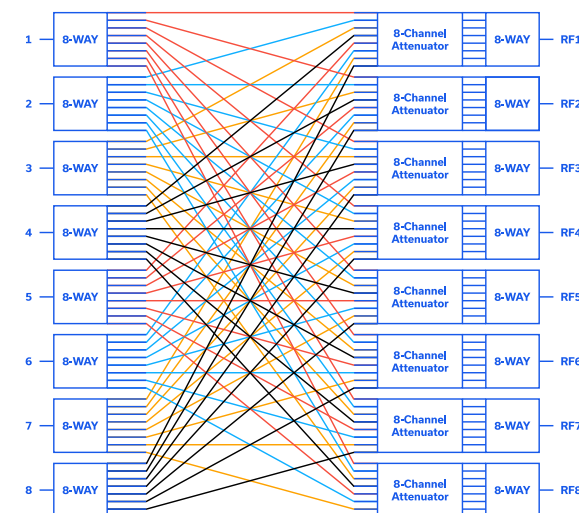

Parameter	Conditions	Min	Typ	Max	Units
Frequency	-	500	-	6000	MHz
Path Loss	500 - 3000 MHz	-	23	28	dB
	3000 - 6000 MHz	-	28	34	
Return Loss	500 - 3000 MHz	-	18	-	dB
	3000 - 6000 MHz	-	13	-	
Attenuation Range	Per path, 0.25 dB steps	0	-	63	dB
Isolation (between adjacent ports @ 0 dB)	500 - 3000 MHz	45	52	-	dB
	3000 - 6000 MHz	48	57	-	
Isolation (in <-> out @ 63 dB)	500 - 3000 MHz	-	83	-	dB
	3000 - 6000 MHz	-	90	-	
Input Power	-	-	-	+20	dBm

Signal Conditioning & Attenuation

Our programmable attenuator product line provides versatile solutions for automating signal level control, simulating the effects of signal fading and a number of other useful functions. Our programmable attenuators offer outstanding accuracy, even at the highest attenuation settings and wide frequency ranges up to 50 GHz. These devices may be used individually or integrated into multi-channel systems for higher-volume setups.

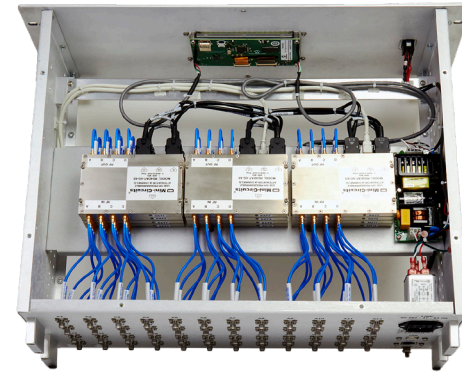

Programmable Attenuators Off the Shelf

Overview

Mini-Circuits' compact programmable attenuators are designed with wide attenuation ranges and fine step sizes, for precise signal level control. Coupled with our standard USB & Ethernet control interfaces, these devices are easily integrated into any test system for simulation of transmission loss, signal fading, cross talk and power level calibration.



Key Benefits

- Frequency range up to 50 GHz
- Attenuation range up to 120 dB
- Step size as small as 0.05 dB
- Automation via Ethernet or USB

Common Applications

- Transmission loss simulation
- LTE / 4G / 5G network infrastructure
- IoT / Bluetooth / Zigbee / Wi-Fi 6E
- Power level cycling

Catalog Models

Model Number	Frequency	Attenuation Range (dB)	Attenuation Steps (dB)	Input Power	Control
ZVVA-3000	20 MHz - 3 GHz	0 - 25	0.1	+23 dBm	USB & RS232
RCDAT-3000-63W2	50 MHz - 3 GHz	0 - 63	1	+33 dBm	USB & Ethernet
RCDAT-4000-120	1 MHz - 4 GHz	0 - 120	0.25	+20 dBm	USB & Ethernet
RCDAT-6000-30	1 MHz - 6 GHz	0 - 30	0.25	+20 dBm	USB & Ethernet
RCDAT-6000-60		0 - 60			
RCDAT-6000-90		0 - 90			
RCDAT-6000-110		0 - 110			
RCDAT-6G-120H	200 MHz - 6 GHz	0 - 120	0.05	+23 dBm	USB & Ethernet
RCDAT-8000-30	1 MHz - 8 GHz	0 - 30	0.25	+28 dBm	USB & Ethernet
RCDAT-8000-60		0 - 60			
RCDAT-8000-90		0 - 90			
RCDAT-8G-120H	200 MHz - 8 GHz	0 - 120	0.05	+24 dBm	USB & Ethernet & Daisy-Chain
RUDAT-13G-60	10 MHz - 13 GHz	0 - 60	0.5	7.5 dB	USB, SPI & RS232
RUDAT-13G-90		0 - 90			
RCDAT-18G-63	100 MHz - 18 GHz	0 - 63	0.25	4 dB	USB & Ethernet & Daisy-Chain & TTL
RCDAT-30G-30	100 MHz - 30 GHz	0 - 30	0.5	7.5 dB	USB & Ethernet & Daisy-Chain
RCDAT-40G-30	100 MHz - 40 GHz	0 - 30	0.5	4 dB	USB & Ethernet & Daisy-Chain
RCDAT-50G-30	100 MHz - 50 GHz	0 - 30	0.5	7.5 dB	USB & Ethernet & Daisy-Chain

Programmable Attenuators Off the Shelf Continued

Close-Up: RCDAT-8G-120H

Key Features:

- 0 to 120 dB attenuation range with 0.05 dB steps!
- Operation from 200 MHz to 8 GHz
- USB & Ethernet control

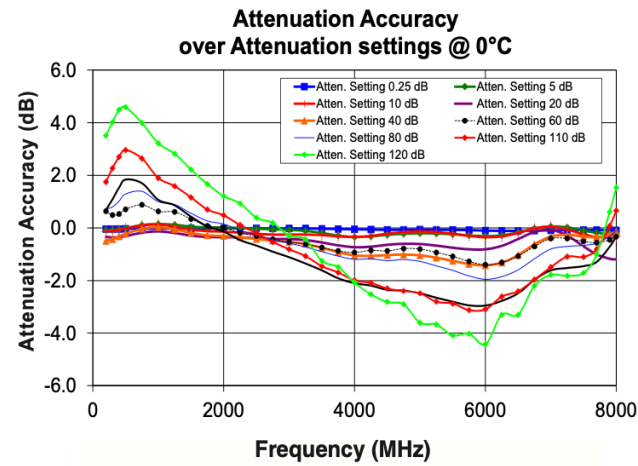

Close-Up: RCDAT-40G-30

Key Features:

- Consistent attenuation up to 40 GHz!
- 0-30 dB programmable attenuation in 0.5 dB steps
- USB & Ethernet control
- Daisy-chain up to 25 attenuators via single control interface

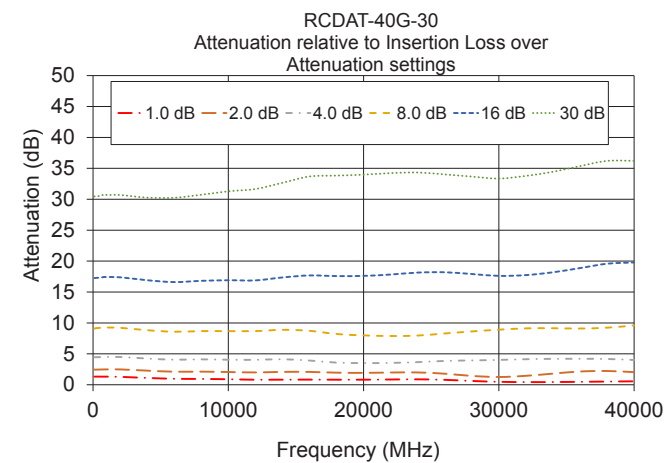

Multi-Channel Attenuators Off the Shelf

Compact Modules

Overview

Mini-Circuits' RC4DAT (4-channel) and RC8DAT (8-channel) series programmable attenuators are the perfect solution for multi-channel and multi-device test systems.

Each model combines 4 or 8 independently controllable attenuation channels in one compact package, with high isolation of cross-talk between channels. All channels are controlled through a single interface.



Key Benefits

- Multiple independently controlled channels in a single, compact module
- Frequency range up to 8 GHz
- Attenuation range up to 120 dB
- Step size as small as 0.05 dB

Common Applications

- Cellular handover testing
- MIMO verification
- Mesh network testing

Multi-Channel Attenuators — Catalog Models

Model Number	Frequency	Channel	Attenuation Range (dB)	Attenuation Steps (dB)	Input Power	Control
RC4DAT-6G-30	1 MHz - 6 GHz	4	0 - 30	0.25	23 dBm	USB & Ethernet
RC4DAT-6G-60			0 - 63			
RC4DAT-6G-95			0 - 95			
RC4DAT-8G-95	1 MHz - 8 GHz	4	0 - 95	0.25	28 dBm	USB & Ethernet
RC4DAT-8G-120H			0 - 120			
RC8DAT-8G-95	1 MHz - 8 GHz	8	0 - 95	0.25	28 dBm	USB & Ethernet

Rack-Mount Systems

Starting from \$15,495

Overview

Our ZTDAT-series attenuator racks cater to test systems where a greater number of programmable channels are required. With models operating up to 8 GHz and up to 48 channels per system, most wireless test applications in the L, S and C bands can be accommodated.

Key Benefits

- 19" rack mount chassis
- Up to 48 channels per system
- Daisy chain multiple systems for more channels from a single interface

Daisy Chain Control Stacking

Multiple units can be configured into a single system using Mini-Circuits' daisy-chain stacking interface, allowing 100s of attenuator channels to be controlled through a single USB or Ethernet connection.

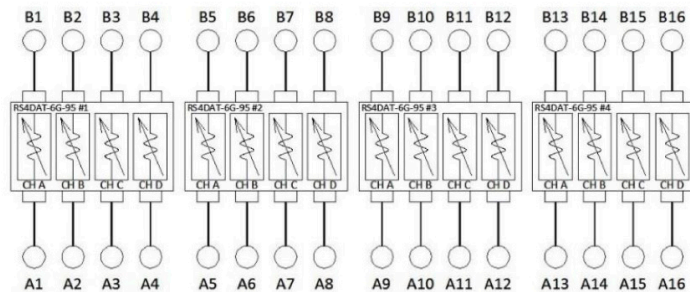
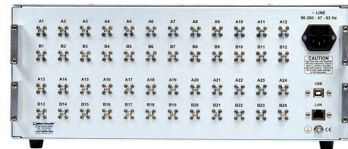

Rack Mount Attenuation Systems — Standard Configurations

Model Name	Frequency	Channels	Attenuation	Rack	Connectors	Panel	Control		
ZTDAT-8-6G30S	1 - 6000 MHz	8	0 - 30 dB	1U	SMA	Front & Rear	USB & Ethernet & Daisy-Chain		
ZTDAT-8-6G63SR			0 - 63 dB	1U	SMA	Rear			
ZTDAT-8-6G95S			0 - 95 dB	1U	SMA	Front & Rear			
ZTDAT-8-6G95SR			0 - 95 dB	1U	SMA	Rear			
ZTDAT-12-6G30S		12	0 - 30 dB	1U	SMA	Front & Rear			
ZTDAT-12-6G95S			0 - 95 dB	1U	SMA	Front & Rear			
ZTDAT-12-6G95SR			0 - 95 dB	2U	SMA	Rear			
ZTDAT-16-6G63S			0 - 63 dB	1U	SMA	Front & Rear			
ZTDAT-16-6G9543		16	16	0 - 95 dB	2U	4.3-10		Front & Rear	
ZTDAT-16-6G95N					2U	N-Type		Front & Rear	
ZTDAT-16-6G95S					1U	SMA		Front & Rear	
ZTDAT-24-6G95S					2U	SMA		Front & Rear	
ZTDAT-8-8G95S		1 - 8000 MHz	8	0 - 95 dB	1U	SMA		Front & Rear	USB & Ethernet & Daisy-Chain
ZTDAT-16-8G95S			16		1U	SMA		Front & Rear	

Targeted Solutions & Use Cases

In addition to hundreds of general-purpose test systems, Mini-Circuits has developed several solutions based on common test use cases in the market. Our solutions include multiple options for simulating real-world signal conditions in the lab environment, high-power test systems to scale up throughput for burn-in testing and more.

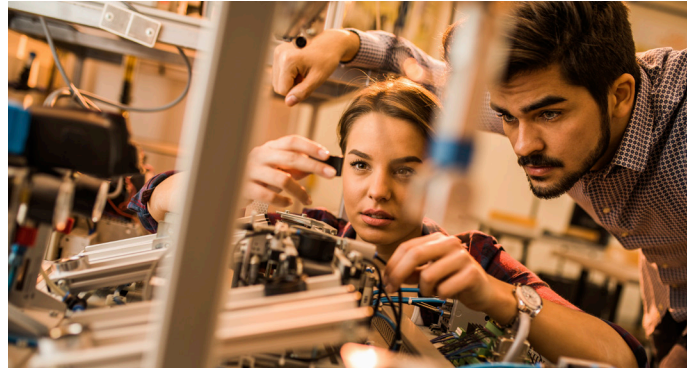

Cellular Handover Test Systems

Overview

Testing of multi-band cellular systems typically requires a test environment capable of combining and varying signals from multiple radios and interferers into the device (or devices) under test. Mini-Circuits has a range of handover test systems combining programmable attenuators and power splitters and combiners for this purpose. These configurations allow simulation of "real-world" conditions for wireless handsets, radio-heads, antenna systems, base-stations and nodes.

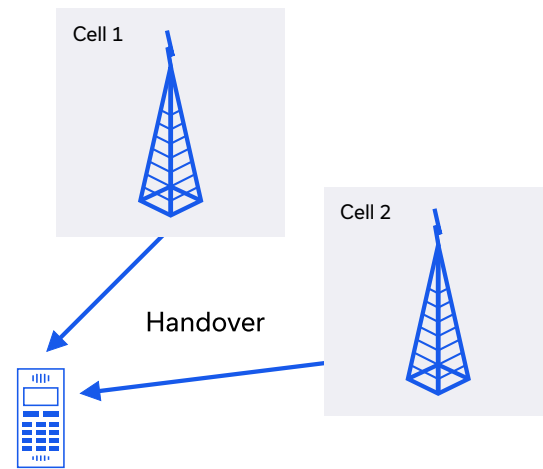

Key Benefits

- Simulates distance and signal transition in a lab environment
- Independently controlled attenuation on every channel
- Expandable by connecting multiple units in daisy chain configuration

Typical applications include:

1. Varying path loss between a wireless device and node during transmission
2. Hand-over from one node to another as a wireless device moves out of range
3. Verification of device performance in the presence of multiple radio signals and interferers

Cellular Handover Test Standard Configurations

Model Name	Frequency	Inputs	Outputs	Attenuation	Height	Connectors	Control
ZT-279	500 - 6000 MHz	2	4	0 - 95 dB	1U	SMA	USB & Ethernet & Daisy-Chain
ZT-278	500 - 6000 MHz	4	32		3U	SMA	
ZT-217	600 - 6000 MHz	3	20		4U	N-type	
ZT-217-S	600 - 6000 MHz	3	20		4U	SMA	

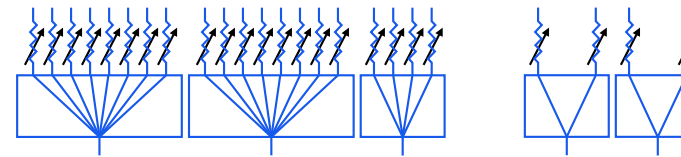

ZT-217 and ZT-217-S

ZT-279

Close-Up: ZT-278

4-Input to 32-Output Matrix

Key Features:

- Independent 0-95 dB attenuation per output
- Operation from 500 MHz to 6 GHz
- USB & Ethernet control

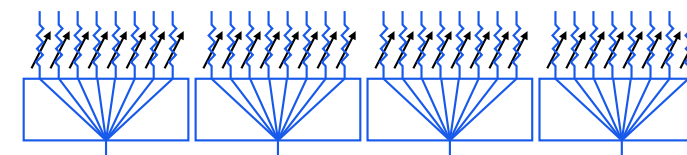

Parameter	Conditions	Min	Typ	Max	Unit
Frequency	-	500	-	6000	MHz
Insertion Loss	Attenuation = 0 dB	-	18	22	dB
Return Loss	-	-	12	-	dB
Isolation	Between outputs of the same splitter	22	35	-	dB
	Between adjacent input ports	90	100	-	
Attenuation Range	0.25 dB Steps	0	-	90	dB
	0.50 dB Steps	90	-	95	
Input Power	RF-A, RF-B, RF-C, RF-D	-	-	+30	dBm
	A1-8; B1-8; C1-8; D1-8	-	-	+23	

Mesh Network Simulation Racks

Starting from \$10,495

Overview

Mini-Circuits has developed a range of test systems for characterizing wireless mesh network devices. All external ports of the mesh are interconnected to simulate an over-the-air wireless mesh configuration. Programmable attenuators on each internal path allow the path loss to be varied independently between any pair of devices, without affecting communication between any other pair.

This configuration allows the simulation of real-world mesh characteristics within a confined lab or production environment, including:

1. Receiver sensitivity
2. Changes in range between devices
3. Performance in the presence of interfering signals
4. Ability of devices to relay signals between nodes

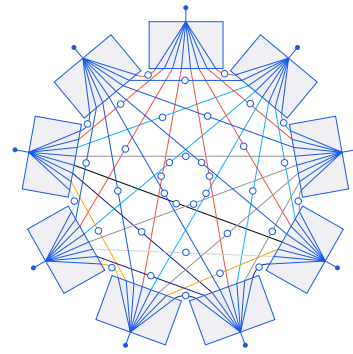

Key Benefits

- Configurations from 3 to N ports
- Independently controlled attenuation on every path
- Frequency range up to 40 GHz
- Attenuation range up to 120 dB

Common Applications

- R&D testing of wireless "smart" devices
- Bluetooth, Zigbee, Z-Wave, WiFi, IoT
- Qualification / acceptance testing of military radios
- UHF / VHF band man-pack / vehicular systems
- PMR / TETRA

Close-Up: ZTMN-0895A-S

8-port mesh network
UHF / VHF bands (30-3000 MHz)

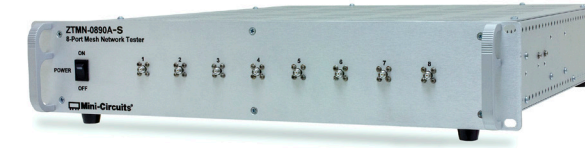

Parameter	Conditions	Min	Typ	Max	Unit
Frequency	-	30		3000	MHz
Insertion Loss	-	-	33	-	dB
Return Loss	-	-	12	-	dB
Attenuation Range	0.25 dB steps	0	-	90	dB
	0.5 dB steps	90	-	95	
Input Power	Per path	-	-	+27	dBm

Close-Up: ZTMN-0695C-S

6-port mesh network
Covers WiFi bands (including WiFi 6E)



Parameter	Conditions	Min	Typ	Max	Unit
Frequency	-	2000		8000	MHz
Insertion Loss	-	-	30	-	dB
Return Loss	-	-	17	-	dB
Attenuation Range	2000-7200 MHz	0	-	95	dB
	7200-8000 MHz	0	-	90	
Input Power	Per path	-	-	+25	dBm

Mesh Network Test Standard Configurations

Model Name	Frequency	Ports	Attenuation	Height	Connectors	Control
ZTMN-0495AS	350 - 6000 MHz	4		2U	SMA	
ZTMN-0695A-T	2000 - 6000 MHz	6		2U	TNC	
ZTMN-0695B-S	600 - 6000 MHz	6		2U	SMA	
ZTMN-0695C-S	2000 - 8000 MHz	6	0 - 95 dB	2U	SMA	USB & Ethernet
ZTMN-0895A-S	30 - 3000 MHz	8		2U	SMA	
ZTMN-0895B-S	500 - 6000 MHz	8		3U	SMA	
ZTMN-0995A-S	500 - 6000 MHz	9		3U	SMA	

Custom Mesh Configurations

Custom frequency, port and connector configurations can be provided on request.

Number of Ports	Number of Paths
4	6
6	15
8	28
9	36
16	120
32	496

High Power Test Systems

Overview

Mini-Circuits provides all the key building blocks needed for creation of high-power RF test systems. Our off the shelf 100W saturated output power amplifiers can be combined with signal sources, distribution systems and loads to create complete integrated test systems.

Key Benefits

- Signal sources, amplifiers and distribution systems
- Distribute signal up to 100W into multiple channels

High Power Test Applications

- HTOL (high temperature operating life)
- General burn-in / RF stress testing
- EMC / EMI testing

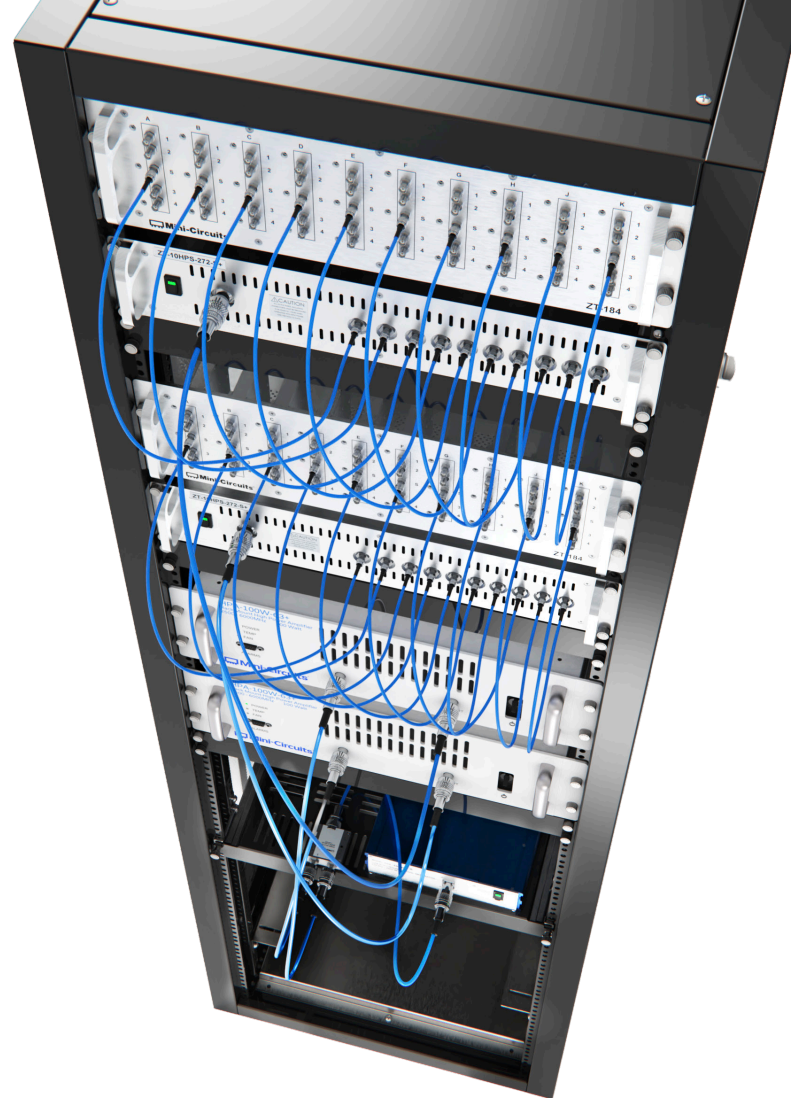

High-Power Passive Systems

Key Benefits

- Rack-mountable splitters rated up to 100W
- High power attenuator / load boxes
- High power switch systems



Featured Systems

Model Name	Frequency (MHz)	Power (W)	Rack Height	Description
ZT-184	500 - 6000	30	3U	10 x 4-way splitter / combiner panel
ZT-10HPS-272	700 - 2700	100	2U	10-way high power splitter
ZT-16HPS-63W-S	700 - 6000	100	2U	16-way high power splitter
ZT-20HPS-63-S	2500 - 6000	100	2U	20-way high power splitter
ZT-337	DC - 6000	100	3U	4-channel 30 dB higher power attenuator
ZT-234	1 - 3000	100	4U	High power switch / attenuator system

Featured Systems

Model Name	Frequency (MHz)	Output Channels	Power per Channel (W)	Description
HTOL-700-2700-1W	700 - 2700	80	1	HTOL signal source and distribution system
HTOL-2500-6000-1W	2500 - 6000	80	1	HTOL signal source and distribution system
HTOL-700-2700-3W	700 - 2700	80	3	HTOL signal source and distribution system

High-Power Amplifiers

Key Benefits

- Rack-mountable broadband amplifiers
- Saturated output powers up to 100W
- See p. 51 for custom amplifier configurations



Featured Systems

Model Name	Frequency (MHz)	Gain (dB)	PSAT (W)	Rack Height
HPA-25W-272+	20 - 2700	50	25	2U
HPA-50W-63+	700 - 6000	56	50	3U
HPA-272+	700 - 2700	48	100	3U
HPA-100W-63+	2500 - 6000	58	100	3U

Use Case: 80-Channel HTOL Test System

HTOL (high temperature operating life) is a test methodology intended to stress a device over an extended period of time, allowing calculation of a device's long-term reliability. The test is applicable to a wide range of component manufacturing applications, IC manufacturers in particular, including amplifiers, filters and transceivers.

The concept requires an RF splitter system to distribute a test signal over a large number of DUT (device under test) channels in parallel so that a statistically significant calculation of reliability can be made. A high power signal source is also required, sufficient to drive each DUT at the appropriate level whilst also overcoming the inevitable signal losses, inherent in the distribution system.

Mini-Circuits can provide all the building blocks required for HTOL testing, including a ready-made integrated system supplied in a rack cabinet. The system pictured in the block diagram and image below is HTOL-700-2700-1W, a complete HTOL test setup capable of driving 80 parallel DUT at 1W each in the 700-2700 MHz band.

The component modules are:

- **SSG-6000RC** signal source
 - 25 to 6000 MHz CW signal generation with up to +14 dBm output
- **ZAPD-2-272+** power splitter
 - Wideband 2-way splitter, routing the signal source into 2 parallel paths
- 2 x **HPA-272+** high power amplifiers
 - Pair of 700 to 2700 MHz power amplifiers, each with 100 W saturated output power
- 2 x **ZT-10HPS-272+** high power splitters
 - Pair of 10-way splitters covering 700 to 2700 MHz with 100W input power rating
- 2 x **ZT-184** medium power splitter matrix
 - Each ZT-184 houses 10 x 4-way splitter/combiners covering 380 to 4600 MHz, with an input power rating of 30W

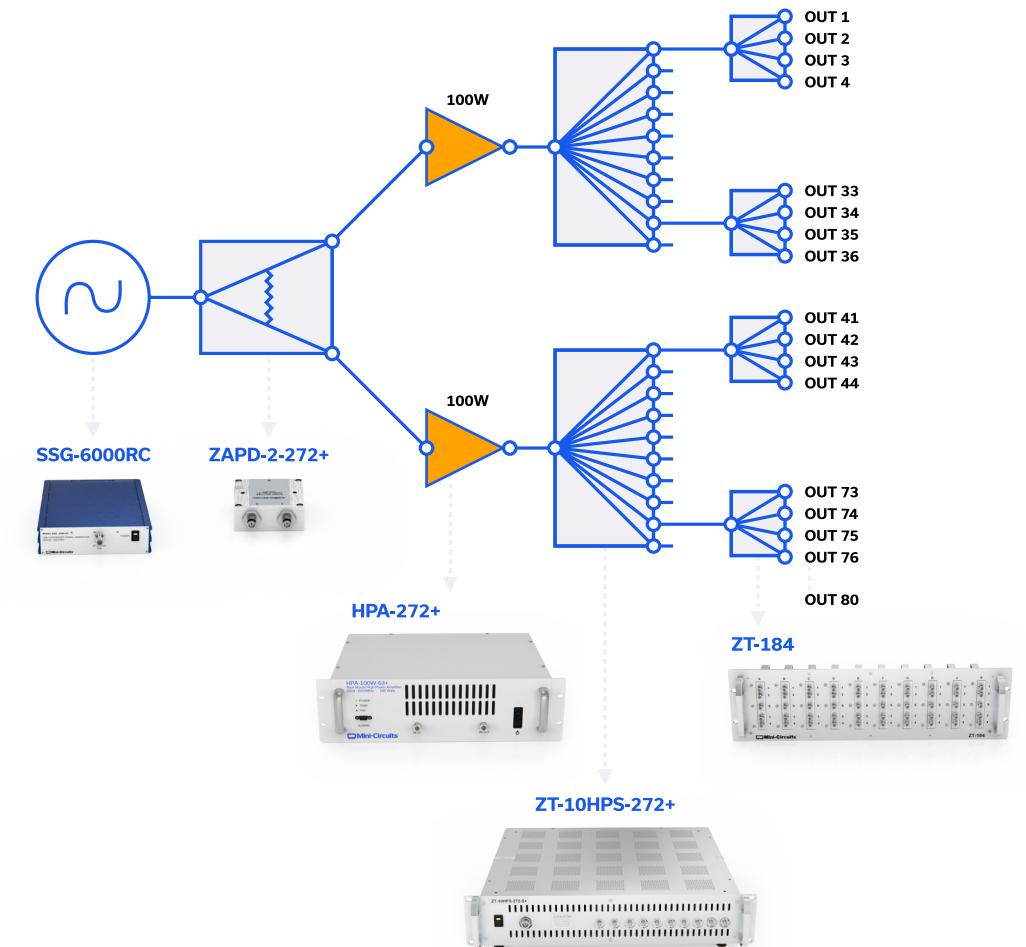

Integrated Amplifier Systems

Overview

Mini-Circuits' extensive selection of amplifiers in stock allows us to build integrated amplifier systems for specific test applications. These systems range in complexity from simple multi-channel amplifier racks to designs with additional functions such as gain control, filtering and more.

Key Benefits

- Wide selection of amplifier modules in stock
- Custom integration
- Rugged designs ideal for demanding lab use
- Fast turnaround
- See p. 48 for high-power rack mount amplifiers



Close-Up: ZT-228

4-Channel Wi-Fi Diplexing Amplifier



Mini-Circuits' ZT-228 is a 4-channel filtered amplifier for Wi-Fi applications. Each of the 4 inputs is split and independently amplified on separate paths for the low and high Wi-Fi bands (centered at 2.4-2.5 and 5.7-5.9 GHz, respectively), with 60 dB rejection of the opposite band. The system is housed in 1U rack-mount chassis with a built-in AC power supply.

RF Specifications (per channel):

Parameter	Value
Low Band	
Frequency	2.4-2.5 GHz
Gain	17 dB typ
P1dB	16 dBm typ
NF	6 dB typ
High Band Rejection	60 dB typ
High Band	
Frequency	5.7-5.9 GHz
Gain	17 dB typ
P1dB	17 dBm typ
NF	4 dB typ
Low Band Rejection	60 dB typ
Input Power	10 dBm max
Pass Band Return Loss	12 dB typ

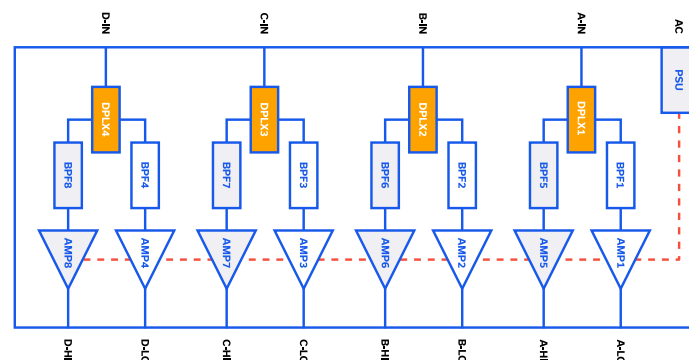

Close-Up: ZT-270

4-Channel Variable Gain Amplifier

Mini-Circuits' ZT-270 is a UHF band variable gain amplifier (VGA) with 4 independently controlled channels. Each channel provides up to 2W output power with 30 dB gain control at 0.25 dB steps. Four separate ON/OFF power switches on the front panel allow any channel to be quickly and safely isolated by terminating the input signal into an internal load. The gain can be controlled via USB or Ethernet (supporting both HTTP and Telnet network protocols).

The system is housed in a compact 19-inch rack chassis (3U height) with SMA connectors, 4 x RF inputs on the front panel and 4 x RF outputs on the rear panel.

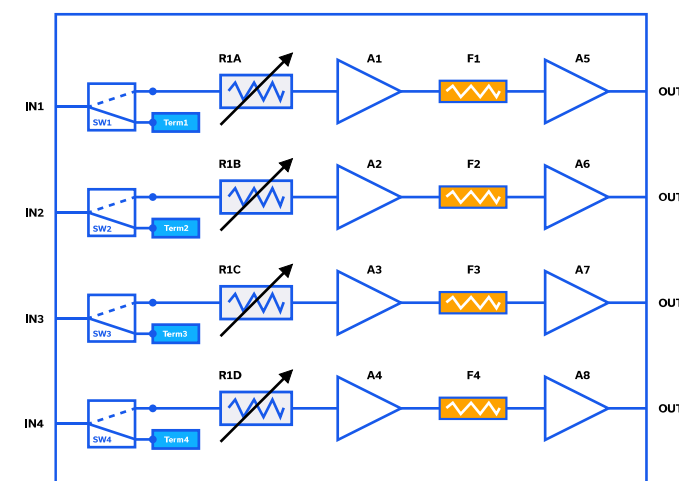

Specifications (Each Amplifier, 25 ° C)

Parameter	Conditions	Min	Typ	Max	Unit
Frequency	-	10	-	300	MHz
Small Signal Gain	@ 0 dB attenuation	50	52	-	dB
Input Return Loss	-	-	18	-	dB
Output Return Loss	-	-	15	-	dB
Attenuation Range	-	0	-	30	dB
Step Size	-	-	0.25	-	dB
Input Power	@ 0 dB Attenuation Setting	-	-	-20	dB

Approximate Attenuation Settings for 2W Output

Input Power (dBm)	RCDAT Setting (dB)	Output Power (dBm)
4	24	33
0	20	33
3	17	33

Close-Up: ZT-285

12-Channel Amplifier System

ZT-285 is a 12-channel amplifier system, supplied in a 2U height, 19" rack-mount chassis with a single AC mains power supply connection and SMA input / output connectors on the front and rear panels. Each independent amplifier channel operates over 500-2500 MHz, ideal for L-band satellite communications and telecommunications applications, achieving high gain and high directivity across the band.

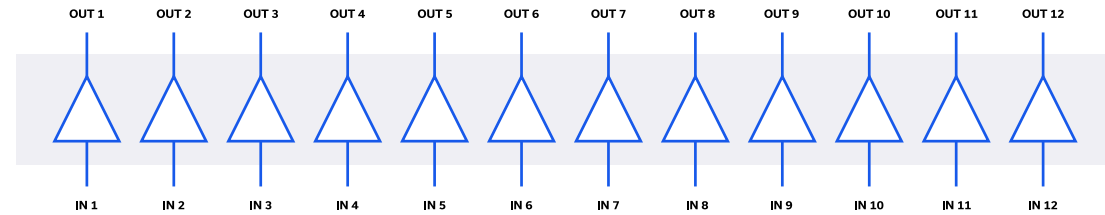

Specifications (Each Amplifier, 25 ° C)

Gain over Frequency in GHz (dB)					Maximum Power (dBm) Output (1 dB Comp.)			Dynamic Range		VSWR (:1) 1.5-2. GHz		Active Directivity (dB)	
0.5	1.0	1.5	2.0	2.5	Min @ 2 GHz	FL	FU	NF (dB) 1 GHz	IP3 (dBm)		In	Out	
												-	
										1 GHz	2 GHz		
37	41.5	41	39	37	33	19	17	2.9	24	26	1.3	1.5	24

“ Been working with Mini-Circuits for over 12 years at this company and my previous one. The basic standard has always been quick, timely response to quote requests, rarely late on deliveries, and no quality issues at all. A true pleasure to deal with, and I wish more of my suppliers would work and perform as well as Mini-Circuits does.

— **Mark P.**

BAE SYSTEMS

Measurement Solutions

Overview

- 2-Port Vector Network Analyzer
- Power Meters
- Signal Generators

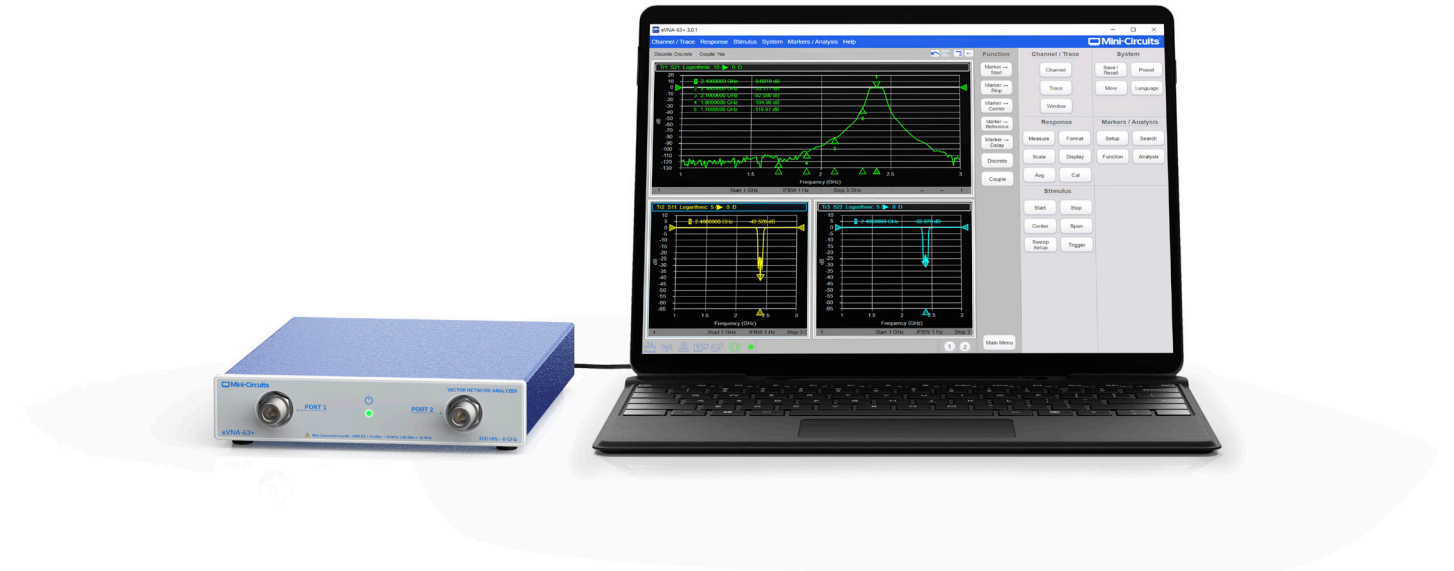

Introducing the eVNA

Overview

The eVNA-63+ is a high-quality, affordable USB- and Ethernet-controlled 2-port vector network analyzer capable of performing highly accurate 2-port, 2-path S-parameter measurements from 300 kHz to 6 GHz. The eVNA provides industry leading value with outstanding dynamic range, output power range and trace noise performance along with multiple features unavailable on competitive products on the market for the price. It comes with Mini-Circuits' full-featured GUI program and API for programming. Mechanical and Electronic (eMCal) kits are also available.

Key Benefits

- 2-port 2-path S-parameters
- Built-in bias tee accessible on both ports
- API for Windows® and LabView®
- SCPI Command Interface
- Touchstone file import and export
- Compact size, 10 x 8 x 1.75"
- Time domain & gating
- Port extension de-embedding
- Yearly factory calibration
- 3-year warranty
- Light weight, 4.5 kg / 9.92 lbs

Dynamic Range

>120 dB

Trace Noise

<0.008 dBrms

Output Power

-50 to +7 dBm

Close-Up: eVNA-63+

Measurement & Display

- Full 2-port S-parameters (S11, S21, S12, S22) as well as absolute receiver quantities from reference and reflection receivers
- Up to 16 independent measurement channels
- Up to 16 display traces per measurement channel
- Set up to 9 markers per trace
- Display traces can be stored to memory which can be displayed or used in trace math operations (Data + Mem, Data - Mem, Data * Mem, Data / Mem)
- Display traces can be viewed in several formats: Log Mag, Phase (Deg), Phase (Rad), Group Delay, Lin Mag, SWR, Real, Imaginary, Unwrapped Phase, Positive Phase, Smith, Polar

Analysis and Marker

- Marker search: Max, Min, Peak, Target
- Marker function: set sweep and scaling settings using markers as reference
- Limit and bandwidth tests: integrated pass/fail testing for min/max, ripple, and bandwidth limits
- Time domain transform: low pass and band pass time domain transform
- Time domain gating: fixture de-embedding using time-domain techniques

Sweep Stimulus

- Sweep type: Lin Freq, Log Freq, Power, Segmented
- Sweep mode: normal or fast
- Number of points: up to 20,001
- IF bandwidth: 1 Hz to 500 kHz
- Port power setting: -50 to +7 dBm
- Power slope setting: -2 to +2 dB/GHz

Data Export

- S-parameter file
- CSV trace data
- Screenshot

Calibration and Correction

- Response
- Enhanced response
- 1-port SOL
- 2-port SOLT
- Electronic calibration
- Port extension
- Power calibration

Calibration Kits & Accessories

Mechanical Calibration Kit

- Short, Open, Load & Thru (SOLT)
- N-type & SMA
- Works with VNA from any vendor

Electronic Calibration Kit (eMCal)

- Easy connection to eVNA + USB connection to PC
- Supports M/F SMA & M/F N-Type
- Works only with eVNA from Mini-Circuits

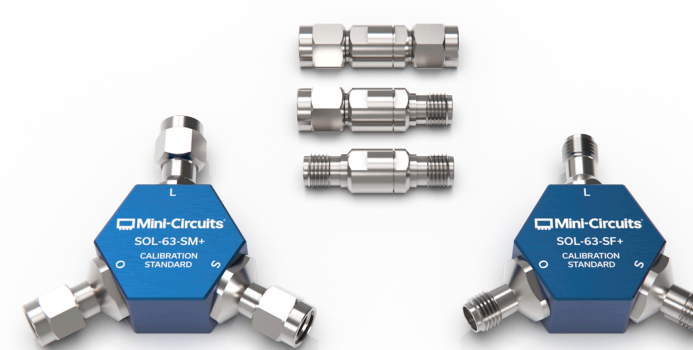

Figure 1: SMA KSOLT-63-S+ kit, including SOL (f & m) and Thru (f\leftrightarrowf, f\leftrightarrowm, m\leftrightarrowm) standards

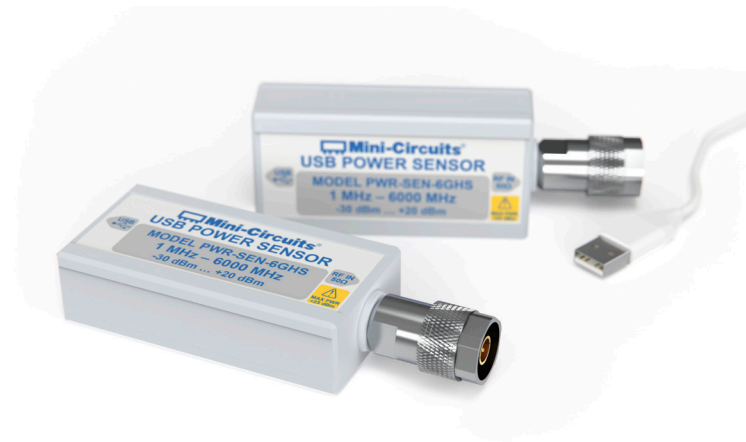

Figure 2: N-type KSOLT-63-N+ kit, including SOL (f & m) and Thru (f\leftrightarrowf, f\leftrightarrowm, m\leftrightarrowm) standards

Power Meters

Overview

USB and Ethernet controlled power sensors enable any PC to operate as a low-cost power meter. The included GUI software supports everything from simple one-off measurements to scheduled measurement tasks with CSV data reports. The sensors have automatic frequency and temperature compensation so no external calibration or set up is required, just plug in and start measuring!



Average Power Measurements for CW and Modulated Signals

Model Name	Signal Types	Zo	Frequency (MHz)		Dynamic Range (dBm)		Measurement Speed (ms)	Control
			Low	High	Low	High		
PWR-2.5GHS-75	CW	75	0.1	2500	-30	+20	30	USB
PWR-4GHS	CW	50	0.009	4000	-30	+20	30	USB
PWR-6GHS	CW	50	1	6000	-30	+20	30	USB
PWR-6LGHS	CW	50	50	6000	-45	+10	30	USB
PWR-8GHS	CW	50	1	8000	-30	+20	30	USB
PWR-8GHS-RC	CW	50	1	8000	-30	+20	30	USB & Ethernet
PWR-8FS	CW	50	1	8000	-30	+20	10	USB
PWR-6LRMS-RC	CW & Modulated	50	50	6000	-45	+10	30	USB & Ethernet
PWR-6RMS-RC	CW & Modulated	50	50	6000	-35	+20	30	USB & Ethernet

Measurement Accuracy vs. Competitor for LTE Signals

Mini-Circuits PWR-6LRMS-RC is a low-cost sensor suitable for measurement of modulated signals. A simple test was conducted to verify the measurement accuracy of PWR-6LRMS-RC against a higher cost competitive model from a well-established test equipment manufacturer. The test signal was configured as shown below using a Keysight N5182A signal source:

- 1C LTE 5 MHz
- 64QAM, 1 resource block, high channel, FDD
- Frequency: 2 GHz
- **PAR:** 9.7 dB
- **Power Out:** -33 to +2 dBm

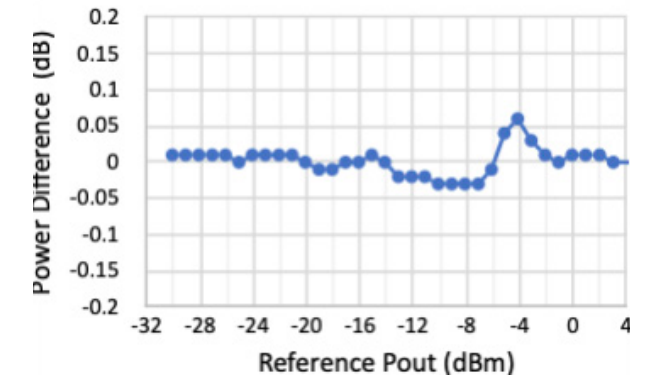

The test confirmed the accuracy of Mini-Circuits' PWR-6LRMS-RC to be within ± 0.06 dB of the reference measurement.

Power Meters Continued

Peak & Average Measurements for CW, Modulated & Pulsed Signals

- Increased dynamic range with faster sampling time
- Allows plotting of pulse profile with time
- Peak & average measurements with statistical analysis (duty cycle, rise / fall time, pulse width)

Catalog Models								
Model Name	Signal Types	Frequency (MHz)		Dynamic Range (dBm)		Sample Rate (/sec)	Measurement Bandwidth	Control
		Low	High	Low	High			
PWR-8P-RC	CW, Modulated & Pulsed	10	8000	-60	+20	0.5 million	100 kHz	USB & Ethernet
PWR-8PW-RC	CW, Modulated & Pulsed	10	8000	-60	+20	20 million	10 MHz	USB & Ethernet
PWR-40P-RC	CW, Modulated & Pulsed	10	40000	-24	+20	20 million	10 MHz	USB & Ethernet

Frequency & Average Power Measurements for CW Signals

- Measure frequency and power from a single low-cost tool
- Standalone measurements using the integrated display



Catalog Models								
Model Name	Signal Types	Impedance	Frequency (MHz)		Dynamic Range (dBm)		Power Measurement Speed (ms)	Control
			Low	High	Low	High		
FCPM-6000RC	CW	50	1	6000	-30	+20	30	USB & Ethernet

Signal Generators

Mini-Circuits' SSG series offers reliable and repeatable signal sources with full automation via Ethernet or USB, available at a fraction of the cost of traditional benchtop signal sources. Other high-end signal generators on the market often come with advanced features many customers don't need. Our generators provide a versatile, high-performance signal source at a fraction of the cost.

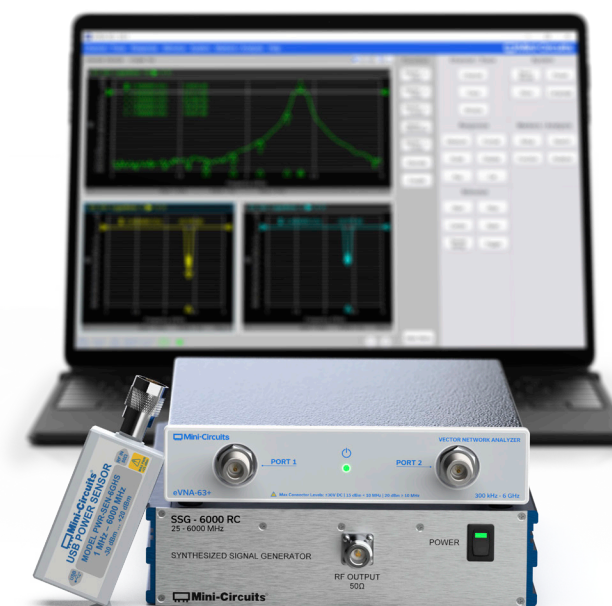

Common Applications

- LTE / 5G / Wi-Fi (2.4-7.2 GHz) testing
- Dynamic Frequency Selection (DFS) simulation
- Lab and field test equipment
- High volume production testing / ATE

Catalog Models						
Model Name	Frequency			Output Power		Control
	Low (MHz)	High (MHz)	Resolution (Hz)	Low (dBm)	High (dBm)	
SSG-6000RC	25	6,000	3-6	-65	+14	USB & Ethernet
SSG-6001RC	1	6,000	3-6	-70	+15	USB & Ethernet
SSG-15G-RC	10	15,000	0.1	-50	+16	USB & Ethernet

Close-Up: SSG-15G-RC

Ultra-Wideband Synthesized Signal Generator

- 10 MHz to 15 GHz with 0.1 Hz resolution
- CW and pulsed output signals
- 60 dB typical output dynamic range
- Configure automated sweep, hop and pulse sequences
- USB & Ethernet control



Panel-Mounted Structures

Overview

Mini-Circuits' panel-mounted structures provide clean, organized management of cable runs and connections in complex, high-volume test setups. Multiple connector adapters, power splitters, directional couplers and other essential RF components and test accessories can be integrated efficiently within the test system. Custom configurations are available upon request.

Key Benefits

- Organized management of cable runs in busy test setups
- Choose from adapters, splitters couplers and other coaxial components
- Wide variety of standard configurations
- Custom configurations with fast turnaround

Types/families

- Patch panels
- Passive component panels

Patch Panels

Starting from \$795

Key Benefits

- Tidy cable connections with patch panels directly on the rack
- Convert between connector types
- Use as "connector savers" to reduce wear on high-cost test equipment connectors

Featured Configurations

ZT-96KFFL-KF50+ | DC to 40 GHz

- 96 x connector adapters
- 2.92 mm female to 2.92 mm female
- 19" width, 5U height

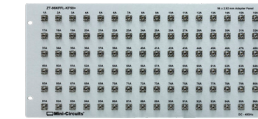

ZT-182 | DC to 11 GHz

- 48 x connector adapters
- N-type female to N-type female
- 19" width, 4U height

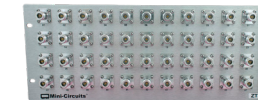

ZT-183 | DC to 18 GHz

- 48 x connector adapters
- N-type female to SMA female
- 19" width, 4U height

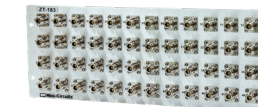

ZT-240 | DC to 6 GHz

- 24 x connector adapters
- N-type female to N-type female
- 19" width, 4U height
- Extended mounting brackets

ZT-240BK | DC to 6 GHz

- 24 x connector adapters
- N-type female to N-type female
- 19" width, 4U height
- Black anodized panel

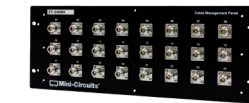

ZT-312 | DC to 18 GHz

- 12 x connector adapters
- N-type female to SMA female
- 19" width, 1U height



ZT-314D | DC to 18 GHz

- 80 x connector adapters
- SMA female to SMA female
- 19" width, 2U height

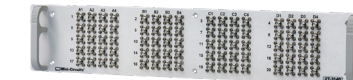

Passive Component Panels

Starting from \$1,195

Choose from 1000+ passive components in stock:

- Power splitter / combiners
- Directional couplers
- High power fixed attenuators
- Simplify test setups by integrating accessories into the rack

Featured Configurations

ZT-230 | 1 to 500 MHz

- 8 x 10 dB directional couplers
- 19" width, 2U height
- SMA female connectors



ZT-256 | DC to 18 GHz

- 12 x 2-way resistive splitter/combiners
- 19" width, 2U height
- SMA female connectors

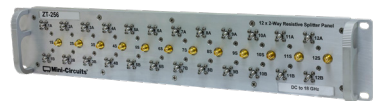

ZT-333 | 100 to 900 MHz

- 4 x 2-way splitter/combiners
- 19" width, 1U height
- SMA female connectors



ZT-245 | 300 to 1000 MHz

- 1 x 8-way splitter/combiner
- 19" width, 1U height
- SMA female connectors



ZT-277 | 600 to 6000 MHz

- 3 x 4-way splitter/combiners
- 19" width, 1U height
- SMA female connectors



ZT-257 | 600 to 6000 MHz

- 4 x 4-way splitter/combiners
- 19" width, 1U height
- SMA female connectors



ZT-184 | 500 to 6000 MHz

- 10 x 4-way splitter/combiners
- 19" width, 3U height
- SMA female connectors

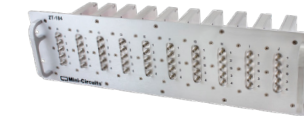

ZT-304 | 500 to 6000 MHz

- 8 x 2-way splitter/combiners
- 19" width, 1U height
- SMA female connectors

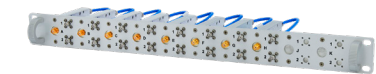

ZT-255 | 500 to 8500 MHz

- 8 x 2-way splitter/combiners
- 19" width, 2U height (black anodized panel)
- SMA female connectors

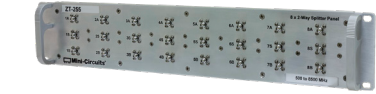

ZT-229B | 0.5 to 600 GHz

- 16 x 2-way splitter/combiners
- 19" width, 2U height
- SMA female connectors

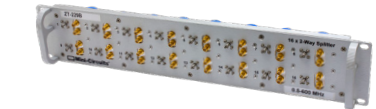

ZT-222 | 350 to 6000 GHz

- 20 x 2-way splitter/combiners
- 19" width, 4U height
- N-type female connectors



Signal Distribution

Overview

For test systems requiring distribution of signal to many DUTs, Mini-Circuits' signal distribution systems combine splitter/combiners and directional couplers to expand test signal into multiple channels. Amplifiers can also be incorporated to minimize path loss and manage signal power from input to output.

Key Benefits

- Wide selection of splitter/combiners and directional couplers in stock
- Bandwidths up to 65 GHz
- RF input power up to 250W
- Rack-mounted, panel-mounted or benchtop structures

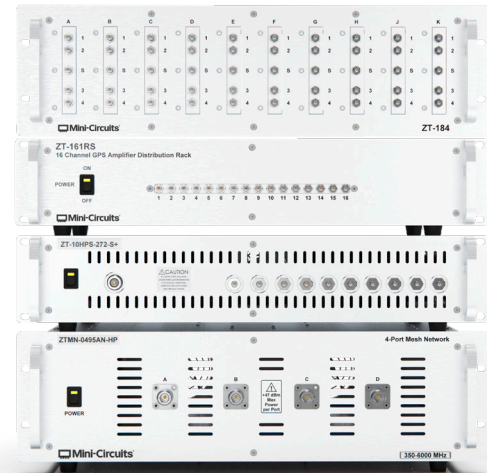

Close-Up: ZT-161RS

L-Band Active Splitter Module

- 16-way active splitter
- Ideal for GNSS signal distribution applications
- 20+ dB gain per channel



Specifications (25 °C)

Parameter	Conditions	Min	Typ	Max	Unit
Frequency	-	1200	-	1600	MHz
Gain	Per Channel	20	-	-	dB
VSWR	-	-	1.4	-	dB
Isolation	Between Outputs	-	25	-	dB
Input Power	-	-	-	-25	dBm

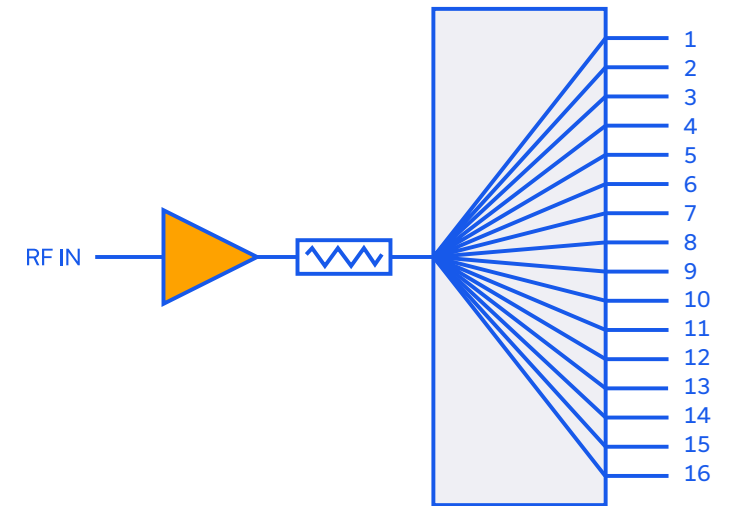

Standard Configurations

Model Name	Description	Frequency Range (MHz)	# of Inputs	# of Outputs	Connector Type
ZT-104	16-Way Active Splitter - 10 MHz Reference Distribution Module	10	1	16	BNC
ZT-201	20x2-Way Splitter Array	350 to 6000	20	40	N-type
ZT-207	6x 2-Way Splitter Array	350 to 6000	6	12	N-type to SMA
ZT-208	4x 4-Way Splitter Array	380 to 4600	4	16	N-type
ZT-246	12 x 2-Way Splitter Array	350 to 6000	12	24	SMA
ZT-161RS	16-Way Active L-Band Splitter	1200 to 1600	1	16	SMA

Custom Systems

Overview

Our experience in the test space has evolved according to your needs. The diversity of customer requirements for highly customized test solutions has led us to build our business around principles of flexibility, reliability, economy and speed. Our wealth and variety of components in stock allows along with our in-house design, manufacturing and applications expertise allows us to develop a wide range of custom equipment for your special requirements at highly competitive cost and with fast turnaround.

Key Benefits

- Designed and built to your unique test requirements
- All systems fully characterized during production
- On-site integration available when needed
- Full GUI and API for programming with your native test software



Lab Accessories

Mini-Circuits' extensive selection of thousands of stocked catalog components offers everything you need to supply your RF test lab. If you're considering one of our integrated systems for your test setup, be sure to check out our connectorized components for all your needs on the bench.



Connector Types:

BNC, N-Type, SMA, SMA reverse polarity, SMA quick connect, SMP, 3.5 mm, 2.92 mm, rugged 2.92, 2.4 mm, rugged 2.4 mm, 1.85mm

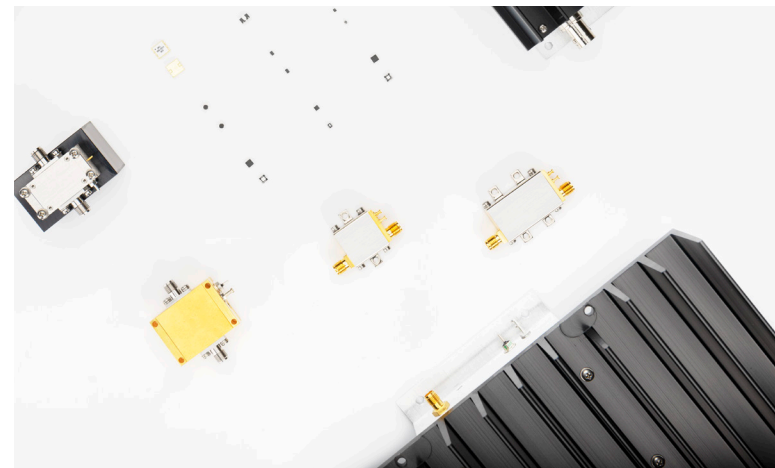

DC TO 67 GHZ

Adapters

Wide Variety of Connector Types

- All gender combinations
- Standard, right-angle, bulkhead and NMD mounting types
- Low loss and excellent VSWR
- Rugged construction

DC TO 43.5 GHZ

Amplifiers

250+ Connectorized Models

- High power amplifiers up to 100W
- Class A and Class AB linear amplifiers
- Low noise amplifiers, NF as low as 0.4 dB
- Ultra-wide bandwidths with flat gain
- Rugged designs with built-in protections

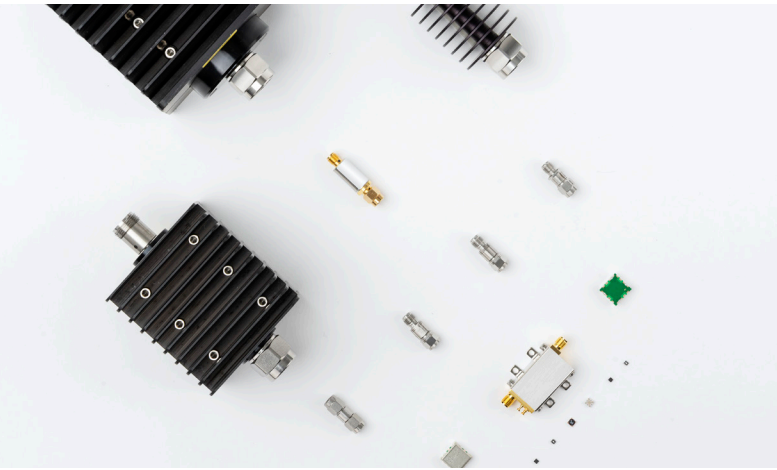

DC TO 65 GHZ

Attenuators

200+ Connectorized Models

- Precision fixed
- Digital step
- Voltage variable
- Input power up to 100W
- Attenuation from 0 to 50 dB

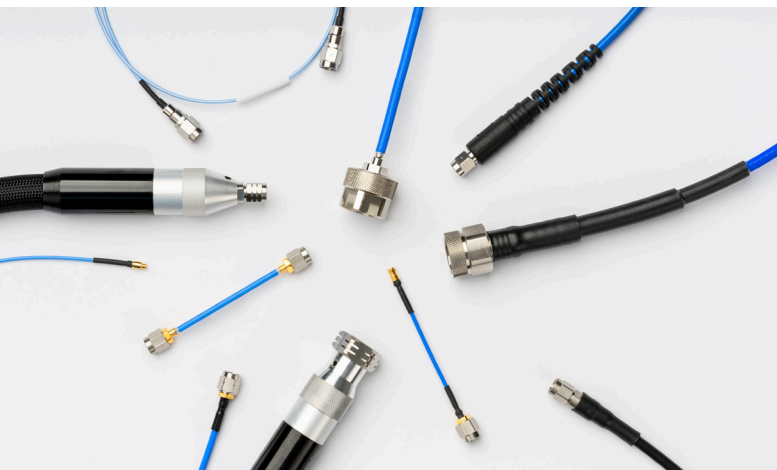

DC TO 67 GHZ

Coaxial Cables

375+ Models in Stock

- Precision test cables
- VNA cables
- Interconnect cables
- Custom assemblies available on request

Connector Types:

BNC, MMCX, N-Type, SMA, SMP, 3.5 mm, 2.92 mm, rugged 2.92, 2.4 mm, rugged 2.4 mm, 1.85mm



DC TO 65 GHZ

Couplers

190+ Connectorized Models

- Directional, bi-directional, dual-directional and RF tap
- Power handling up to 250W
- DC passing and DC blocking
- 50 and 75Ω designs

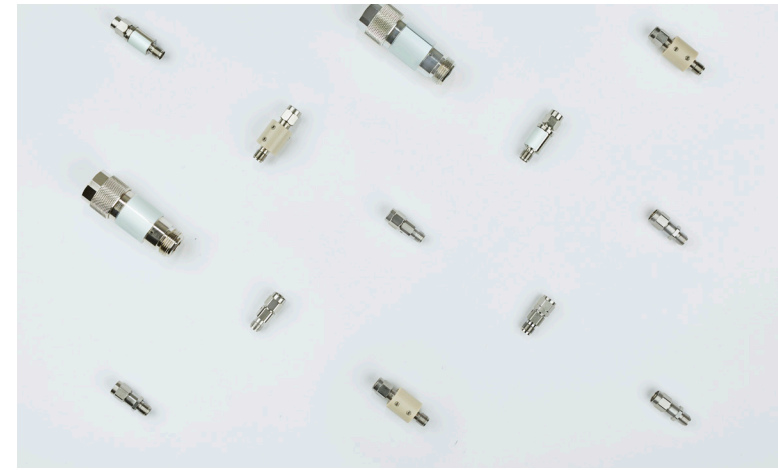

DC TO 65 GHZ

DC Blocks

Wideband, High-Voltage

- DC input up to 200V
- Low insertion loss
- Excellent return loss

Connector Types:

BNC, N-Type, SMA, 2.92mm, 2.4mm, 1.85mm

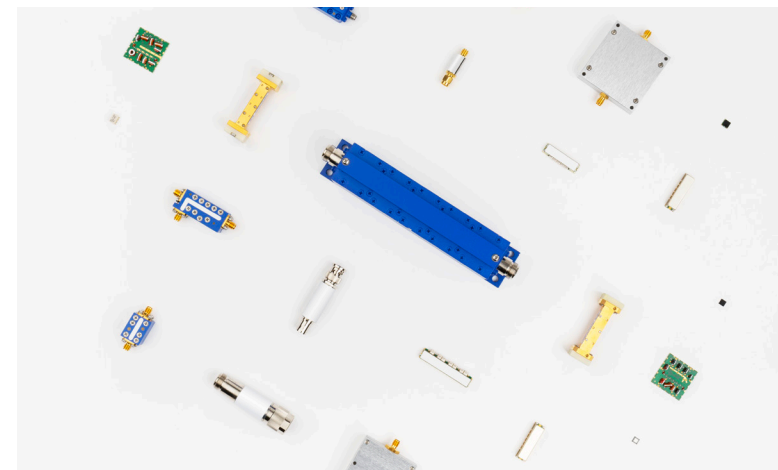

DC TO 87 GHZ

Filters

For Every Application

- 500+ connectorized models in stock
- Low pass, band pass, high pass, band stop, diplexers and triplexers
- Custom designs with fast turnaround

Technology for every need:

Cavity, ceramic resonator, lumped LC, LTCC, microstrip, suspended substrate, waveguide

METROLOGY-GRADE

Gauges

Optimize Performance

- Check connector interfaces for optimal performance before mating
- Avoid unreliable measurements due to misaligned or damaged connectors
- Available for SMA, BNC and N-Type connector types
- Easy calibration



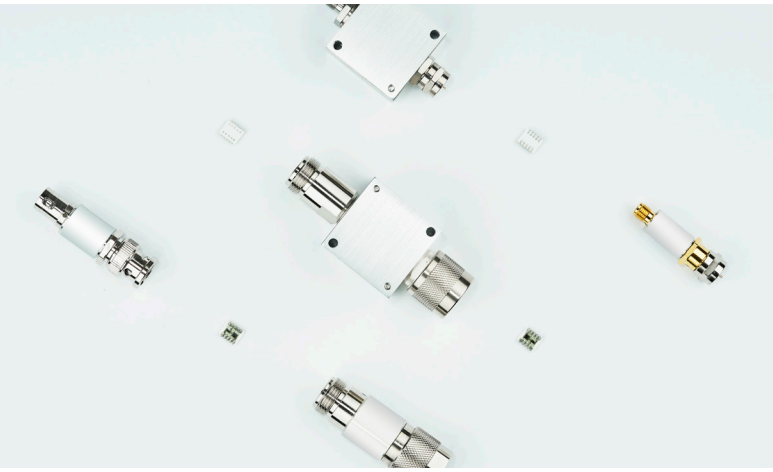

DC TO 3000 GHZ

Impedance Matching Pads

Seamless 50/75Ω Conversion

- Ideal for testing 75Ω devices
- Excellent VSWR (1.05 to 1.3)
- Flat attenuation vs. frequency
- BNC, SMA and N-Type connector options

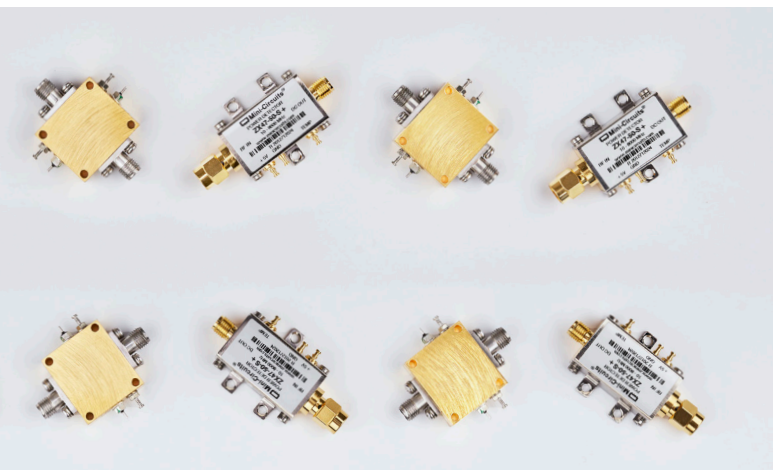

10 MHZ TO 40 GHZ

Power Detectors

Wide Bandwidth and Dynamic Range

- Input power ranges spanning -60 to +20 dBm
- Peak and RMS measurement types
- Linear-in-dB response
- Fast response time

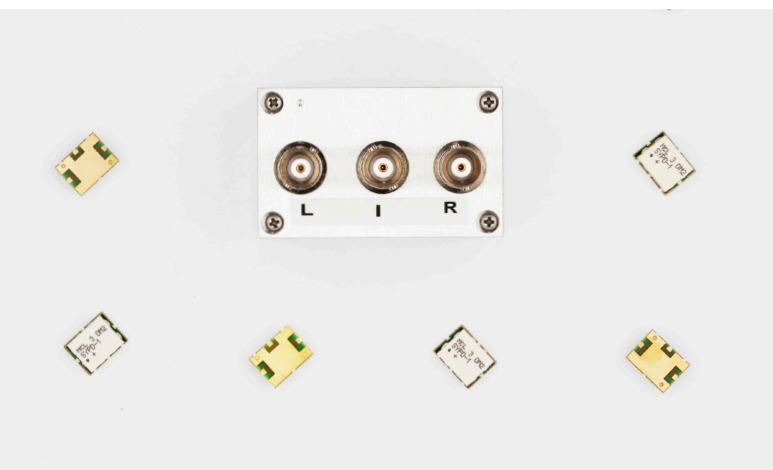

1 TO 650 MHZ

Phase Detectors

For Monitoring and Levelling Circuits

- High DC output vs. phase, up to 1V
- Low DC offset
- Coaxial and Surface Mount Models

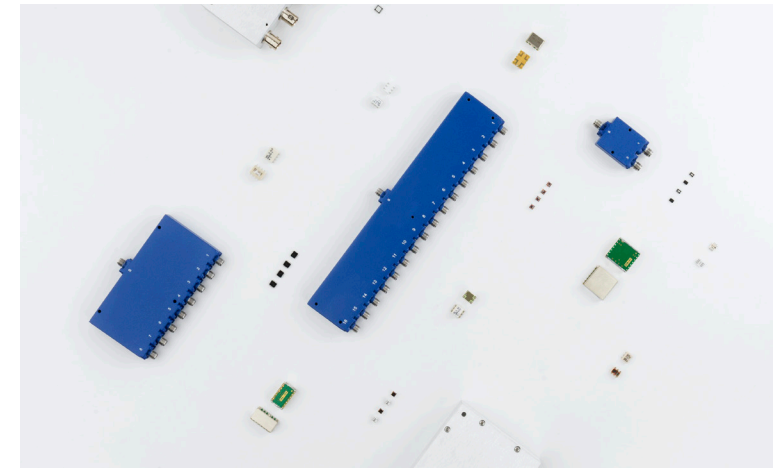

POWER SPLITTERS/COMBINERS

Power Splitters & Combiners

300+ Connectorized Models

- High DC output vs. phase, up to 1V
- Low DC offset
- Coaxial and Surface Mount Models

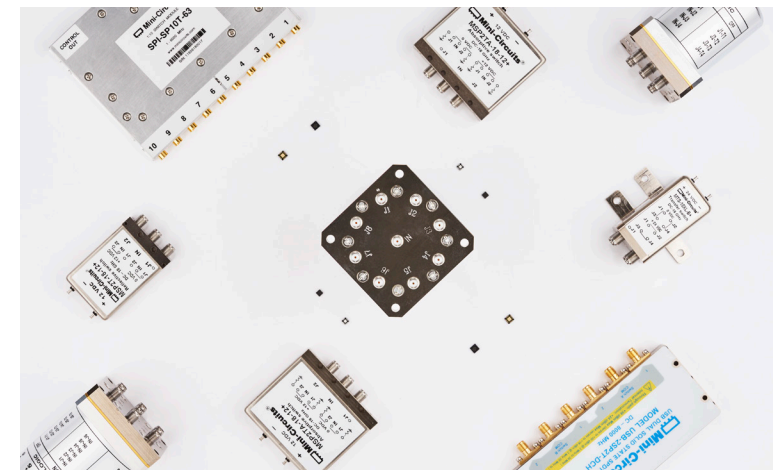

DC TO 50 GHZ

Switches

Ultra-Reliable

- Switch configurations from SPDT to SP16T
- Patented electromechanical switches capable of 10-million cycles without failure
- Solid-state switches with high isolation up to 110 dB

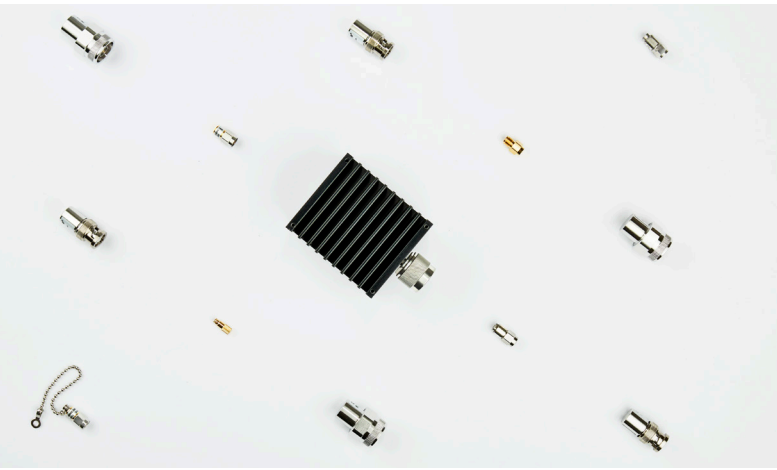

Connector Types:

DIN 1.0/2.3, BNC, TNC, SMB, SMA, SMP, N-Type, 2.92mm, 2.4mm, 1.85mm

DC TO 65 GHZ
Terminations

Up to 500W

- Excellent return loss
- 50 and 75Ω models
- Wide selection of connector types



PRECISION TOOLED

Wrenches

Simplify Connection and Disconnection

- Eases connections in tight spaces and crowded port configurations
- Prevents damage to connectors

Pocket-sized SMA wrenches ideal for crowded port configurations

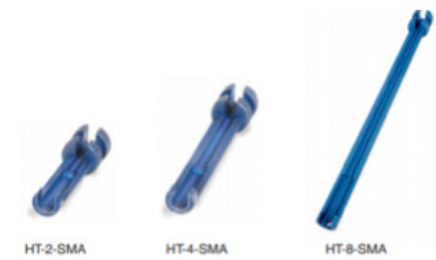

8-in-lbs calibrated break-over torque wrenches for SMA, 3.5 mm, 2.92 mm, 2.4 mm and 1.8 mm



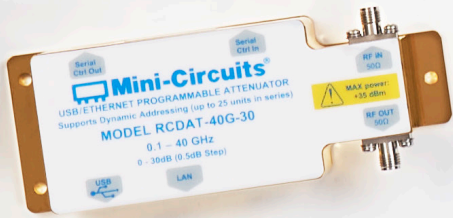
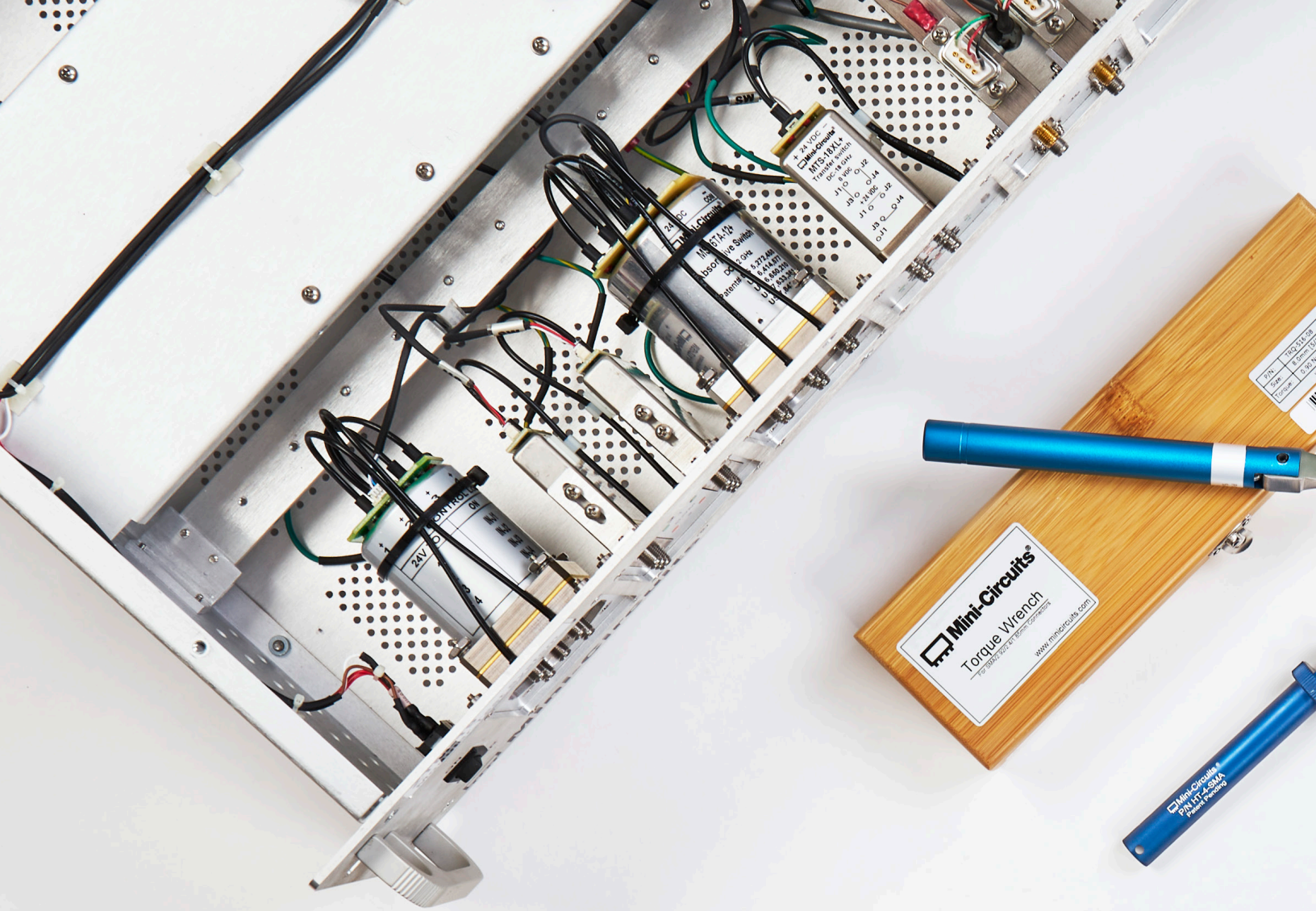

minicircuits.com

testsolutions@minicircuits.com

