

NEW!
Two & Three
Section Models

MMIC

REFLECTIONLESS FILTERS DICE

50Ω DC to 21 GHz

The Big Deal

- High Stopband rejection, up to 50 dB
- Patented design terminates stopband signals
- Pass band cut-off up to 11 GHz
- Stop band up to 26 GHz
- Excellent repeatability through IPD* process

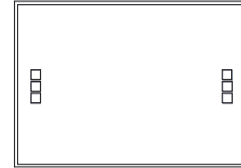

X-Series

Available in Low Pass
and High Pass designs

Product Overview

Mini-Circuits' **X-Series** of reflectionless filters now includes 2- and 3-section models, giving you ultra-high rejection in the stopband – up to 50 dB! Reflectionless filters employ a patented filter topology which absorbs and terminates stopband signals internally rather than reflecting them back to the source. This new capability enables unique applications for filter circuits beyond those suited to traditional approaches. Traditional filters are reflective in the stopband, sending signals back to the source at 100% power. These reflections interact with neighboring components and often result in intermodulation and other interferences. By eliminating stopband reflections, reflectionless filters can readily be paired with sensitive devices and used in applications that otherwise require circuits such as isolation amplifiers or attenuators.

Key Features	Advantages
Easy integration with sensitive reflective components, e.g. mixers, multipliers	Reflectionless filters absorb unwanted signals, preventing reflections back to the source. This reduces generation of additional unwanted signals without the need for extra components like attenuators, improving system dynamic range and saving board space.
High stopband rejection, up to 50 dB	Ideal for applications where suppression of strong spurious signals and intermodulation products is needed.
Enables stable integration of wideband amplifiers	Because reflectionless filters maintain good impedance in the stopband; they can be integrated with high gain, wideband amplifiers without the risk of creating instabilities in these out of band regions.
Cascadable	Reflectionless filters can be cascaded in multiple sections to provide sharper and higher attenuation, while also preventing any standing waves that could affect passband signals. Low & highpass filters can be cascaded to realize bandpass filters.
Excellent power handling in a tiny surface mount device up to 7W in passband	High power handling extends the usability of these filters to the transmit path for inter-stage filtering.
Excellent repeatability of RF performance	Through semiconductor IPD process, X-series filters are inherently repeatable for large volume production.
Excellent stability over temperature	With ± 0.3 dB variation over temperature ideal for use in wide temperature range applications without the need for additional temperature compensation.
Operating temperature up to 105°C	Suitable for operation close to high power components.

*IPD – Integrated Passive Device, is a GaAs semiconductor process



Reflectionless High Pass Filter Die

XHF-482M-D+

50Ω 4800 to 8000 MHz

Features

- Match to 50Ω in the stop band, eliminates undesired reflections
- Cascadable
- Excellent stopband rejection, 37 dB typ.
- Temperature stable, up to 85°C
- Protected by US Patents 8,392,495; 9,705,467, additional patent pending
- Protected by China Patent 201080014266.1
- Protected by Taiwan Patent I581494

Applications

- Mobile
- ISM Applications
- TV broadcasting
- UHF radar

General Description

Mini-Circuits' XHF-482M-D+ two-section reflectionless filter die employs a patented filter topology which absorbs and terminates stop band signals internally rather than reflecting them back to the source. This new capability enables unique applications for filter circuits beyond those suited to traditional approaches. Traditional filters are reflective in the stop band, sending signals back to the source at 100% of the power level. These reflections interact with neighboring components and often result in inter-modulation and other interferences. Reflectionless filters eliminate stop band reflections, allowing them to be paired with sensitive devices and used in applications that otherwise require circuits such as isolation amplifiers or attenuators.

Simplified Schematic and Pad description

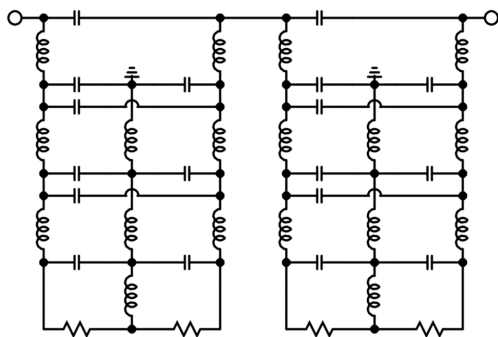

Pad#	Description
2	RF-IN
5	RF-OUT
1,3,4,6	Ground
Die bottom	Ground

Note: 1. Bond Pad material - Gold
2. Bottom of Die - Gold plated

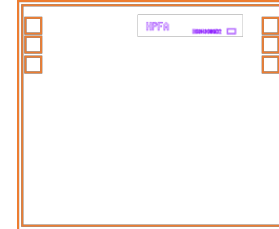

+RoHS Compliant

The +Suffix identifies RoHS Compliance. See our web site for RoHS Compliance methodologies and qualifications

Ordering Information: Refer to Last Page

Bonding Pad Position

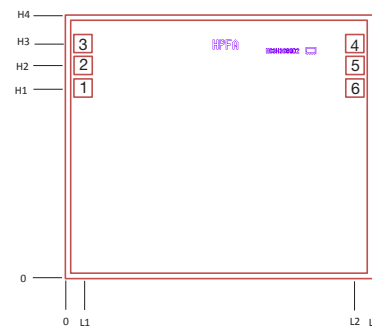

Dimensions in μm, Typical

L1	L2	L3	H1	H2	H3	H4	Thickness	Bond pad size
80	1320	1400	870	970	1070	1200	100	75 x 75

Electrical Specifications¹ at 25°C

Parameter	F#	Frequency (MHz)	Min.	Typ.	Max.	Unit
Stop Band	Rejection	DC-F1	—	37	—	dB
	Frequency Cut-off	F2	—	3.0	—	dB
	VSWR	DC-F1	—	1.2	—	:1
Pass Band	Insertion Loss	F3-F5	—	0.6	—	dB
	VSWR	F3-F5	—	1.2	—	:1

1. Measured on die using MPI Titan series 100 µm pitch as a probe

Absolute Maximum Ratings^{1,4}

Parameter	Ratings
Operating Temperature	-55°C to +105°C
RF Power Input, Passband (F3-F5) ²	1.3W at 25°C
RF Power Input, Stopband (DC-F3) ³	1.6W at 25°C

² Passband rating derates linearly to 0.6W at 105°C ambient

³ Stopband rating derates linearly to 0.8W at 105°C ambient

⁴ Permanent damage may occur if any of these limits are exceeded.

Specification Definition

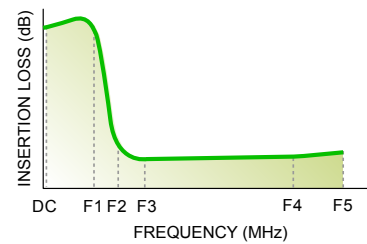

Typical Performance Data at 25°C¹

Frequency (MHz)	Insertion Loss (dB)	VSWR (:1)
10	61.3	1.24
100	51.7	1.25
500	29.9	1.25
1000	28.4	1.26
2000	34.2	1.04
3000	30.3	1.26
3500	37.3	1.11
4260	3.0	1.07
4500	2.1	1.10
4800	1.6	1.15
5500	1.0	1.19
6000	0.8	1.17
6500	0.7	1.14
7000	0.6	1.11
7500	0.6	1.08
8000	0.5	1.07
9000	0.5	1.08
10000	0.4	1.14
12000	0.5	1.27
14000	0.5	1.37
17800	0.6	1.41

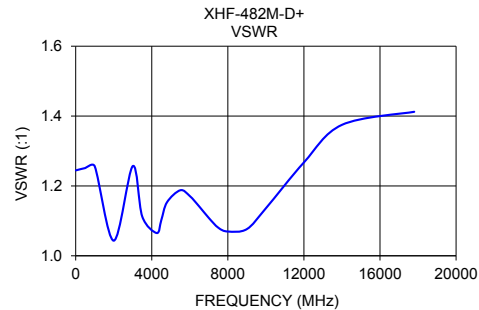
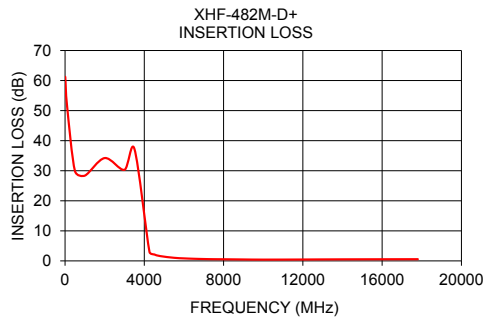

Assembly Diagram

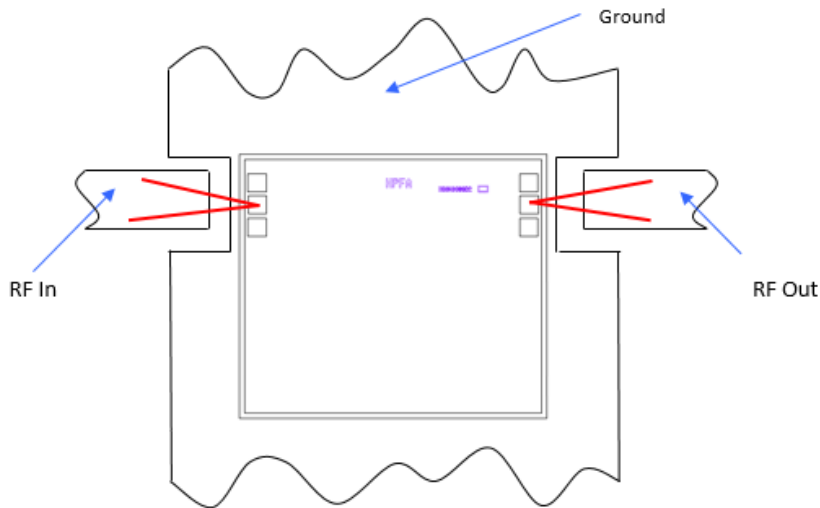

Note: Ground bond wires are optional.

Assembly and Handling Procedure

1. Storage
Dice should be stored in a dry nitrogen purged desiccators or equivalent.
2. ESD
MMIC Gallium Arsenide (GaAs) filter dice are susceptible to electrostatic and mechanical damage. Die are supplied in antistatic protected material, which should be opened in clean room conditions at an appropriately grounded anti-static workstation. Devices need careful handling using correctly designed collets, vacuum pickup tips or sharp antistatic tweezers to deter ESD damage to dice.
3. Die Attach
The die mounting surface must be clean and flat. Using conductive silver filled epoxy, recommended epoxies are DieMat DM6030Hk-PT/H579/H579 or Ablestik 84-1LMISR4. Apply sufficient epoxy to meet required epoxy bond line thickness, epoxy fillet height and epoxy coverage around total die periphery. Parts shall be cured in a nitrogen filled atmosphere per manufacturer's cure condition. It is recommended to use antistatic die pick up tools only.
4. Wire Bonding
Bond pad openings in the surface passivation above the bond pads are provided to allow wire bonding to the dice gold bond pads. Thermosonic bonding is used with minimized ultrasonic content. Bond force, time, ultrasonic power and temperature are all critical parameters. Suggested wire is pure gold, 1 mil diameter. Bonds must be made from the bond pads on the die to the package or substrate. All bond wires should be kept as short as low as reasonable to minimize performance degradation due to undesirable series inductance.

Additional Detailed Technical Information <i>additional information is available on our dash board.</i>	
Performance Data	Data Table
	Swept Graphs
	S-Parameter (S2P Files) Data Set with and without port extension(.zip file)
Case Style	Die
Die Ordering and packaging information	Quantity, Package Model No.
	Small, Gel - Pak: 5,10,50,100 KGD* XHF-482M-DG+ Medium†, Partial wafer: KGD*<1050 XHF-482M-DP+
	†Available upon request contact sales representative
	Refer to AN-60-067
Environmental Ratings	ENV-80

*Known Good Dice ("KGD") means that the dice are taken from PCM good wafer and visually inspected in question have been subjected to Mini-Circuits while this is not definitive, it does help to provide a higher degree of confidence that dice are capable of meeting typical RF electrical parameters specified by Mini-Circuits.

ESD Rating**

Human Body Model (HBM): Class 2(Pass 2000V) in accordance with ANSI/ESD STM 5.1 - 2001

** Tested in industry standard MCLP 3x3mm 12 lead package.

Additional Notes

- A. Performance and quality attributes and conditions not expressly stated in this specification document are intended to be excluded and do not form a part of this specification document.
- B. Electrical specifications and performance data contained in this specification document are based on Mini-Circuit's applicable established test performance criteria and measurement instructions.
- C. The parts covered by this specification document are subject to Mini-Circuits standard limited warranty and terms and conditions (collectively, "Standard Terms"); Purchasers of this part are entitled to the rights and benefits contained therein. For a full statement of the Standard Terms and the exclusive rights and remedies thereunder, please visit Mini-Circuits' website at www.minicircuits.com/MCLStore/terms.jsp
- D. Mini-Circuits does not warrant the accuracy or completeness of the information, text, graphics and other items contained within this document and same are provided as an accommodation and on an "As is" basis, with all faults.
- E. Purchasers of this part are solely responsible for proper storing, handling, assembly and processing of Known Good Dice (including, without limitation, proper ESD preventative measures, die preparation, die attach, wire bonding and related assembly and test activities), and Mini-Circuits assumes no responsibility therefor or for environmental effects on Known Good Dice.
- F. Mini-Circuits and the Mini-Circuits logo are registered trademarks of Scientific Components Corporation d/b/a Mini-Circuits. All other third-party trademarks are the property of their respective owners. A reference to any third-party trademark does not constitute or imply any endorsement, affiliation, sponsorship, or recommendation by any such third-party of Mini-Circuits or its products.