

MMIC

REFLECTIONLESS FILTER DICE

50Ω DC to 21 GHz

The Big Deal

- Patented design eliminates in band spurs
- Pass band cut-off up to 21 GHz
- Stop band up to 35 GHz
- Excellent repeatability through IPD* process
- Unpackaged Die Form

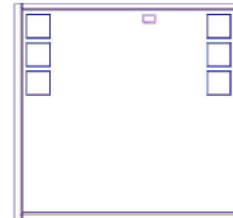

X-Series

Available in Low Pass, High Pass and Band Pass designs

Product Overview

Mini-Circuits' X-Series reflectionless filters employ a novel filter topology which absorbs and terminates stop band signals internally rather than reflecting them back to the source. This new capability enables unique applications for filter circuits beyond those suited to traditional approaches. Traditional filters are reflective in the stop band, sending signals back to the source at 100% of the power level which interact with neighboring components and often result in intermodulation and other interferences. Reflectionless filters eliminate stop band reflections, allowing them to be paired with sensitive devices and used in applications that otherwise require circuits such as isolators, isolation amplifiers or attenuators.

Key Features

Easy integration with sensitive reflective components, e.g. mixers, multipliers

Enables stable integration of wideband amplifiers

Cascadable

Excellent power handling in a tiny surface mount device

Excellent repeatability of RF performance

Excellent stability over temperature

Operating Temperature up to 105°C

Unpackaged Die form

Advantages

Reflectionless filters absorb unwanted signals, preventing reflections back to the source. This reduces generation of additional unwanted signals without the need for extra components like attenuators, improving system dynamic range and saving board space.

Because reflectionless filters maintain good impedance in the stop band; they can be integrated with high gain, wideband amplifiers without the risk of creating instabilities in these out of band regions.

Reflectionless filters can be cascaded in multiple sections to provide sharper and higher attenuation, while also preventing any standing waves that could affect pass band signals.

High power handling extends the usability of these filters to the transmit path for inter-stage filtering.

Through semiconductor IPD process, X-series filters are inherently repeatable for large volume production.

With ± 0.3 dB variation over temperature ideal for use in wide temperature range applications without the need for additional temperature compensation.

Suitable for operation close to high power components

Enables direct integration into customer hybrids

*IPD – Integrated Passive Device, is a GaAs semiconductor process



Reflectionless Low Pass Filter Die

XLF-63-D+

50Ω DC to 6000 MHz

Features

- Match to 50Ω in the stop band, eliminates undesired reflections
- Cascadable
- Excellent Power handling
- Protected by US Patent No. 8,392,495

Applications

- Harmonics Rejection
- Satellite
- Radar
- Military & Space

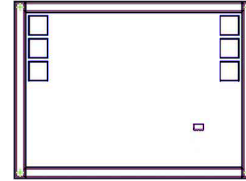

+RoHS Compliant

The +Suffix identifies RoHS Compliance. See our web site for RoHS Compliance methodologies and qualifications

Ordering Information: Refer to Last Page

General Description

Mini-Circuits' XLF-63-D+ reflectionless filter die employs a novel filter topology which absorbs and terminates stop band signals internally rather than reflecting them back to the source. This new capability enables unique applications for filter circuits beyond those suited to traditional approaches. Traditional filters are reflective in the stop band, sending signals back to the source at 100% of the power level. These reflections interact with neighboring components and often result in inter-modulation and other interferences. Reflectionless filters eliminate stop band reflections, allowing them to be paired with sensitive devices and used in applications that otherwise require circuits such as isolation amplifiers or attenuators.

Simplified Schematic

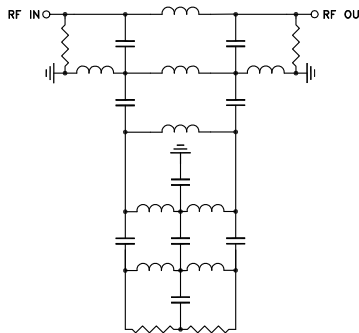

Pad	Description
RF-IN	RF Input Pad
RF-OUT	RF Output Pad
Ground	Ground Bonding Pad

Electrical Specifications¹ at 25°C

Parameter		F#	Frequency (MHz)	Min.	Typ.	Max.	Unit
Pass Band	Insertion Loss	DC - F1	DC-6000		1.3		dB
	Frequency Cut-off	F2	8100		3.0		dB
	VSWR	DC - F1	DC-6000		1.3		:1
Stop Band	Rejection	F3 - F5	9600 - 17800		15		dB
	VSWR	F3 - F5	9600 - 17800		1.5		:1

¹ Measured on Mini-Circuits Characterization test board. Die packaged in 3mm x 3mm, 12-lead MCLP package and soldered on TB-844-63+

Absolute Maximum Ratings^{1,4}

Parameter	Ratings
Operating Temperature	-55°C to +105°C
RF Power Input, Passband (DC-F1) ²	2W at 25°C
RF Power Input, Stopband (F2-F5) ³	150mW at 25°C

² Passband rating derates linearly to 1W at 105°C ambient

³ Stopband rating derates linearly to 75mW at 105°C ambient

⁴ Permanent damage may occur if any of these limits are exceeded.

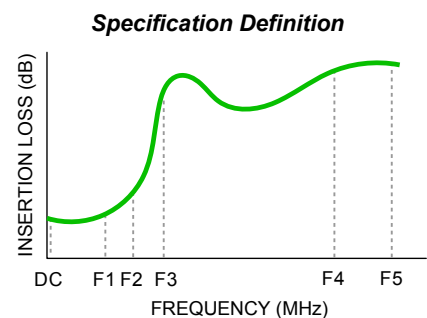

Typical Performance Data at 25°C¹

Frequency (MHz)	Insertion Loss (dB)	VSWR (:1)
10	0.44	1.03
50	0.41	1.01
100	0.41	1.02
200	0.41	1.04
400	0.43	1.09
600	0.46	1.14
1000	0.52	1.22
1500	0.60	1.29
2000	0.66	1.32
3000	0.76	1.31
4000	0.87	1.32
6000	1.28	1.41
8100	3.06	1.30
9600	16.34	1.07
10500	24.58	1.66
12000	18.46	1.76
14000	19.57	1.32
16000	22.78	1.49
17000	16.37	1.49
17800	14.04	1.81

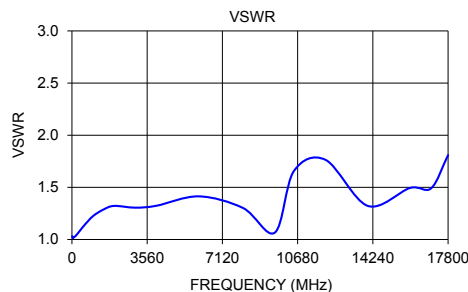

Die Layout

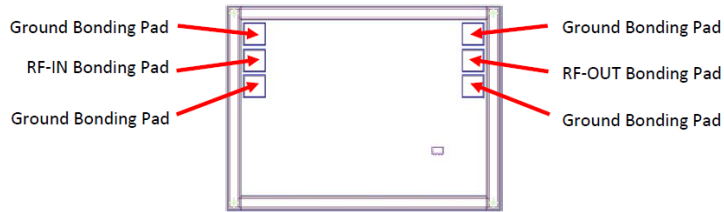

Fig 1. Die Layout

Bonding Pad Position
(Dimensions in μm , Typical)

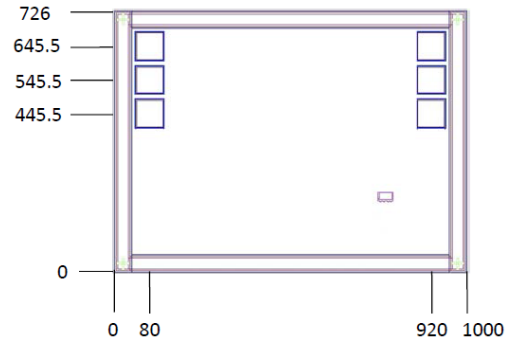

Fig 2. Bonding Pad Positions

Critical Dimensions

Parameter	Values
Die Thickness, μm	100
Die Width, μm	1000
Die Length, μm	726
Bond Pad Size (Ground pad), μm	75 x 75

Assembly and Handling Procedure

1. Storage
Dice should be stored in a dry nitrogen purged desiccators or equivalent.
2. ESD
MMIC Gallium Arsenide (GaAs) filter dice are susceptible to electrostatic and mechanical damage. Die are supplied in antistatic protected material, which should be opened in clean room conditions at an appropriately grounded anti-static workstation. Devices need careful handling using correctly designed collets, vacuum pickup tips or sharp antistatic tweezers to deter ESD damage to dice.
3. Die Attach
The die mounting surface must be clean and flat. Using conductive silver filled epoxy, recommended epoxies are DieMat DM6030Hk-PT/H579/H579 or Ablestik 84-1LMISR4. Apply sufficient epoxy to meet required epoxy bond line thickness, epoxy fillet height and epoxy coverage around total die periphery. Parts shall be cured in a nitrogen filled atmosphere per manufacturer's cure condition. It is recommended to use antistatic die pick up tools only.
4. Wire Bonding
Bond pad openings in the surface passivation above the bond pads are provided to allow wire bonding to the dice gold bond pads. Thermosonic bonding is used with minimized ultrasonic content. Bond force, time, ultrasonic power and temperature are all critical parameters. Suggested wire is pure gold, 1 mil diameter. Bonds must be made from the bond pads on the die to the package or substrate. All bond wires should be kept as short as low as reasonable to minimize performance degradation due to undesirable series inductance.

Assembly Diagram

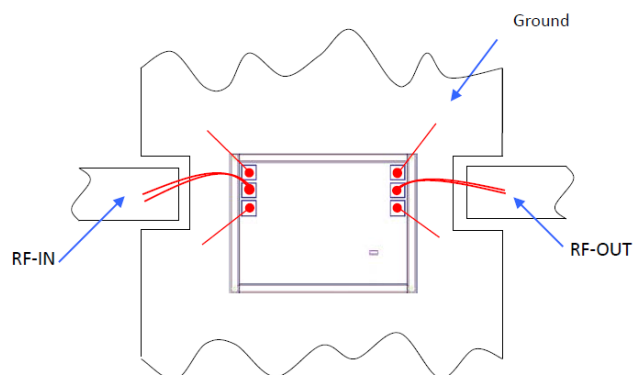

Recommended Wire Length, Typical

Wire	Wire Length (mm)	Wire Loop Height (mm)
All wires	1.0	0.15

Note: Use double bond wire at RF IN & RF OUT

