



(LTCC) COAXIAL

# High Pass Filter

## ZHFG-K3250+

50Ω 3.65 to 16.5 GHz 2.92mm Female

### KEY FEATURES

- Low Insertion Loss, 1.8 dB Typ.
- Return Loss, 12 dB Typ.
- Stop Band Rejection, 46 dB Typ.
- Broadband Connectorized Package.
- Power Handling: 3 Watts

### APPLICATIONS

- Test and Measurement Equipment.
- SATCOM.
- 5G MIMO and Back Haul Radio Systems.
- WiFi 6E.



Generic photo used for illustration purposes only

### PRODUCT OVERVIEW

ZHFG-K3250+ is a 50ohm high pass filter built in broad band connectorized package. Covering 3.65-16.5 GHz bandwidth, these units offer good matching within the passband and good rejection in stopband. ZHFG-K3250+ offer low insertion loss, and excellent power handling capability. It handles up to 3 W RF input power and provides a wide operating temperature range from -55°C to 125°C.

### FUNCTIONAL DIAGRAM

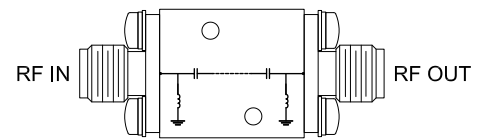

### ELECTRICAL SPECIFICATIONS<sup>1,2</sup> AT +25°C

Parameter		F#	Frequency (GHz)	Min.	Typ.	Max.	Units
Pass Band	Insertion Loss	F3-F4	3.65 - 4.3	—	2.0	—	dB
		F4-F5	4.3 - 5.5	—	1.3	2.0	
		F5-F6	5.5 - 14.1	—	1.1	1.8	
		F6-F7	14.1-16.5	—	2.2	—	
	Return Loss	F3-F4	3.65 - 16.5	—	11	—	dB
Stop Band	Rejection	DC-F1	DC - 2	38	46	—	dB
		F1-F2	2 - 2.5	27	39	—	dB
	Freq. Cut-Off <sup>3</sup>	Fc <sup>3</sup>	3.25	—	3	—	dB

1. This filter is bi-directional, RF1 and RF2 ports may be interchanged, see S-Parameters for actual performance.

2. This component should not be used as a DC-block. In applications where DC voltage and/or current is present at either the input or output ports, external DC blocking capacitors are required.

3. Typical variation ± 5%

### ABSOLUTE MAXIMUM RATINGS<sup>4</sup>

Parameter	Ratings
Operating Temperature	-55 °C to +125 °C
Storage Temperature	-55 °C to +125 °C
Input Power <sup>5</sup>	3 W @25°C

4. Permanent damage may occur if any of these limits are exceeded.

5. Power rating applies only to signals within the passband. Power rating above +25°C operating temperature decreases linearly to 0.6 W at +125°C.

### TYPICAL FREQUENCY RESPONSE AT +25°C

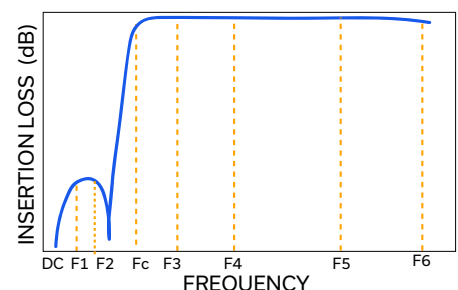



(LTCC) COAXIAL

# High Pass Filter

## ZHFG-K3250+

Mini-Circuits

50Ω 3.65 to 16.5 GHz 2.92mm Female

### TYPICAL PERFORMANCE GRAPHS

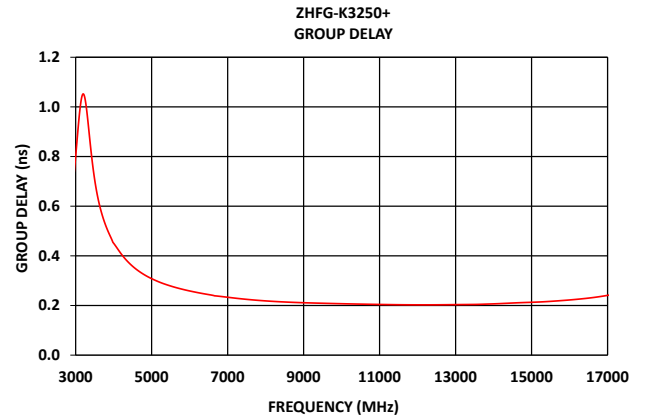
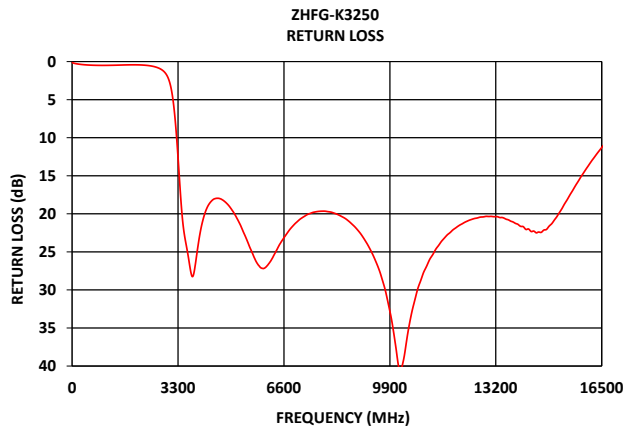
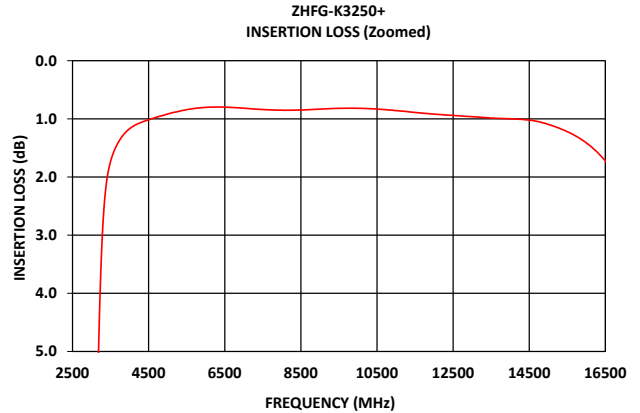
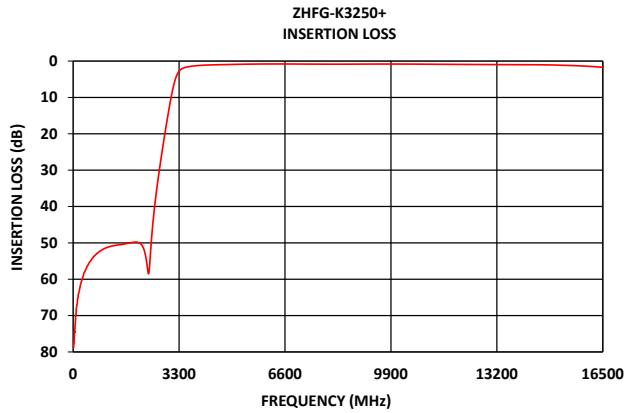



(LTCC) COAXIAL

# High Pass Filter

## ZHFG-K3250+

50Ω 3.65 to 16.5 GHz 2.92mm Female

### CONNECTOR DESCRIPTION

Function	Marking on Unit	Connector
RF1 <sup>1</sup>	1	2.92mm Female
RF2 <sup>1</sup>	2	2.92mm Female

### CASE STYLE DRAWING

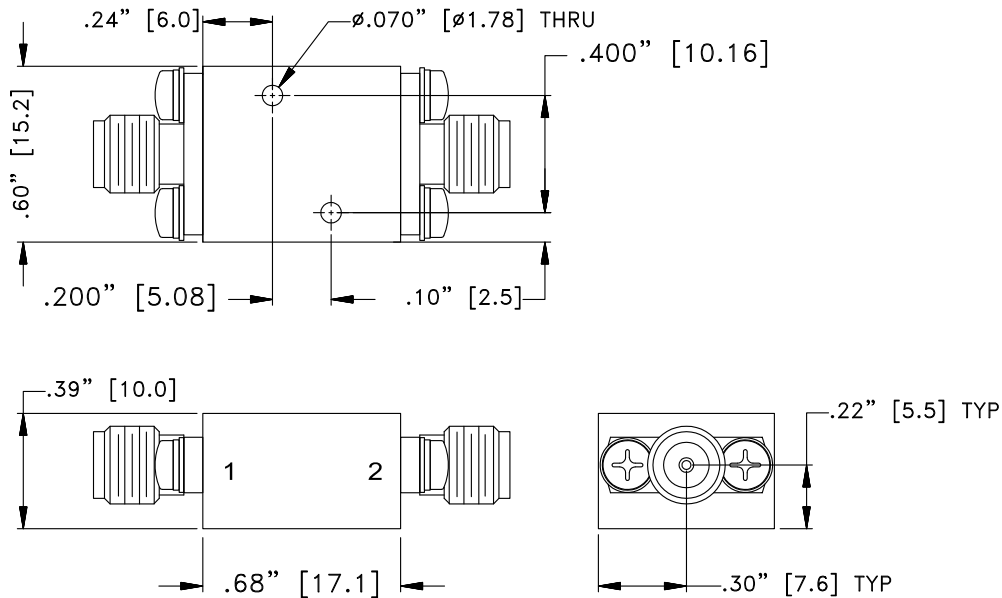

Unit weight: 24grams

Dimensions are in inches (mm). Tolerances: 2 Pl.±.050"; 3 Pl.±.015"

**PRODUCT MARKING\*:** ZHFG-K3250+

\*Marking may contain other features or characters for internal lot control.



(LTCC) COAXIAL

# High Pass Filter

## ZHFG-K3250+

50Ω 3.65 to 16.5 GHz 2.92mm Female

ADDITIONAL INFORMATION IS AVAILABLE ON OUR DASHBOARD

[CLICK HERE](#)

Performance Data & Graphs	<p>Data</p> <p>Graphs</p> <p>S-Parameter (S2P Files) Data Set (.zip file)</p>
Case Style	UK3042
RoHS Status	Compliant
Environmental Ratings	ENV124

### NOTES

- A. Performance and quality attributes and conditions not expressly stated in this specification document are intended to be excluded and do not form a part of this specification document.
- B. Electrical specifications and performance data contained in this specification document are based on Mini-Circuits' applicable established test performance criteria and measurement instructions.
- C. The parts covered by this specification document are subject to Mini-Circuits' standard limited warranty and terms and conditions (collectively, "Standard Terms"); Purchasers of this part are entitled to the rights and benefits contained therein. For a full statement of the standard terms and the exclusive rights and remedies thereunder, please visit Mini-Circuits' website at [www.minicircuits.com/terms/viewterm.html](http://www.minicircuits.com/terms/viewterm.html)

