



USB & ETHERNET

3 x SP2T Mechanical Switch Assembly ZT-317

50 Ω DC to 18 GHz Rack-Mount N-Type Female

THE BIG DEAL

- 3 x mechanical SPDT absorptive switches
- Ethernet & USB control
- High isolation, 90 dB typ
- Fail-safe / redundancy switching
- LED switch state indicators

APPLICATIONS

- Benchtop and rack mounted automated test systems
- 5G FR1, WiFi 6E, UWB, Bluetooth
- Military radio, radar & electronic warfare
- Test & measurement systems
- Switch matrices

PRODUCT OVERVIEW

Mini-Circuits' ZT-317 houses 3 independently controlled electro-mechanical SPDT switches. Each switch operates over an extremely wide bandwidth, from DC to 18 GHz with high isolation and low insertion loss. The absorptive switches are fail-safe, with a break before make configuration, and lifetime of 5 million switching cycles typically when used within the noted specifications.

The switches are housed in a compact 19-inch rack chassis with all N-type (female) RF connectors on the rear panel to enable plumbing on the back and keep the front panel clear. LED switch state indicators on the front panel enable visual display of all switch states. The switch matrix can be controlled via USB or Ethernet (supporting both HTTP and Telnet network protocols). Full software support is provided, including our user-friendly GUI application for Windows and a full API with programming instructions for Windows and Linux environments.

KEY FEATURES

Feature	Advantages
Mechanical switches	Mechanical absorptive switches provide low loss, high isolation, high reliability, repeatable performance and internal termination of input signals on the disconnected paths
Fail-safe design	The switches revert to a known default state when the DC supply is removed, allowing their use in systems that must continue to operate safely in the event of power failure
Break-before-make configuration	Prevents a momentary connection of the old and new signal paths, reducing the inconsistent transient effects that could otherwise be observed during switching
Rack-mount chassis	Compact 1U height, 19" rack-mountable chassis suits integration in automated production test environments.
Ethernet & USB control	USB HID and Ethernet (HTTP / Telnet) interfaces ensure compatibility with most software environments and connection requirements.

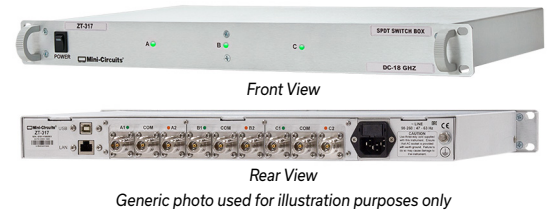

FUNCTIONAL BLOCK DIAGRAM

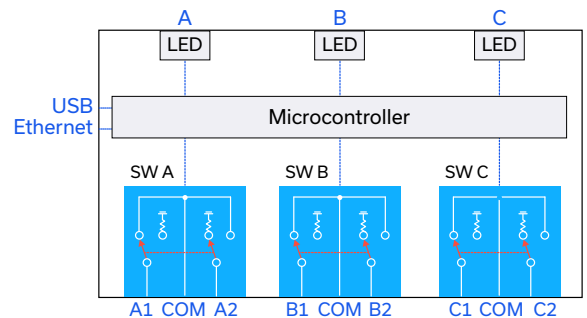

REV. C
ECO-017641
ZTM-317
MCL NY
230428



3 x SP2T Mechanical Switch Assembly **ZT-317**

ELECTRICAL SPECIFICATIONS AT +25°C

Parameter	Conditions	Min.	Typ.	Max.	Units
Frequency Range		DC		18	GHz
Insertion Loss	DC - 6 GHz		0.50	0.65	dB
	6 - 12 GHz		0.75	1.00	
	12 - 18 GHz		1.10	1.40	
Isolation	DC - 6 GHz	85	100		dB
	6 - 12 GHz	80	90		
	12 - 18 GHz	65	75		
Return Loss	DC - 6 GHz		20		dB
	6 - 12 GHz		15		
	12 - 18 GHz		12		
Switching Time			25		ms
RF Input Power	Cold switching			20	W
	Into internal termination			1	
Switch Lifetime	100 mW hot switching		5		million cycles
	1W hot switching		1		

**CONTROL INTERFACES**

Ethernet Control	Supported Protocols	TCP / IP, HTTP, Telnet, DHCP, UDP (limited)
	Max Data Rate	10 Mbps (10Base-T Half Duplex)
USB Control	Supported Protocols	HID - Full Speed
	Min Communication Time ¹	3 ms typ

1. Based on the polling interval of the USB HID protocol (1 ms with 64 bytes per packet) and no other significant CPU or USB activity

SOFTWARE & DOCUMENTATION

Mini-Circuits' full software and support package including user guide, Windows GUI, API, programming manual and examples can be downloaded free of charge (refer to the last page for the download path).

A comprehensive set of software control options is provided:

- GUI for Windows – Simple software interface for control via Ethernet and USB
- Programming / automation via Ethernet
 - Complete set of control commands which can be sent via any supported protocol – simple to implement in the majority of modern programming environments
- Programming / automation via USB
 - DLL files provide a full API for Windows with a set of intuitive functions which can be implemented in any programming environment supporting .Net Framework or ActiveX
 - Direct USB programming is possible in any other environment (not supporting .Net or ActiveX)

Please contact testsolutions@minicircuits.com for support

MINIMUM SYSTEM REQUIREMENTS

Hardware	Intel i3 (or equivalent) or later
GUI (USB or Ethernet Control)	Windows 7 or later
USB API DLL	Windows 7 or later with support for Microsoft .Net Framework or ActiveX
USB Direct Programming	Windows 7 or later; Linux
Ethernet	Windows, Linux or macOS with Ethernet TCP / IP support

PROGRAMMING COMMANDS

The key ASCII / SCPI commands for control of the system for control via the Ethernet or USB API are summarized below (refer to the programming manual for full details):

Command / Query	Description
:MN?	Read model name
:SN?	Read serial number
:FIRMWARE?	Read firmware version
SET[sw_label]=[port]	Set a single switch state: [sw_label] = A to C [port] = 0 (Com to 1) or 1 (Com to 2) Example: SETA=1 (set SPDT A with Com to A2)
SWPORT?	Get the state of all switches: <ul style="list-style-type: none"> • Returns a byte value, with the 3 least significant bits each representing the state an individual SPDT (switch A is the least significant bit). The value for each switch will be: <ul style="list-style-type: none"> • 0 = COM to Port 1 • 1 = COM to Port 2 • Example: A returned value of 6 is represented as 00000110 indicating SW C = 1 (Com to C2), SW B = 1 (Com to B2) and SW A = 0 (Com to A1)



GRAPHICAL USER INTERFACE (GUI) FOR WINDOWS

- Connect via USB or Ethernet
- Run GUI in "demo mode" to evaluate software without a hardware connection

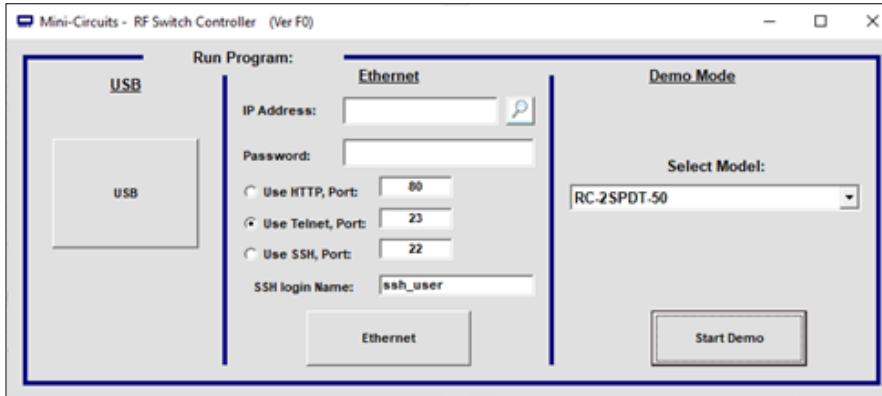

- View and set all switch states at the click of a button
- Configure automated / times switching sequences
- Configure Ethernet settings
- Update firmware

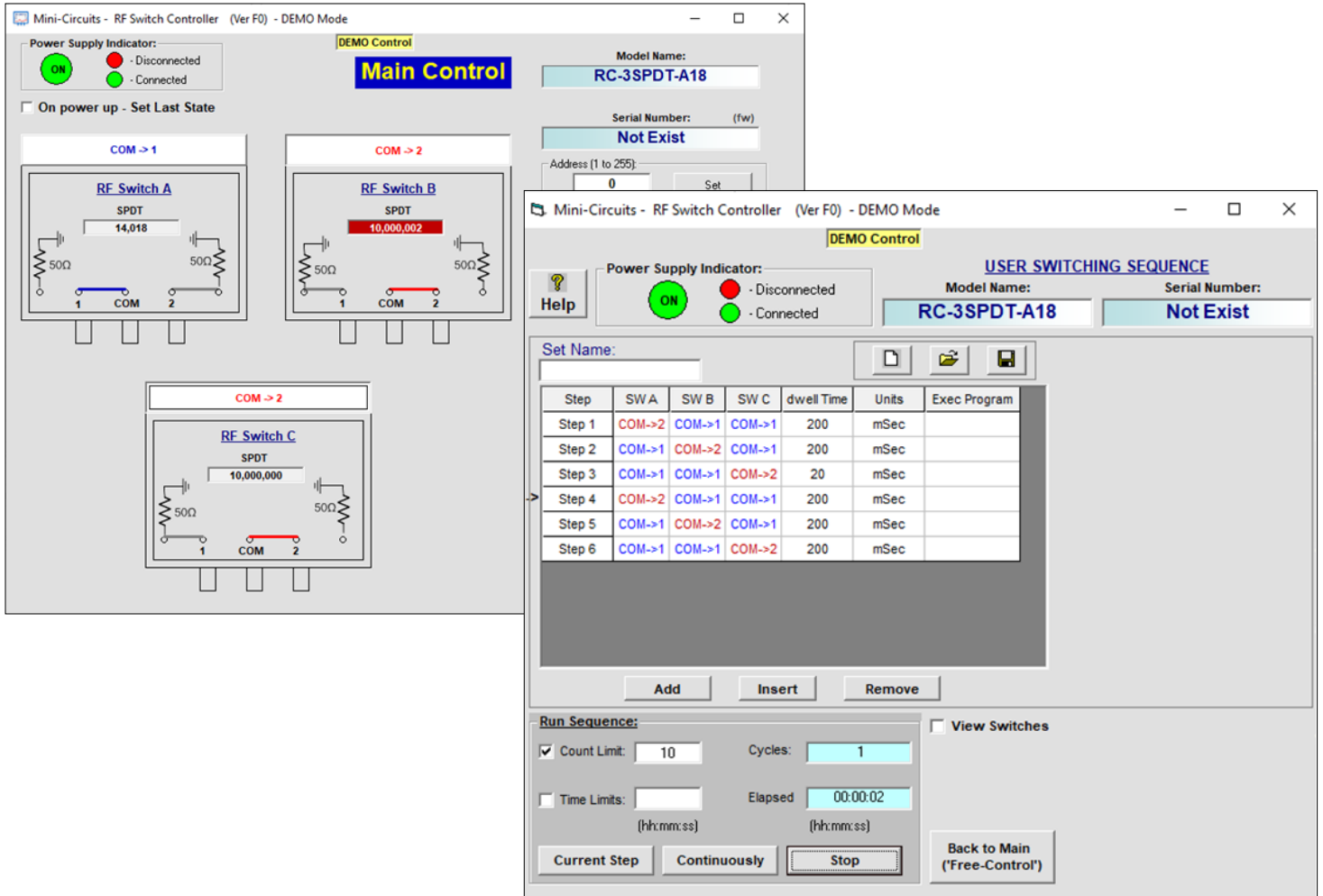



TYPICAL PERFORMANCE CURVES

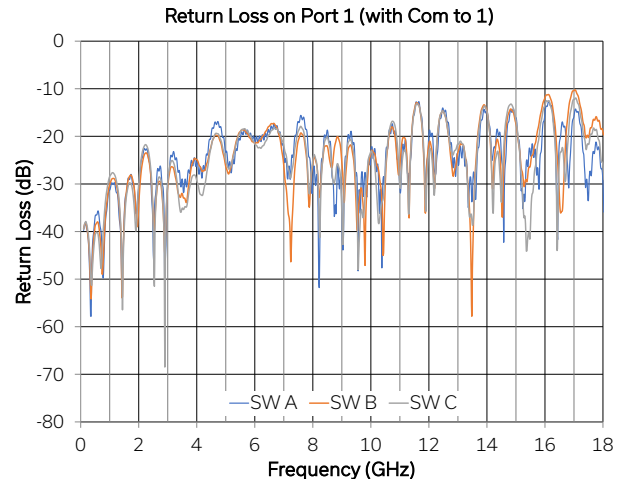
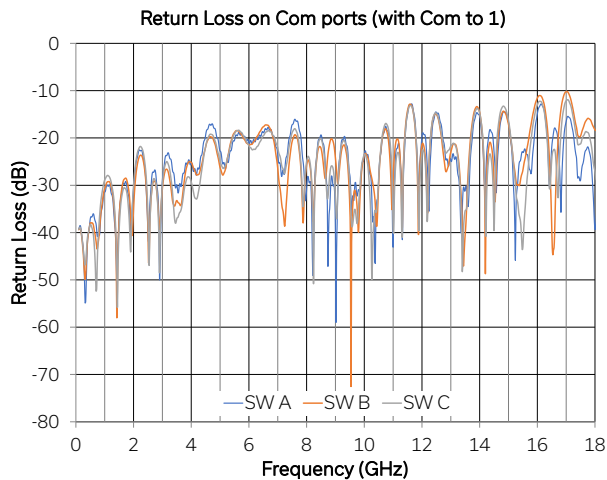
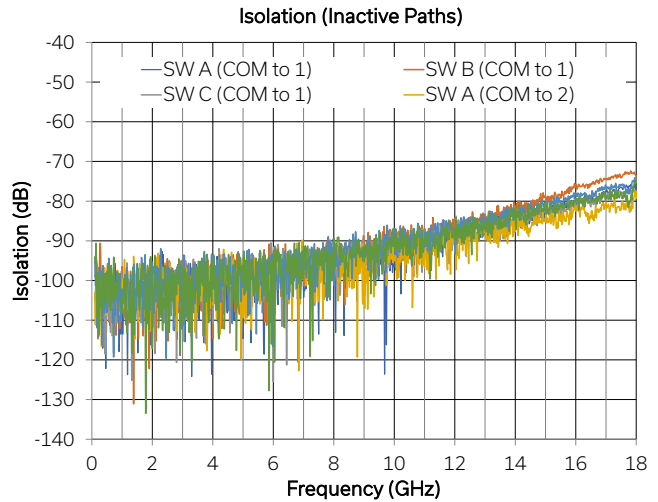
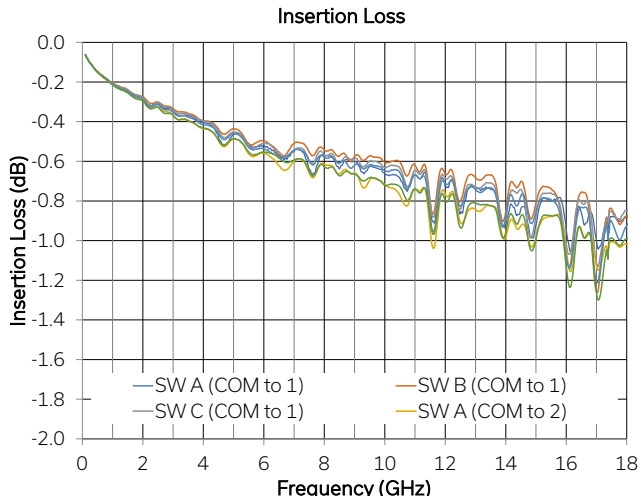



USB & ETHERNET

3 x SP2T Mechanical Switch Assembly **ZT-317**

50 Ω DC to 18 GHz Rack-Mount N-Type Female

ABSOLUTE MAXIMUM RATINGS

Parameter	Conditions	Limits	Units
Temperature	Operating	0 to +40	°C
	Storage	-15 to +85	
Input Power (No Damage)	Cold switching	20	W
	Hot switching	1	
	Into internal termination	1	

Permanent damage may occur if any of these limits are exceeded. Operating in the range between operating power limits and absolute maximum ratings for extended periods of time may result in reduced life and reliability.

POWER SUPPLY

Power Supply	AC mains input: 100-240 V, 50 / 60 Hz
Fuse	2A, 250V rating
Power Consumption	85W maximum

FUNCTIONAL BLOCK DIAGRAM

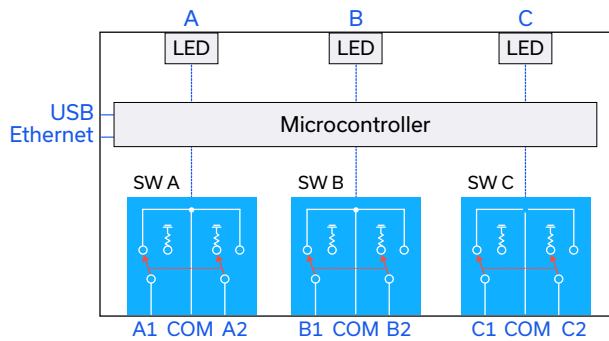

CONNECTIONS

Port	Connector
SW A - COM, A1 & A2	N-type female
SW B - COM, B1 & B2	N-type female
SW C - COM, C1 & C2	N-type female
USB	USB type B
Ethernet / LAN	RJ45
AC Input	IEC C14 inlet

COM = Common port
A1, A2, B1, B2, C1, C2 = Input / output ports

SWITCH CONTROL LOGIC

Switch Command	Switch State			Front Panel LED Color		
	A	B	C	A	B	C
SETA=0	Com to A1	x	x	Green	x	x
SETA=1	Com to A2	x	x	Orange	x	x
SETB=0	x	Com to B1	x	x	Green	x
SETB=1	x	Com to B2	x	x	Orange	x
SETC=0	x	x	Com to C1	x	x	Green
SETC=1	x	x	Com to C2	x	x	Orange

x = Switch / LED state not affected by this switch command



3 x SP2T Mechanical Switch Assembly ZT-317

50 Ω DC to 18 GHz Rack-Mount N-Type Female

CASE STYLE DRAWING

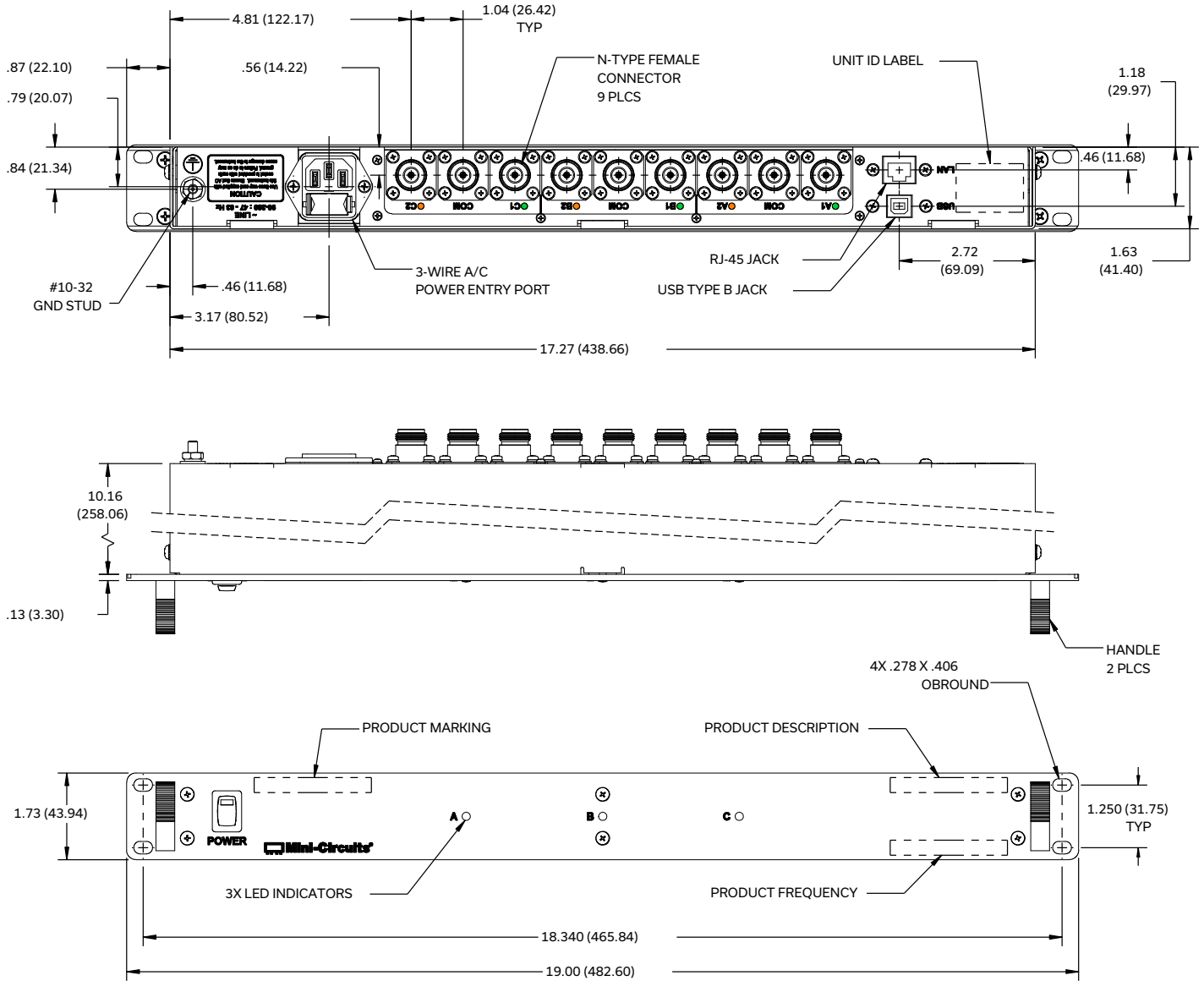

1. Case material: Aluminum (with protective coating to prevent corrosion).
2. Dimensions are in inches (mm). Tolerances: 2 Pl.±.03 inch; 3 Pl.±.015 inch.
3. Weight: 3100 grams.
4. Marking may contain other features or characters for internal lot control.

PRODUCT MARKING*

ZT-317
 SPDT Switch Matrix
 DC-18 GHz
 Serial Number

*Marking may contain other features or characters for internal lot control



USB & ETHERNET



3 x SP2T Mechanical Switch Assembly **ZT-317**





50 Ω DC to 18 GHz Rack-Mount N-Type Female

DETAILED MODEL INFORMATION IS AVAILABLE ON OUR WEBSITE [CLICK HERE](#)

Case Style	NW3004
Software, User Guide & Programming Manual	www.minicircuits.com/softwaredownload/rfswitchcontroller.html
Environmental Rating	ENV56
Regulatory Compliance	<p>Refer to our website for compliance methodologies and qualifications</p>  <p>www.minicircuits.com/quality/environmental_introduction.html</p>

Contact Us: testsolutions@minicircuits.com

Included Accessories	Part Number	Description
	CBL-3W-xx	AC power cord (IEC C13 connector to local plug) Select one option from the list below. Please contact testsolutions@minicircuits.com if your region is not listed.
	USB-CBL-AB-7+	USB cable (6.8ft) type A to type B
	CBL-RJ45-MM-5+	Ethernet cable (5 ft)

AC Power Cord Options	Part Number	Description
	CBL-3W-US	USA NEMA 5-15 plug (type B) to IEC C13 connector
	CBL-3W-EU	Europe CEE 7/7 plug (type E/F) to IEC C13 connector
	CBL-3W-UK	UK BS-1363 plug (type G) to IEC C13 connector
	CBL-3W-AU	Australia & China AS/NZS 3112 plug (type I) to IEC C13 connector
	CBL-3W-IL	Israel SI-32 plug (type H) to IEC C13 connector

- NOTES**
- A. Performance and quality attributes and conditions not expressly stated in this specification document are intended to be excluded and do not form a part of this specification document.
 - B. Electrical specifications and performance data contained in this specification document are based on Mini-Circuit's applicable established test performance criteria and measurement instructions.
 - C. The parts covered by this specification document are subject to Mini-Circuits standard limited warranty and terms and conditions (collectively, "Standard Terms"); Purchasers of this part are entitled to the rights and benefits contained therein. For a full statement of the standard. Terms and the exclusive rights and remedies thereunder, please visit Mini-Circuits' website at www.minicircuits.com/MCLStore/terms.jsp

