

Outline Dimensions

WC3071-7

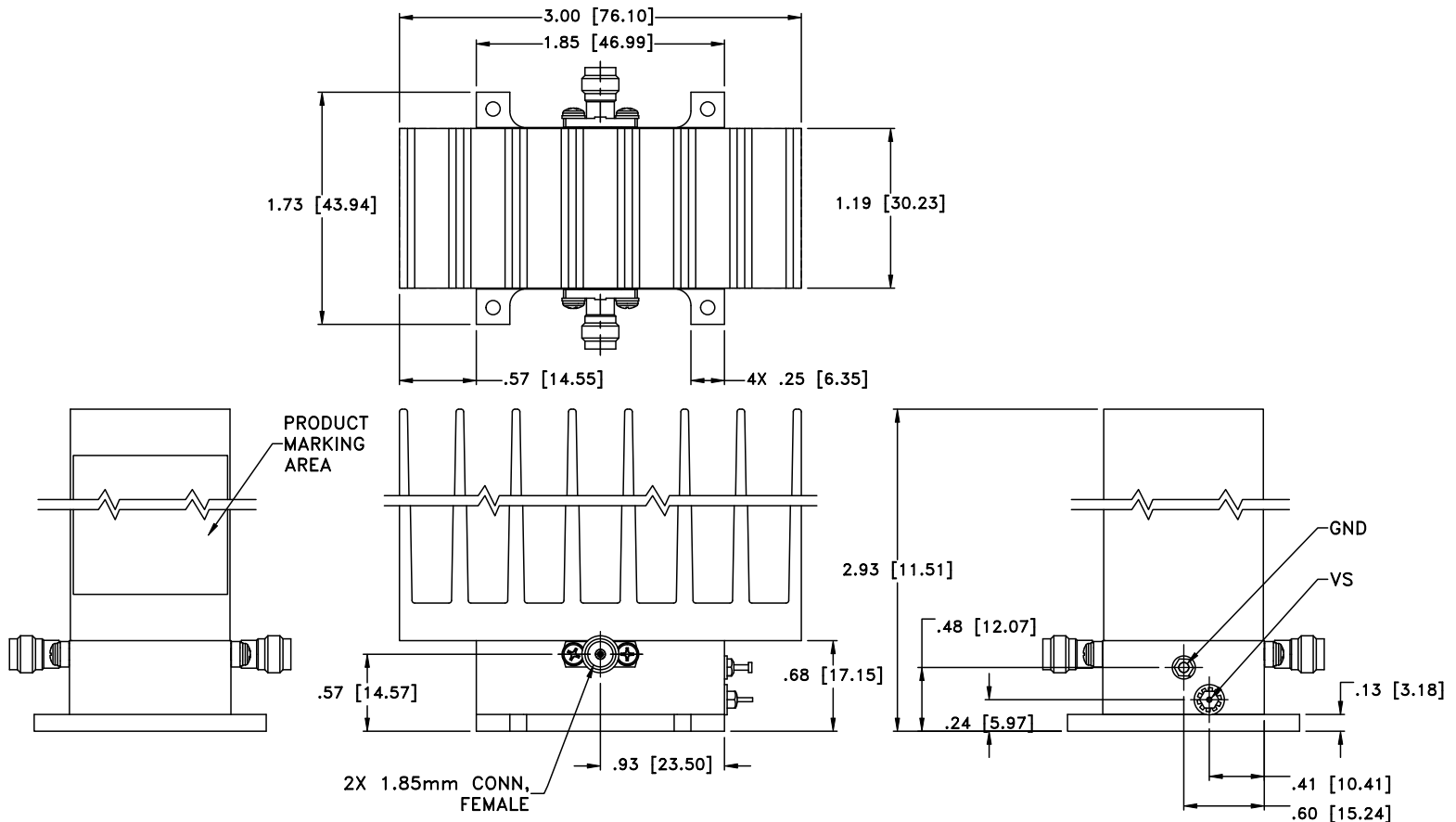

MOUNTING INFORMATION OF MODEL WITHOUT HEATSINK

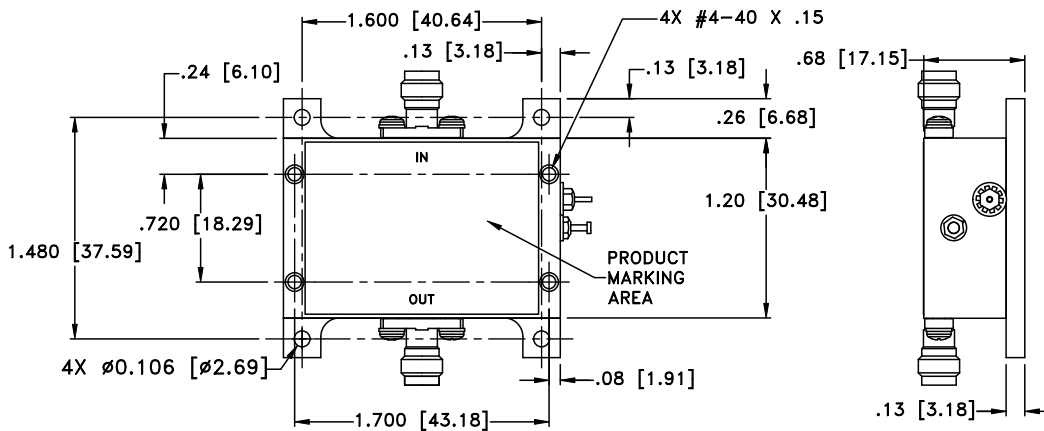

WT. WT. GRAMS 160 grams; WITHOUT HEATSINK GRAMS 60 grams

Dimensions are in inches (mm). Tolerances: 2 Pl.±.03; 3 Pl. ±.015

Notes:

1. Case material: Aluminum.
2. Case finish: Gold plating;
3. Heat sink finish: Black anodize.
4. Refer to the individual model data sheet for the type of connectors available.
5. Shape of connector flange may vary.

Mini-Circuits®
ISO 9001 ISO 14001 CERTIFIED

ALL NEW
minicircuits.com

P.O. Box 350166, Brooklyn, New York 11235-0003 (718) 934-4500 Fax (718) 332-4661 For detailed performance specs & shopping online see Mini-Circuits web site



The Design Engineers Search Engine Provides ACTUAL Data Instantly From MINI-CIRCUITS At: www.minicircuits.com

RF/IF MICROWAVE COMPONENTS