

Evaluation Board and Circuit

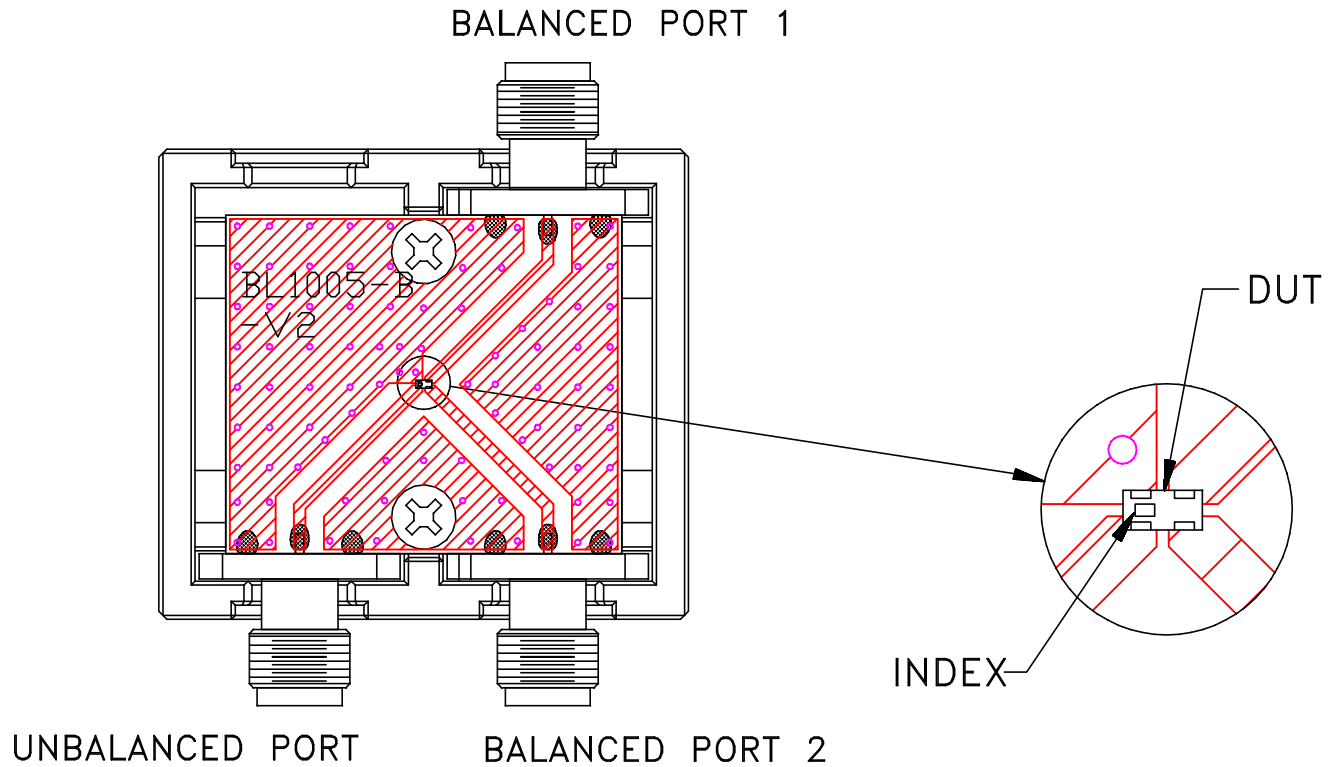

TB-1012-2542+

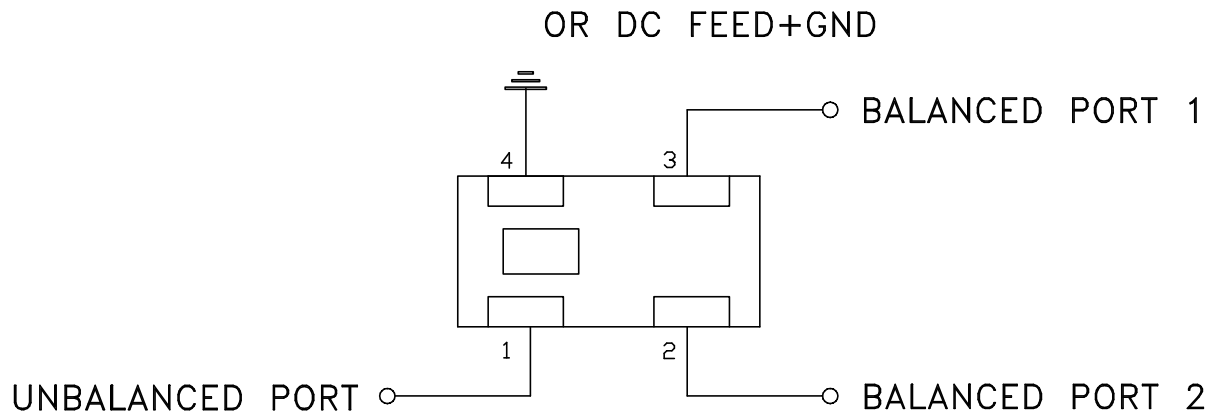

Schematic Diagram

Notes:

1. 50 Ohm SMA Female connectors.
2. PCB Material: FR4 or equivalent,
Dielectric Constant=4.5, Thickness=.016 inch.

 **Mini-Circuits®**