

Evaluation Board and Circuit

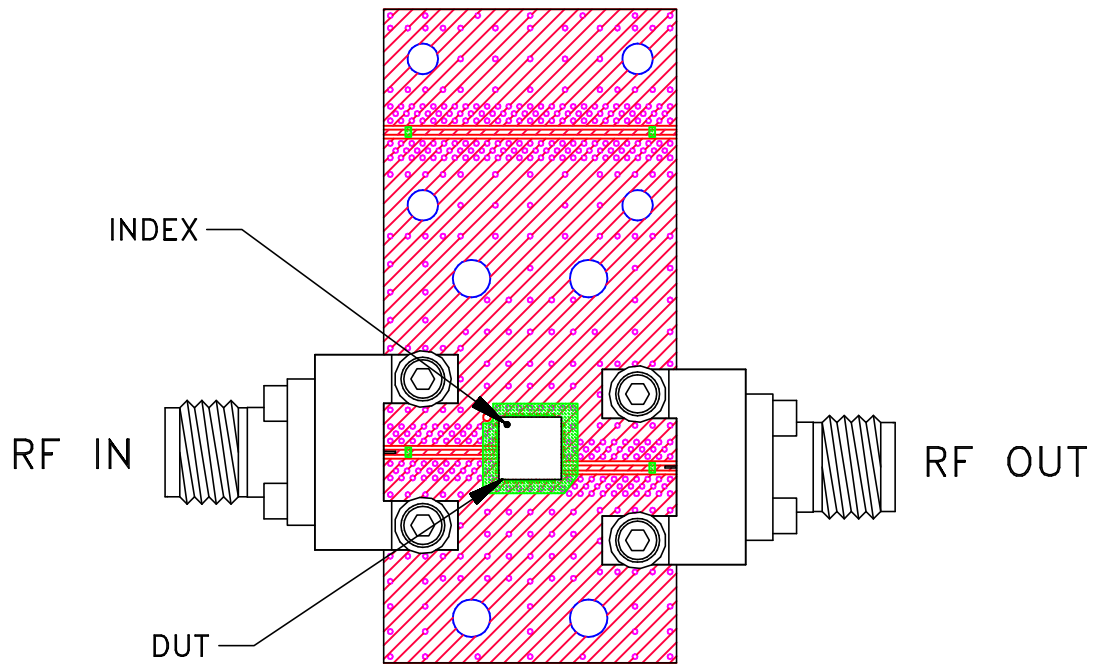

TB-968-24+

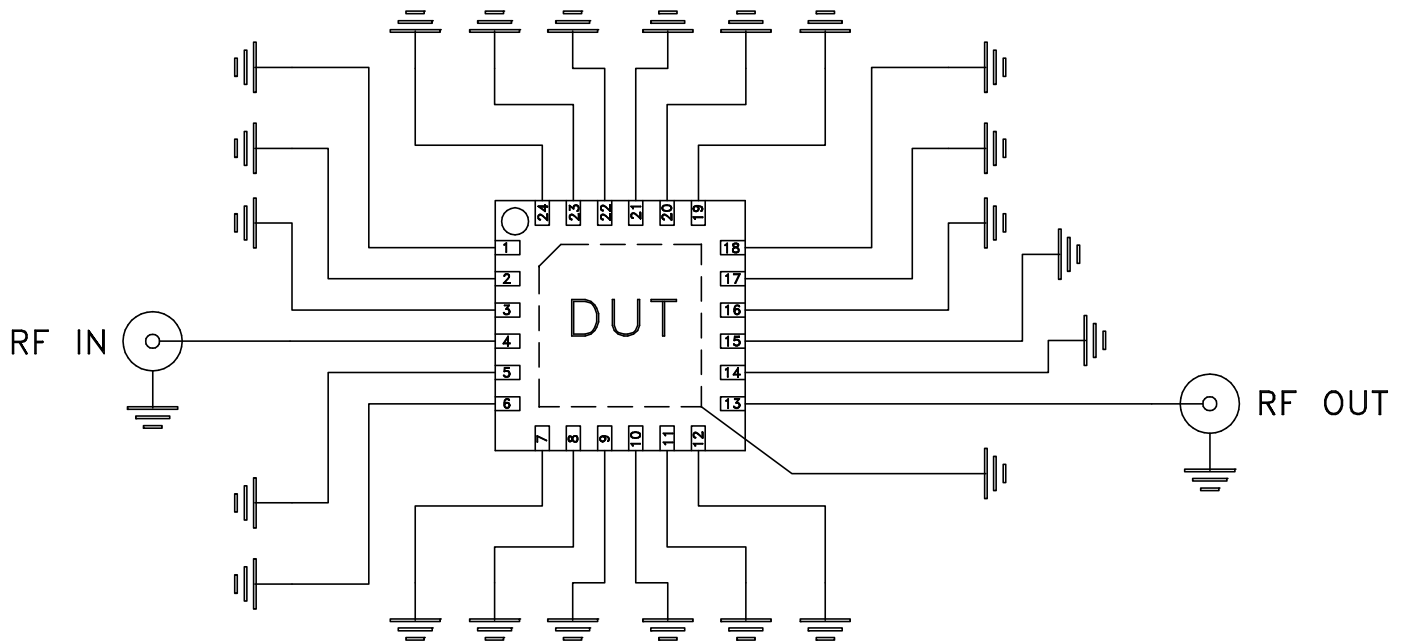

Schematic Diagram

Note:

PCB Material: RO4003C or equivalent,
Dielectric Constant=3.5, Thickness=.008 inch.

 **Mini-Circuits®**