

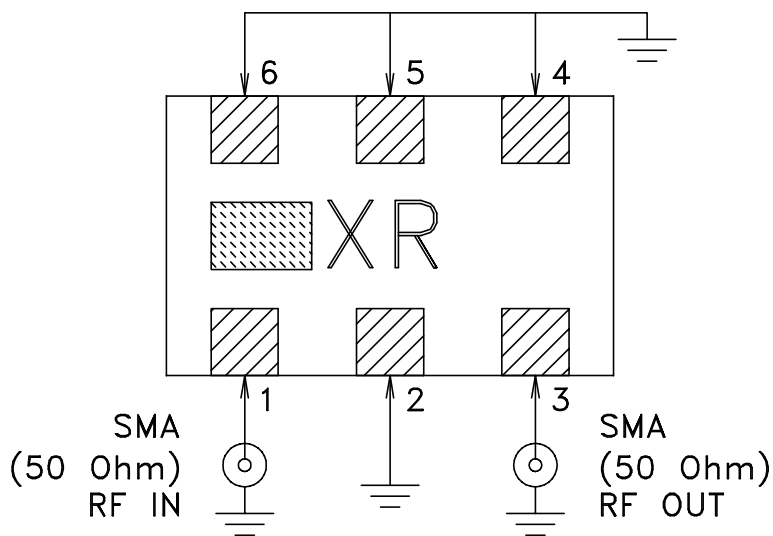

Evaluation Board and Circuit

TB-HFCG-880+

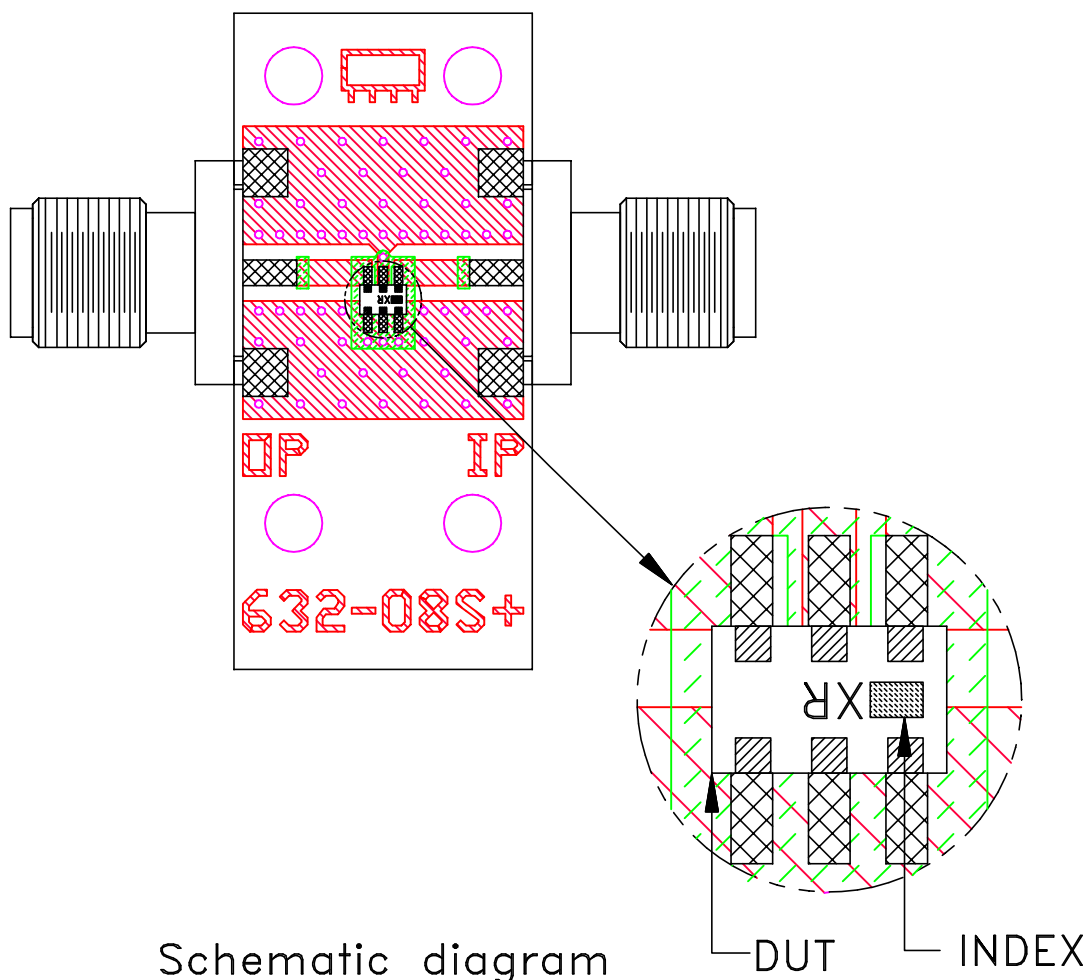

Notes:

1. PCB Material: ROGERS (R04350B) OR Equivalent, Dielectric Constant= 3.48 ± 0.05
Dielectric Thickness: $.020 \pm .0015$ inch
2. 50 Ohm SMA Female Connectors.

 **Mini-Circuits®**