

Millimeter Wave | USB & Ethernet Frequency Extender

FX-30G-RC

50Ω 10 MHz to 30 GHz

The Big Deal

- Multiply 15 GHz signal source to 30 GHz
- Buffer input signals for +20 dBm output level
- Integrates seamlessly with SSG-15G-RC signal generator
- **USB and Ethernet control**

Typical Applications

- Wideband signal generator / LO source
- 5G FR2 bands n257, n258 & n261
- K & Ku band radar
- Microwave & millimeter wave radio testing

Product Overview

Mini-Circuits FX-30G-RC is a wideband frequency extender and buffer module, designed to multiply an existing 15 GHz signal source for operation up to 30 GHz.

Stand-Alone Frequency Extender & Buffer Amplifier

As a stand-alone unit, the FX-30G-RC will switch automatically between signal paths according to the output frequency requested by the user. The low-band path covers 10 MHz to 15 GHz and allows a signal source to be passed straight from input to output via a 20 dB buffer amplifier, for output levels up to +23 dBm. The high-band path allows the same input frequency range to be routed through a doubler with gain control and harmonic filtering, extending the original 15 GHz signal source up to 30 GHz.

The system is controlled via Ethernet or USB using Mini-Circuits' powerful GUI for Windows or comprehensive API. SSH, HTTP & Telnet protocols are supported via Ethernet, with programming support for most common languages.

Cost effective 10 MHz to 30 GHz Signal generator

FX-30G-RC integrates seamlessly with Mini-Circuits' SSG-15G-RC to create a single, cost effective, millimeter wave signal generator, offering CW and pulsed outputs from 10 MHz to 30 GHz. All required accessories are included and can be set up in moments, just connect the RF and serial control cables between the signal source and frequency extender modules, plug in the power supply and turn on.

Refer to <https://www.minicircuits.com/WebStore/dashboard.html?model=SSG-30G-RC> for the full specifications and features when configured as a 10 MHz to 30 GHz signal generator

Key Features

Feature	Advantages
USB & Ethernet control	USB HID and Ethernet (HTTP / Telnet / SSH) interfaces provide easy compatibility with a wide range of software setups and programming environments.
Works with SSG-15G-RC	The FX-30G-RC is designed to interface seamlessly with the SSG-15G-RC, effectively providing the user a single 10 MHz to 30 GHz generator using the standard SSG software with all available functions.
Full software support included	Mini-Circuits' full software package, programming and user manual are available for download from https://www.minicircuits.com/softwaredownload/sg.html .

Trademarks: Windows is a registered trademark of Microsoft Corporation in the United States and other countries. Linux is a registered trademark of Linus Torvalds. Mac is a registered trademark of Apple Corporation. SSH is a registered trademark of SSH Communications Security Corp. Pentium is a registered trademark of Intel Corporation. Neither Mini-Circuits nor the Mini-Circuits FX-series Frequency Extenders are affiliated with or endorsed by the owners of the above referenced trademarks.

Mini-Circuits and the Mini-Circuits logo are registered trademarks of Scientific Components Corporation.



Software Package Case Style: SL3225
Included Accessories

Model No.	Description	Qty.
AC/DC-12-3W	AC/DC 12V adapter (see Ordering Information)	1
CBL-3W-XX	AC power cord (see Ordering Information)	1
141-5SM+	RF Interconnect cable	1
CBL-0.5FT-MMD+	Control cable for connecting to SSG-15G-RC	1
USB-CBL-AC-3+	3.3 ft. USB cable	1

RoHS Compliant

See our web site for RoHS Compliance methodologies and qualifications

Process flow chart

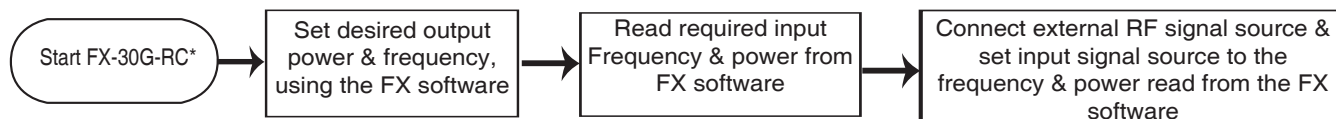

* Control is via either USB or Ethernet

Block diagram

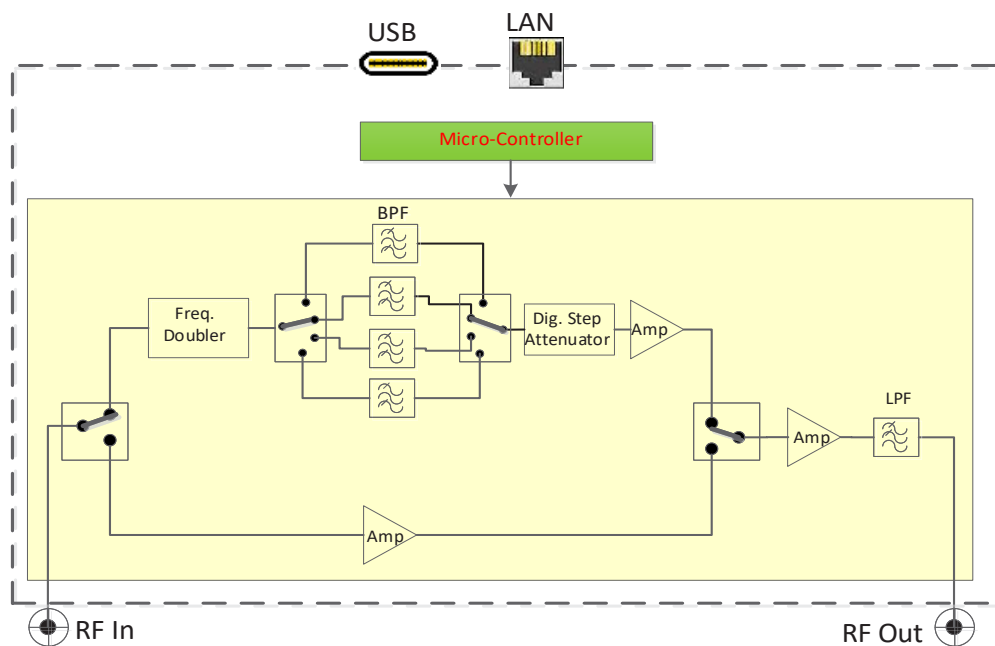

Electrical Specifications at +25°C

General Specifications

Parameter	Test Conditions	Min.	Typ.	Max.	Units
Output Frequency	-	10	-	30,000	MHz
Input Frequency	-	10	-	15,000	
Band switching time ^{1,2}	-	-	300	450	µs
VSWR In	10 - 50 MHz	-	2.45	-	:1
	50 - 4,500 MHz	-	1.45	-	
	4,500 - 12,000 MHz	-	1.40	-	
	12,000 - 15,000 MHz	-	1.35	-	
VSWR Out	10 - 15,000 MHz	-	1.35	-	
	15,000 - 21,200 MHz	-	1.35	-	
	21,200 - 30,000 MHz	-	1.50	-	

¹ Time from start of transition between any two bands to settled RF output level, excluding communication delays (see page 3 for communication delays)

² The FX-30G-RC has 5 frequency bands: 0.01-15 GHz, 15-17.8 GHz, 17.8-21.2 GHz, 21.2-25.2 GHz and 25.2-30 GHz.

Electrical Specifications at +25°C

Low Band (Buffer amplifier) specifications

Operates as a buffer amplifier, input frequency is the same as output frequency.

The FX-30G-RC will calculate the required power level for a requested output power and frequency when queried.

Parameter	Test Conditions	Min.	Typ.	Max.	Units
Output Frequency	-	10	-	15,000	MHz
Input Frequency	-	10	-	15,000	
Input Power	10 - 15,000 MHz	-	-	13	dBm
Output power Max ^{3, 4}	10 - 15,000 MHz	+20	+23	-	dBm
Gain @ 0 dBm RF Output	10 MHz	-	30.7	-	dB
	5,000 MHz	-	21.8	-	
	10,000 MHz	-	17.4	-	
	15,000 MHz	-	12.4	-	
Power Out @ 1dB Compression	10 MHz	-	21	-	dB
	5,000 MHz	-	24	-	
	10,000 MHz	-	22	-	
	15,000 MHz	-	18.5	-	
Output power accuracy ⁵	10 - 15,000 MHz	-	±0.70	-	dB
Harmonics	10 - 15,000 MHz	-	-40	-	dBc
Non-Harmonic Spurious	-	-	-70	-	dBc

³ The frequency extender is calibrated within typical power range, however performance is guaranteed only within power max/min limits.

⁴ Saturation power level.

⁵ Power accuracy not including any deviation in power in from required level.

High band (Frequency Doubler mode) specifications

Operates as a frequency doubler with 4 frequency bands and power control, input frequency is half the output frequency. Specifications are for input power of +10 dBm.

Parameter	Test Conditions	Min.	Typ.	Max.	Units	
Output Frequency	-	10	-	30,000	MHz	
Input Frequency	-	10	-	15,000		
Band switching time ^{6,7}	-	300	450	μs		
Input Power	7,500 - 15,000 MHz	8.5	10	13	dBm	
Setable output power range	15,000 - 30,000 MHz	-50	-	+23	dBm	
Output Power resolution ⁸	15,000 - 30,000 MHz	-	0.5	-	dB	
Output power Max ⁸	15,000 - 21,000 MHz	+20	+23	-	dBm	
	21,000 - 27,000 MHz	+17	+19	-		
	27,000 - 30,000 MHz	+14	+17	-		
Output power Min ⁸	15,000 - 30,000 MHz	-	-47	-45	dBm	
Dynamic range	-	-	60	-	dB	
Output power accuracy ⁸	15000 - 21,200 MHz	PWR _{out} : -45 to +20 dBm	-	±1.00	-	dB
	21,200 - 27,000 MHz	PWR _{out} : -45 to +17 dBm	-	±1.00	-	
	27,000 - 30000 MHz	PWR _{out} : -45 to +14 dBm	-	±1.00	-	
Harmonics ⁸	15,000 - 30,000 MHz	-45 to -25 dBm ⁹	-	-30	-	dBc
		-25 to Max power	-	-60	-	
Sub-Harmonics ⁸	15,000 - 30,000 MHz	-45 to -25 dBm ⁹	-	-10	-	dBc
		-25 to Max power	-	-45	-	
Non-Harmonic Spurious	-	-	-70	-	dBc	
Additive Phase Noise ^{9,10}	15,000 - 30,000 MHz	-	6	-	dB	

⁶ Time from start of transition between any two bands to settled RF output level, excluding communication delays (see details below)

⁷ The FX-30G-RC has 5 frequency bands: 0.01-15 GHz, 15-17.8 GHz, 17.8-21.2 GHz, 21.2-25.2 GHz and 25.2-30 GHz.

⁸ The frequency extender is calibrated within typical power range, however performance is guaranteed only within power max/min limits.

⁹ Frequency doubling degrades the phase noise of the input signal by 6 dB

¹⁰ Tested with 50Ω source and tester.

DC Specifications

Parameter	Test Conditions	Min.	Typ.	Max.	Units
Supply Voltage	-	11.4	12	12.6	V _{DC}
Supply Current,	-	-	650	800	mA
USB current ¹⁰	-	-	0	-	

¹⁰ All power is drawn from power adaptor, however USB protocol monitors the voltage at USB port as part of the handshake protocol establishing communication.

Communication parameters

Parameter	Test Conditions	Min.	Typ.	Max.	Units
Ethernet Communication	Protocol	TCP / IP, HTTP, Telnet, SSH, DHCP, UDP (limited)			
	Max Data Rate	100 Mbps (100 Base-T Full Duplex)			
USB Communication	Protocol	HID (Human Interface Device) - High Speed			
	Min Communication Time ¹¹	400 µs typ (full transmit/receive cycle)			

¹¹ USB min communication time is based on the polling interval of the USB HID protocol(125 µs polling interval, 1024 bytes per packet), medium CPU load and no other high speed USB devices using the USB bus.

Absolute Maximum Ratings (Exceeding these limits will cause permanent damage)

Operating Temperature	0°C to +50°C	
Storage Temperature	-20°C to +60°C	
Reverse Power(DC) @ RF Out	16 V _{DC}	
Reverse Power(RF) @ RF Out	@ 10 - 100 MHz	Derates linearly from +22 dBm at 100 MHz to +13 dBm at 10 MHz
	@ 100 - 15,000 MHz	+22 dBm
	@ 15,000 - 30,000 MHz	+21 dBm
Power In @ RF In	@ 10 - 15,000 MHz	+14 dBm
	@ 15,000 - 30,000 MHz	+17 dBm

Operating in the range between operating power limits and absolute maximum ratings for extended periods of time may result in reduced life and reliability.

Typical Performance Curves*

*at +25°C unless noted otherwise

Power Accuracy vs. Output Frequency

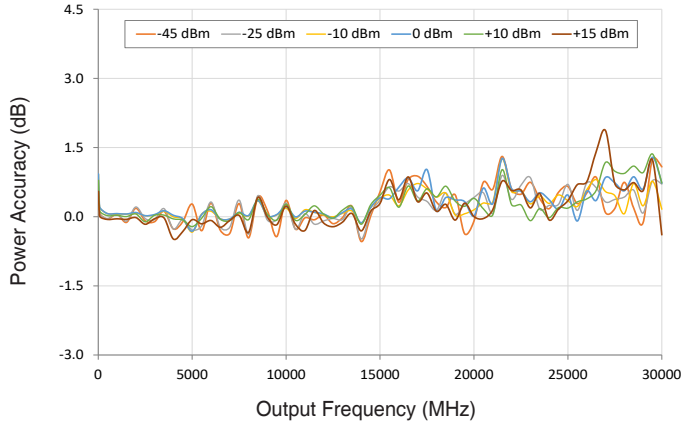

Power Accuracy vs. Output Power

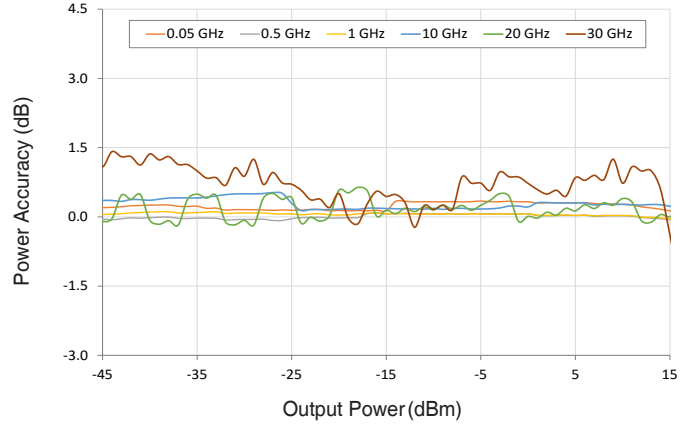

Harmonics vs. Output Frequency @ +10 dBm

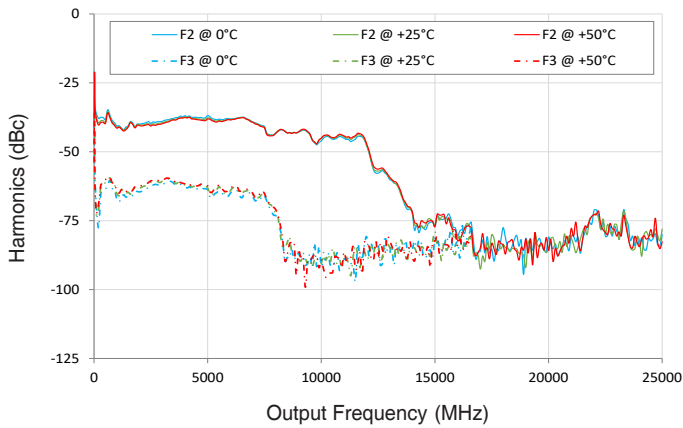

Sub-Harmonics vs. Output Frequency @ +10 dBm

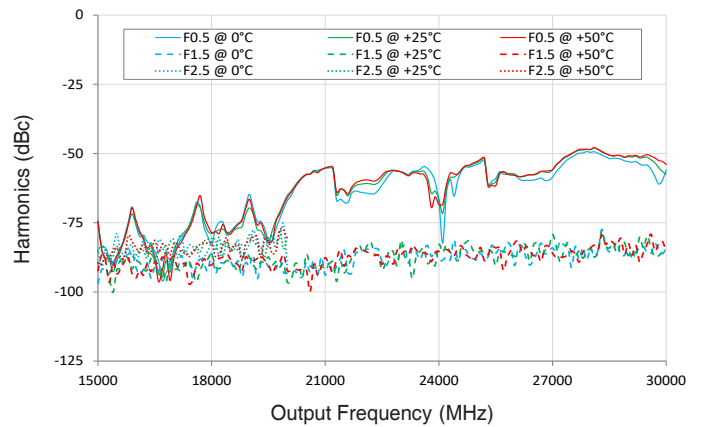

Typical Performance Curves* (continued)

Harmonics vs. Output Frequency @ -20 dBm

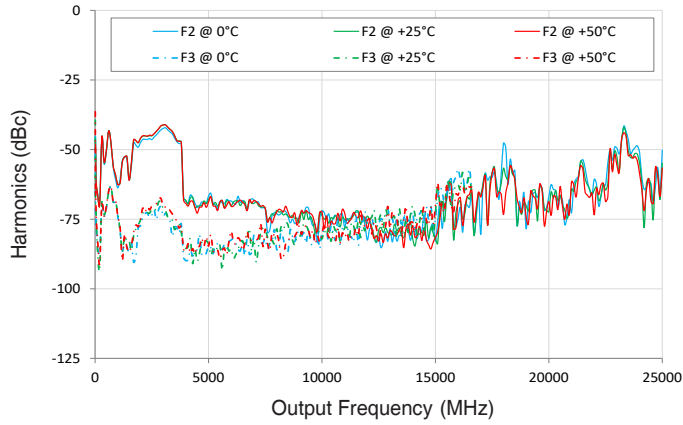

Sub-Harmonics vs. Output Frequency @ -20 dBm

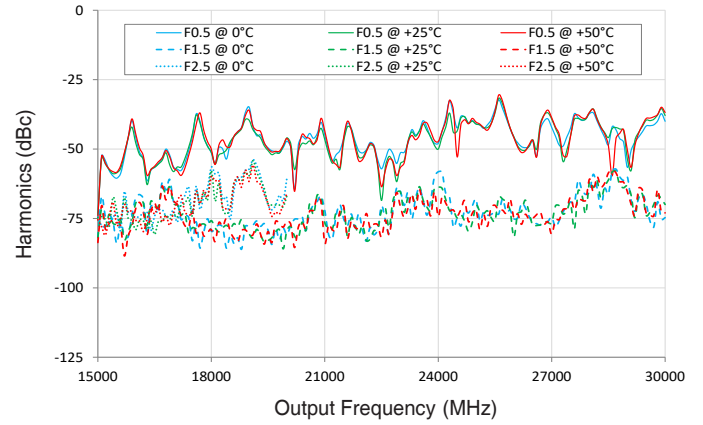

Harmonics vs. Output Frequency @ -45 dBm

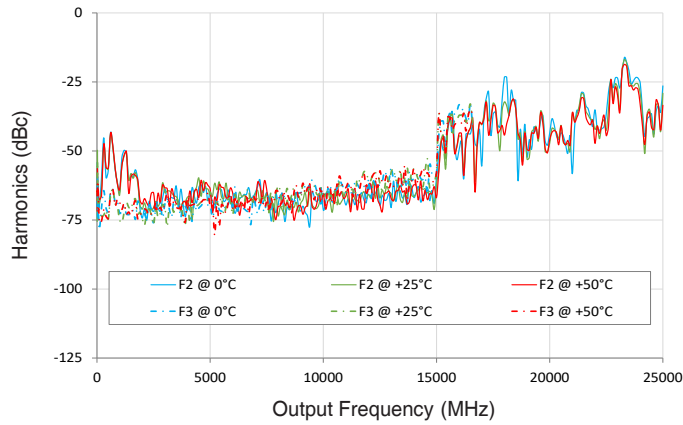

Sub-Harmonics vs. Output Frequency @ -45 dBm

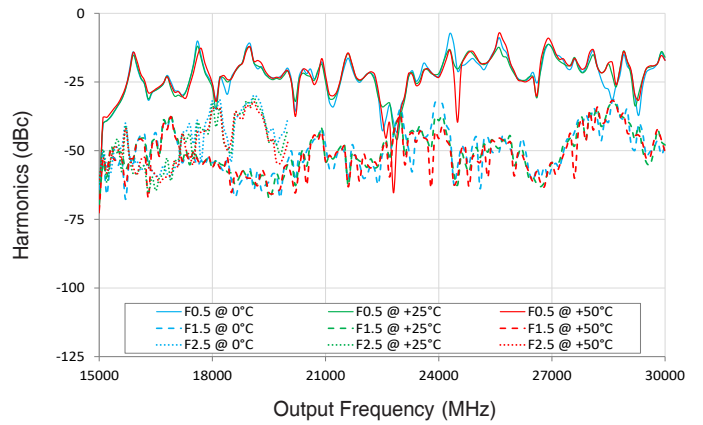

Outline Drawing SL3225

Connections

Name	Type	Description
J1	SMA (F)	RF input
J2	2.92 mm (F)	RF Output
DC2	2.1 mm DC socket	DC Power In (12V) ¹²
USB2	USB Type Mini-B	USB Port
LAN2	RJ45 socket	Network (Ethernet/LAN)
SF2	Digital snap-fit	Serial Control

¹² No power On/Off switch. device will power on as soon as power is connected, starting at Max frequency band, minimum power

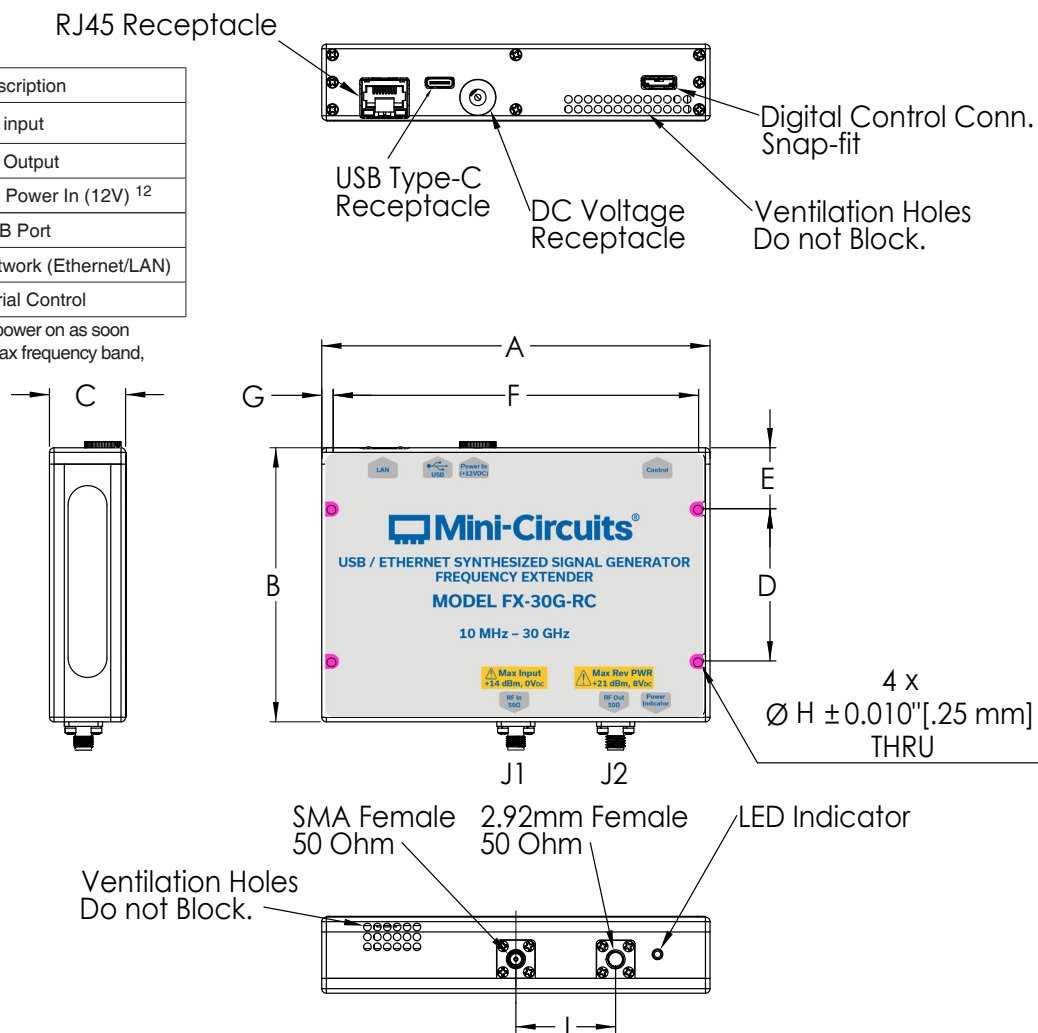

Outline Dimensions (inch/mm)

A	B	C	D	E	F	G	H	J	WT. GRAMS
5.10	3.60	1.00	2.000	0.800	4.800	0.150	0.125	1.310	600
129.5	91.4	25.4	50.80	20.32	121.92	3.81	3.18	33.27	

Software & Documentation Download:

- Mini-Circuits' full software and support package including user guide, Windows GUI, DLL files, programming manual and examples can be downloaded free of charge from <https://www.minicircuits.com/softwaredownload/sg.html>
- Please contact testsolutions@minicircuits.com for support

Minimum System Requirements

Parameter	Requirements	
Interface	USB HID or HTTP Get/Post or Telnet protocols or SSH protocols	
System requirements	GUI	Windows 32 & 64 bit systems from Windows 98 up to Windows 10
	USB API (ActiveX & .Net)	Windows 32 & 64 bit systems with ActiveX or .Net support from Windows 98 up to Windows 10
	USB direct programming support	Linux, Windows systems from Windows 98 up to Windows 10
	Ethernet	Windows, Linux or Mac computer with a network port and Ethernet TCP/IP support
Hardware	Pentium® II or higher, RAM 256 MB	

Application Programming Interface (API)

Ethernet Support:

- Simple ASCII / SCPI command set to control the FX model
- Communication via HTTP, Telnet and SSH
- Supported by most common programming environments

USB support (Windows):

- API DLL files exposing the full switch functionality
 - ActiveX COM DLL file for creation of 32-bit programs
 - .Net library DLL file for creation of 32 / 64-bit programs
 - Supported by most common programming environments (refer to application note [AN-49-001](#) for summary of tested environments)
 - Simple ASCII / SCPI command set to control the FX model

Linux Support:

- Direct USB programming using a series of USB interrupt codes.

Graphical User Interface (GUI) for Windows



Key Features:

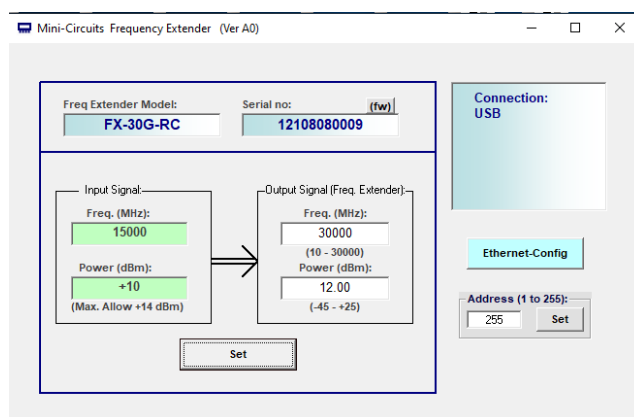



- Calculate power and Frequency input for a given RF Out.
- Set power out in 15 - 30 GHz range
- Set mode automatically according to requested frequency.
- USB and Ethernet control
- Configure Ethernet settings
- Update firmware



Ordering, Pricing & Availability Information see our web site

Model	Description	
FX-30G-RC	USB/Ethernet Frequency Extender	

Included Accessories	Part No.	Description	Qty.
	AC/DC-12-3W	AC/DC Grounded Power adapter. 0°C to +40°C AC Input: 100-240V, 50/60 Hz, I _{Max} =1.2A DC Output 12±0.6 V, I _{Max} =3A	1
	CBL-3W-XX	AC Power Cord (<i>Select one power cord from below with each Signal Generator</i>)	1
	141-5SM+	3 in. (7.5 cm) RF cable for connecting SSG-15G-RC to FX-30G-RC	1
	CBL-0.5FT-MMD+	3 in. (7.5 cm) control cable for connecting SSG-15G-RC to FX-30G-RC	1
	USB-CBL-AC-3+	3.3 ft (1.0 m) USB Cable: USB type A(Male) to USB type C(Male)	1

AC Power Cords ¹³	Part No.	Description
	CBL-3W-US	Power Cord for United States
	CBL-3W-EU	Power Cord for Europe
	CBL-3W-UK	Power Cord for United Kingdom
	CBL-3W-AU	Power Cord for Australia and China
	CBL-3W-IL	Power Cord for Israel

¹³ Power cords for other countries are also available, if you need a power cord for a country not listed in the table please contact testsolutions@minicircuits.com.

Optional Accessories	Description
MUSB-CBL-3FR+	2.6 ft (0.8 m) USB Cable: USB type A(Male) to USB type Mini-B(Male) with ferrite
MUSB-CBL-7FR+ (spare)	6.6 ft (2.0 m) USB Cable: USB type A(Male) to USB type Mini-B(Male) with ferrite
CBL-RJ45-MM-5+	5 ft. network cable: RJ45(Male) to RJ45(Male) Cat 5E cable.

Calibration	Description
CALFX-30G-RC	Calibration Service Click Here

Additional Notes

- A. Performance and quality attributes and conditions not expressly stated in this specification document are intended to be excluded and do not form a part of this specification document.
- B. Electrical specifications and performance data contained in this specification document are based on Mini-Circuit's applicable established test performance criteria and measurement instructions.
- C. The parts covered by this specification document are subject to Mini-Circuits standard limited warranty and terms and conditions (collectively, "Standard Terms"); Purchasers of this part are entitled to the rights and benefits contained therein. For a full statement of the Standard Terms and the exclusive rights and remedies thereunder, please visit Mini-Circuits' website at www.minicircuits.com/MCLStore/terms.jsp