



LTCC SURFACE MOUNT

High Pass Filter

HFCG-650+

50Ω 730 to 6500 MHz

THE BIG DEAL

- Insertion Loss, 0.7 dB Typ.
- Stop Band Rejection, 47 dB Typ.
- Pass Band Return Loss, 11 dB Typ.
- 0805 Surface Mount Footprint
- Power Handling: 2 W



Generic photo used for illustration purposes only

APPLICATIONS

- Test & Measurement Equipment
- Radar, EW, and ECM Defense System
- 5G MIMO and Back Haul Radio
- 5G Sub 6 GHz and WiFi 6E

FUNCTIONAL DIAGRAM

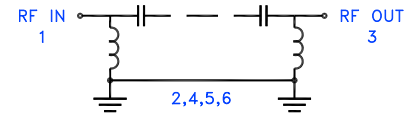

PRODUCT OVERVIEW

Mini-Circuits' HFCG-650+ is a miniature low temperature co-fired ceramic (LTCC) high pass filter with a 730 to 6500 MHz passband that supports a variety of applications. This model provides 0.7 dB typical insertion loss over a wide band due to its rugged monolithic construction. Housed in a tiny 0805 ceramic form factor which is ideal for dense signal chain PCB layouts where it complements MMIC size and performance. The LTCC fabrication process assures minimal RF performance variation while delivering a product that is well suited for environmental extremes of high humidity and temperature.

KEY FEATURES

| Features | Advantages |
|----------------------------|--|
| Wide passband, 5.77 GHz | This filter has a very wide passband from, 730 to 6500 MHz. |
| LTCC Construction | The use of LTCC technology allows for repeatable performance in a rugged ceramic package, well suited for tough environments such as high humidity and temperature extremes. See Mini-Circuits Environmental Rating ENV06T11 for more information. |
| Small Size, 0805 | 0805 package allows for space to be saved in dense circuit board layouts, while also minimizing the effects of parasitics |
| Rugged Power Handling, 2 W | Handles up to 2 Watts in a small 0805 package. |

REV. OR
ECO-019931
HFCG-650+
EDU4565
URJ
231213





ELECTRICAL SPECIFICATIONS^{1,2,3} AT +25°C

| Parameter | | F# | Frequency (MHz) | Min. | Typ. | Max. | Units |
|-----------|----------------------------|-------|-----------------|------|------|------|-------|
| Passband | Insertion Loss | F3-F4 | 730 - 1800 | — | 3.1 | — | dB |
| | | F4-F5 | 1800 - 5000 | — | 0.7 | 1.3 | |
| | | F5-F6 | 5000 - 6500 | — | 0.8 | 1.5 | |
| | Return Loss | F3-F4 | 730 - 1800 | — | 7 | — | dB |
| | | F4-F5 | 1800 - 5000 | — | 11 | — | |
| | | F5-F6 | 5000 - 6500 | — | 11 | — | |
| Stopband | Rejection | DC-F1 | DC - 390 | 39 | 47 | — | dB |
| | | F1-F2 | 390 - 490 | 20 | 35 | — | |
| | Freq. Cut-Off ⁴ | Fc | 650 | — | 3 | — | |

1. Tested on Evaluation Board P/N TB-HFCG-650+.
2. Bi-directional RF1 and RF2 ports can be interchanged.
3. This component should not be used as a DC-block. In applications where DC voltage and/or current is present at either the input or output ports, external DC blocking capacitors are required.
4. Typical variation ±5%.

ABSOLUTE MAXIMUM RATINGS⁵

| Parameter | Ratings |
|--------------------------|-----------------|
| Operating Temperature | -55°C to +125°C |
| Storage Temperature | -55°C to +125°C |
| Input Power ⁶ | 2 W @ +25°C |

5. Permanent damage may occur if any of these limits are exceeded.
6. Power rating applies only to signals within the passband. Power rating above +25°C operating temperature decreases linearly to 0.5 W at +125°C.

TYPICAL FREQUENCY RESPONSE AT +25°C

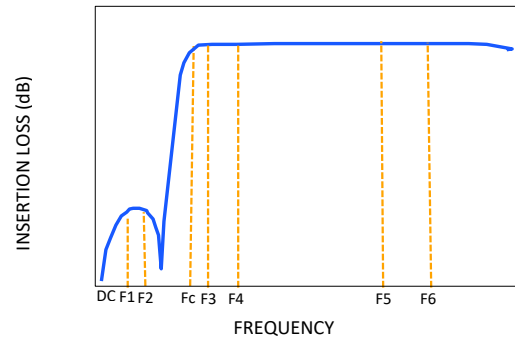



LTCC SURFACE MOUNT

High Pass Filter

HFCG-650+

Mini-Circuits

50Ω 730 to 6500 MHz

TYPICAL PERFORMANCE GRAPHS

HFCG-650+
INSERTION LOSS

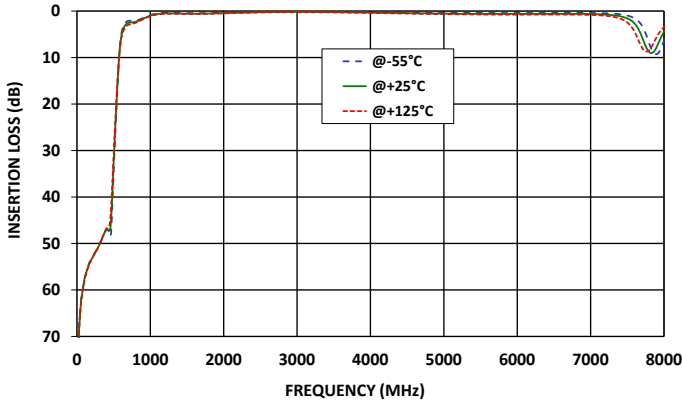

HFCG-650+
INSERTION LOSS (Zoomed)

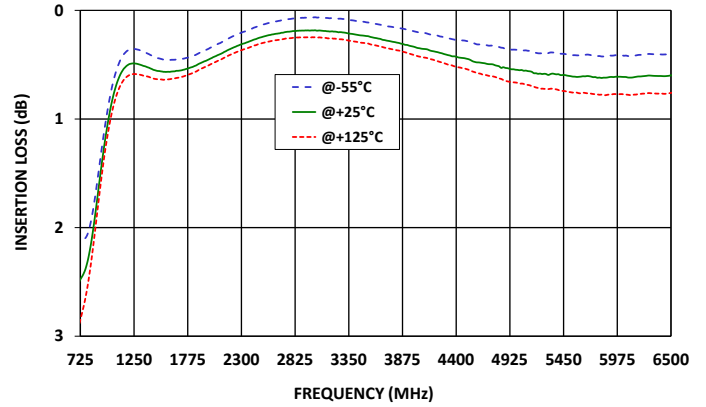

HFCG-650+
RETURN LOSS

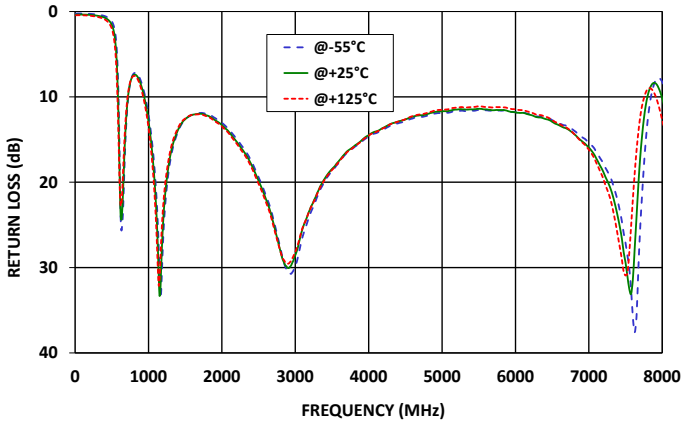

HFCG-650+
RETURN LOSS (Zoomed)

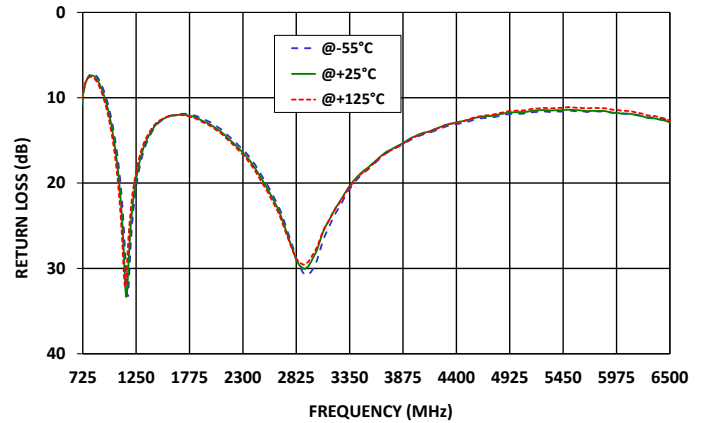

HFCG-650+
GROUP DELAY

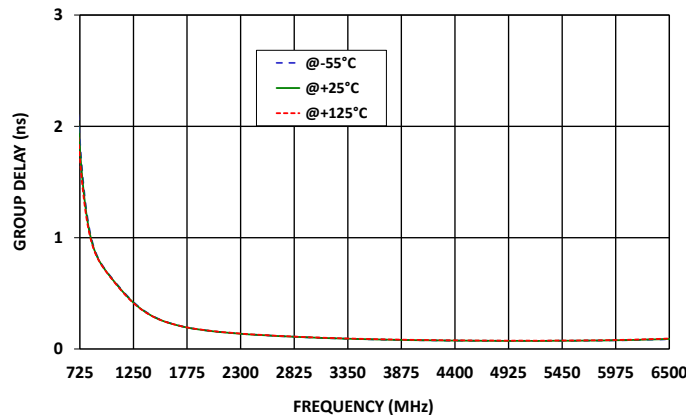



FUNCTIONAL DIAGRAM

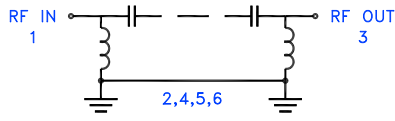
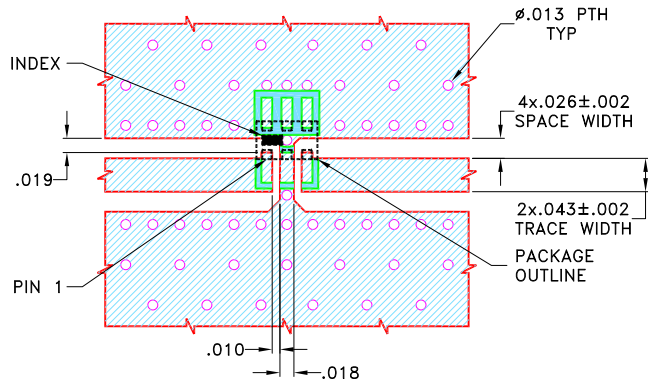

Figure 1. HFCG-650+ Functional Diagram

PAD DESCRIPTION

| Function | Pad Number | Description |
|------------------|------------|---|
| RF1 ² | 1 | Connects to RF Input Port |
| RF2 ² | 3 | Connects to RF Output Port |
| GROUND | 2,4,5,6 | Connects to Ground on PCB, (See drawing PL-633) |

SUGGESTED PCB LAYOUT (PL-633)



NOTES:

1. COPLANAR WAVEGUIDE PARAMETERS ARE SHOWN FOR ROGERS (R04350B) WITH DIELECTRIC THICKNESS .020±.0015. COPPER: 1/2 Oz. EACH SIDE. FOR OTHER MATERIALS TRACE WIDTH AND GAP MAY NEED TO BE MODIFIED.
 2. BOTTOM SIDE OF THE PCB IS CONTINUOUS GROUND PLANE.
- DENOTES PCB COPPER PATTERN WITH SMOBC (SOLDER MASK OVER BARE COPPER)
 ■ DENOTES PCB COPPER PATTERN FREE OF SOLDERMASK

Figure 2. Suggested PCB Layout PL-633

CASE STYLE DRAWING

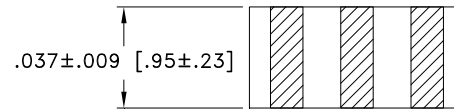
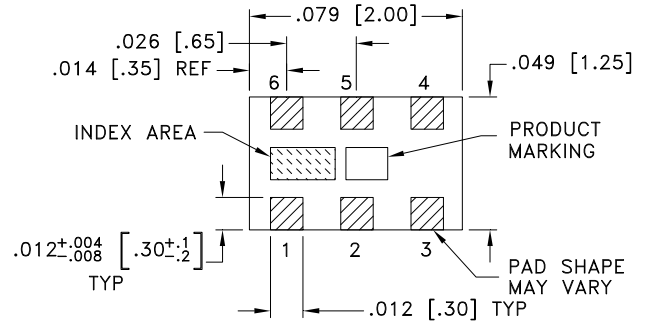

Weight: .008 grams.

Dimensions are in inches (mm). Tolerances: 2Pl. ± .01; 3 Pl. ± .005

PRODUCT MARKING*: XY

*Marking may contain other features or characters for internal lot control.



LTCC SURFACE MOUNT

High Pass Filter

HFCG-650+

Mini-Circuits

50Ω 730 to 6500MHz

ADDITIONAL DETAILED INFORMATION IS AVAILABLE ON OUR DASH BOARD.

[CLICK HERE](#)

| | |
|---------------------------------|---|
| Performance Data and Graphs | Data |
| | Graphs |
| | S-Parameter (S2P Files) Data Set (.zip file) De-embedded to device pads |
| Case Style | GE0805C-9 Lead Finish: Tin over Nickel Plating. |
| RoHS Status | Compliant |
| Tape and Reel | F114 |
| Suggested Layout for PCB Design | PL-633 |
| Evaluation Board | TB-HFCG-650+ |
| | Gerber File |
| Environmental Rating | ENV06T11 |

NOTES

- A. Performance and quality attributes and conditions not expressly stated in this specification document are intended to be excluded and do not form a part of this specification document.
- B. Electrical specifications and performance data contained in this specification document are based on Mini-Circuits' applicable established test performance criteria and measurement instructions.
- C. The parts covered by this specification document are subject to Mini-Circuits' standard limited warranty and terms and conditions (collectively, "Standard Terms"); Purchasers of this part are entitled to the rights and benefits contained therein. For a full statement of the standard terms and the exclusive rights and remedies thereunder, please visit Mini-Circuits' website at www.minicircuits.com/terms/viewterm.html

