



## STRIPLINE SURFACE MOUNT

# 2 Way 90° Power Splitter

# QCH-272+

50Ω 2 Way-90° 700 to 2700 MHz 200W

### KEY FEATURES

- High power handling, up to 200W
- Wide bandwidth
- Excellent Amplitude Unbalance,  $\pm 0.1$ dB

### APPLICATIONS

- Balanced Amplifiers
- I & Q Modulators
- Defense and Military



Generic photo used for illustration purposes only

### FUNCTIONAL DIAGRAM

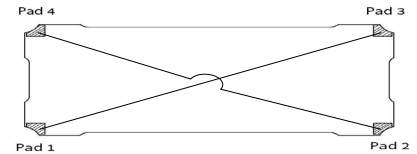

### PRODUCT OVERVIEW

Mini-Circuits new 2-way 90° power splitter, QCH-272+ capable of handling up to 200W with amplitude unbalance of  $\pm 0.1$  dB typ and phase unbalance of  $\pm 0.9$  deg. typ. Operating over a frequency range of 700 to 2700 MHz, the outstanding phase and amplitude unbalance make this component a versatile building block for use in a variety of systems and sub-system designs from balanced amplifiers and antenna feeds to military applications and more. The splitter is fabricated using laminated PCB process (1.8 x 0.4 x 0.19") and includes wrap-around terminations for good solderability and easy visual inspection.

### ELECTRICAL SPECIFICATIONS<sup>1,2</sup> AT +25°C

Parameter	Frequency (MHz)	Min.	Typ.	Max.	Units
Frequency Range		700		2700	MHz
Insertion Loss <sup>3</sup>	700-2700	-	0.3	0.5	dB
Isolation	700-2700	17	22	-	dB
Phase Unbalance	700-2700	-	$\pm 0.9$	$\pm 5$	deg
Amplitude Unbalance	700-2700	-	$\pm 0.1$	$\pm 1$	dB
	700-2700	-	$\pm 0.1$	$\pm 0.6$	
Return Loss	700-2700	16.5	23	-	dB
Thermal Resistance <sup>4</sup>	700-2700	-	0.3	-	°C/W

1. Tested on Evaluation Board TB-884+. De-embedded to the device reference plane.
2. Symmetrical all ports are interchangeable. See Pad Configuration Table and S-Parameters for actual performance.
3. Does not include theoretical loss due to coupling. Nominal theoretical loss is 3 dB.
4. Thermal Resistance is defined as, example  $(\theta_{jc} = (\text{Hot Spot Temperature on DUT} - \text{Base Plate Temperature}) / \text{Input Power})$

### ABSOLUTE MAXIMUM RATINGS<sup>5</sup>

Operating Case Temperature <sup>6</sup>		-55 °C to +105 °C
Storage Temperature		-55 °C to +105 °C
Power Input	+85 °C case	200 W
	+95 °C case	170 W
	+105 °C case	140 W

5. Permanent damage may occur if any of these limits are exceeded.
6. Case temperature is defined as temperature on base plate.





# STRIPLINE SURFACE MOUNT

# 2 Way 90° Power Splitter

# QCH-272+

Mini-Circuits

50Ω 2 Way-90° 700 to 2700 MHz 200W

## TYPICAL PERFORMANCE GRAPHS

Note : Data corresponds to Configuration A at +25°C unless specified otherwise.

QCH-272+  
Total Loss (dB)

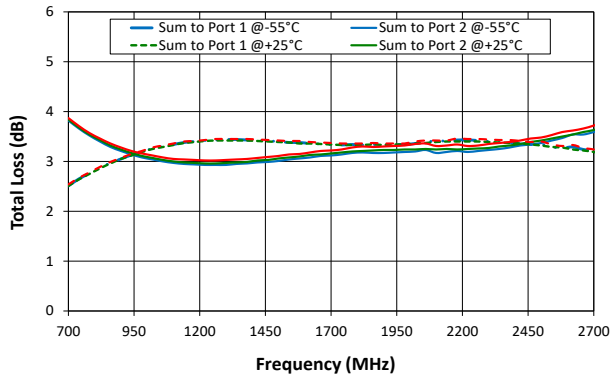

QCH-272+  
Isolation (dB)

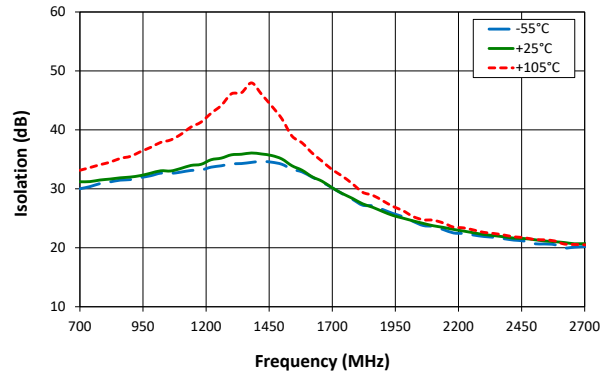

QCH-272+  
Amplitude & Phase Unbalance

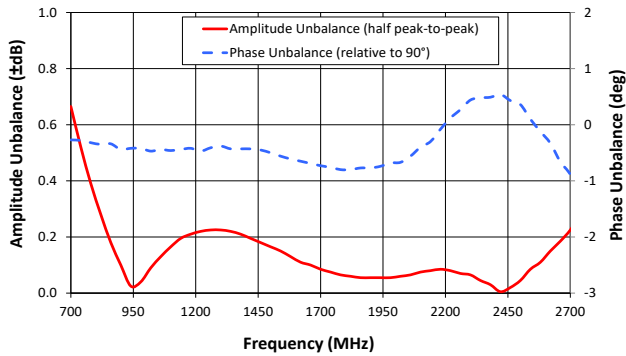

QCH-272+  
Return Loss (dB)

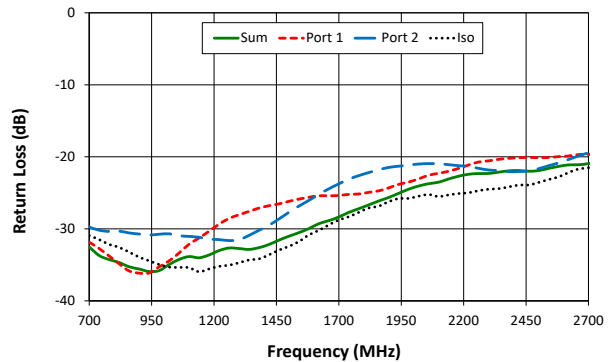



## STRIPLINE SURFACE MOUNT

# 2 Way 90° Power Splitter

# QCH-272+

50Ω 2 Way-90° 700 to 2700 MHz 200W

### FUNCTIONAL DIAGRAM

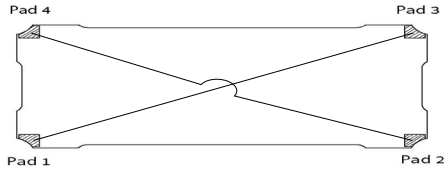

Figure 1. QCH-272+ Functional Diagram

### PAD DESCRIPTION/CONFIGURATION<sup>7</sup>

Function	Pad Number	Description
Input	1	Connects to RF Input Port
Output	2	Connects to RF Output Port
Coupled Forward	4	Connects to Coupled Forward Port
Coupled Reverse	3	Connects to Coupled Reverse Port
Ground	5	Connects to Ground

Configuration	Sum	Isolation	Port 1 (0°)	Port 2 (90°)
A	1	2	3	4
B	2	1	4	3
C	3	4	1	2
D	4	3	2	1

7. Model is symmetrical and all ports are interchangeable, see Port Function Description/Configuration table for details and S-Parameters for actual performance.

### SUGGESTED PCB LAYOUT (PL-480)

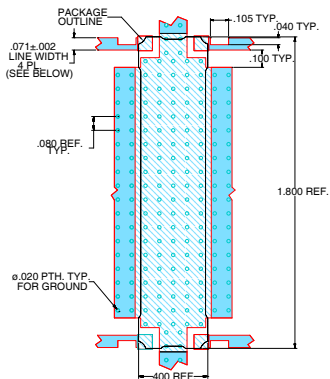

- NOTES:
- TRACE WIDTH IS SHOWN FOR ROGERS RO4003C WITH DIELECTRIC THICKNESS 0.032"±.0015", COPPER: 1 OZ. EACH SIDE. FOR OTHER MATERIALS TRACE WIDTH MAY NEED TO BE MODIFIED.
  - BOTTOM SIDE OF THE PCB IS CONTINUOUS GROUND PLANE.
  - CUTOUTS IN RF LINES ARE REQUIRED TO ACHIEVE SPECIFIED ISOLATION.
- 

Figure 2. Suggested PCB Layout PL-480

### CASE STYLE DRAWING (PQ2181)

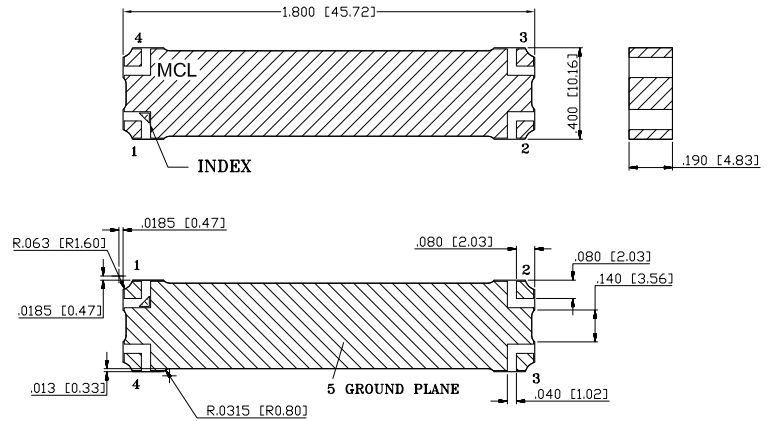

- NOTES:
- DIMENSIONS INCH [MM].
  - PIN NUMBERS DO NOT APPEAR ON UNIT, FOR REFERENCE ONLY.

- 

### PRODUCT MARKING\*: QCH-272+

\*Marking may contain other features or characters for internal lot control.



## STRIPLINE SURFACE MOUNT

# 2 Way 90° Power Splitter

## QCH-272+

50Ω 2 Way-90° 700 to 2700 MHz 200W

ADDITIONAL DETAILED INFORMATION IS AVAILABLE ON OUR DASH BOARD.

[CLICK HERE](#)

Performance Data & Graphs	Data
	Graphs S-Parameter (S4P Files) Data Set (.zip file) De-embedded to device pads
Case Style	PQ2181 Lead Finish: 2-5 inch (0.05-0.13 microns) Immersion Gold.
RoHS Status	Compliant
Tape and Reel	F120
Suggested Layout for PCB Design	PL-480
Evaluation Board	TB-884+
	Gerber File
Environmental Rating	ENV02T8

### NOTES

- A. Performance and quality attributes and conditions not expressly stated in this specification document are intended to be excluded and do not form a part of this specification document.
- B. Electrical specifications and performance data contained in this specification document are based on Mini-Circuits' applicable established test performance criteria and measurement instructions.
- C. The parts covered by this specification document are subject to Mini-Circuits' standard limited warranty and terms and conditions (collectively, "Standard Terms"); Purchasers of this part are entitled to the rights and benefits contained therein. For a full statement of the standard terms and the exclusive rights and remedies thereunder, please visit Mini-Circuits' website at [www.minicircuits.com/terms/viewterm.html](http://www.minicircuits.com/terms/viewterm.html)

