



USB

# Solid State SP2T Switch

## USB-1SP2T-34

50Ω 0.1 to 30 GHz

### THE BIG DEAL

- Super wide bandwidth, solid-state design
- High isolation, 50 dB @ 30 GHz
- USB control and automation
- Daisy-chain control of up to 25 switches

### APPLICATIONS

- RF signal routing / switch matrices
- Satellite communications up to Ka band
- Military radio, radar & electronic warfare
- Microwave radio / cellular infrastructure
- Test & measurement systems



Generic photo used for illustration purposes only

Model No.	USB-1SP2T-34
Case Style	NR3244
Connectors	2.92 mm (female) (Compatible with SMA and 3.5 mm)

DOWNLOAD

SOFTWARE PACKAGE

Refer to our website for compliance methodologies and qualifications

### PRODUCT OVERVIEW

Mini-Circuits' USB-1SP2T-34 is a fast switching solid-state SP2T covering an ultra-wide bandwidth, from 0.1 to 30 GHz. The solid-state design features an impressive combination of high isolation, low insertion loss and good linearity across the entire band. The switch is supplied in a low profile package with precision 2.92 mm RF connectors.

The daisy-chain control interface with "dynamic addressing" simplifies control integration, allowing multiple switches to be combined into a Master / Slave chain. Simply connect, then power on and the whole chain of up to 25 compatible switches can be controlled independently through a single USB and software interface.

Full software support is provided, including our user-friendly GUI application for Windows and a full API with programming instructions for Windows and Linux environments (both 32-bit and 64-bit systems).

### KEY FEATURES

Feature	Advantages
Fast switching sequences	Program automated switching sequences to run with extremely fast transitions and no external control.
High performance	Solid-state design combining high isolation with low insertion loss from 0.1 to 30 GHz
Dynamic daisy-chain control	Control up to 25 switches through a single USB interface.
USB control	USB HID interface provides easy compatibility with a wide range of software setups and programming environments
Full software support	User friendly Windows GUI (graphical user interface) allows manual control straight out of the box, while the comprehensive API (application programming interface) with examples and instructions allows easy automation in most programming environments

#### Trademarks:

Windows is a registered trademark of Microsoft Corporation in the United States and other countries ; Linux is a registered trademark of Linus Torvalds ; Pentium is a registered trademark of Intel Corporation. Neither Mini-Circuits nor the Mini-Circuits products are affiliated with or endorsed by the owners of the referenced trademarks. Mini-Circuits and the Mini-Circuits logo are registered trademarks of Scientific Components Corporation.



**USB**

# Solid State SP2T Switch

**USB-1SP2T-34****ELECTRICAL SPECIFICATIONS AT 0 TO 50°C**

Parameter	Ports	Condition (GHz)	Min.	Typ.	Max.	Unit
Frequency Range	-	-	0.1		30	GHz
Insertion Loss	COM to any active port	0.1 - 10	-	1.40	3.20	dB
		10 - 18	-	2.80	4.30	
		18 - 26	-	3.50	5.30	
		26 - 30	-	4.40	6.00	
Isolation	Between ports J1 & J2	0.1 - 10	50	70	-	dB
		10 - 18	50	60	-	
		18 - 26	45	55	-	
		26 - 30	45	55	-	
	COM to any terminated port (including disconnected state)	0.1 - 10	50	60	-	
		10 - 18	50	65	-	
		18 - 26	45	55	-	
		26 - 30	45	55	-	
Return Loss	COM port (in all active states)	0.1 - 10	-	21	-	dB
		10 - 18	-	15.5	-	
		18 - 26	-	14.5	-	
		26 - 30	-	12	-	
	Any port connected to COM	0.1 - 10	-	19	-	
		10 - 18	-	14.5	-	
		18 - 26	-	14	-	
		26 - 30	-	13	-	
	Any terminated port	0.1 - 10	-	19	-	
		10 - 18	-	16.5	-	
		18 - 26	-	13.5	-	
		26 - 30	-	12	-	
Power Input @1 dB Compression <sup>1</sup>	COM to any active port	0.1 - 30	-	27	-	dBm
IP3 <sup>2,3</sup>	COM to any active port	0.5 - 30	-	50	-	dBm
Transition Time <sup>4</sup>	-	-	-	5	20	ns
Minimum Dwell Time <sup>5</sup>	High-speed mode	-	-	10	-	µs
Switching Time (USB) <sup>6</sup>	-	-	-	2	-	ms
Supply Voltage (Vcc)	USB port	-	4.75	5	5.25	V <sub>DC</sub>
Supply Current (Icc) <sup>7</sup>		-	-	80	120	mA
Current Pass-through <sup>8</sup>	-	-	-	-	500	mA
Operating RF Input Power <sup>1</sup>	Between COM & active port	Hot switching	-	-	+18	dBm
	Between COM & active port	Cold switching	-	-	+24	
	Into any termination	-	-	-	+24	

1. Max power at hot switching derates linearly from +18 dBm @ 600 MHz to +17 dBm @100 MHz, at all other conditions it derates linearly from +24 dBm @ 600 MHz to +17 dBm @100 MHz.
2. IP3 may degrade below 500 MHz to about +45 dBm.
3. IP3 tested with 1 MHz span between signals, +8 dBm per tone.
4. Transition time spec represents the time that the RF signal paths are interrupted during switching and thus is specified without communication delays.
5. Minimum dwell time is the shortest time that can be achieved between 2 switch transitions when programming an automated switch sequence.
6. Switching time (USB) is the time from issuing a single software command via USB to the switch state changing. The most significant factor is the host PC, influenced by CPU load and USB protocol. The time shown is an estimate for a medium CPU load and USB 2.0 connection.
7. USB current draw for a single unit with no slave units.
8. Pass through current is the maximum supply current handling of a unit with slave modules attached. If controlling a large number of slave modules additional power supplies should be included to ensure this limit is not exceeded. See page 5 for details.





USB

# Solid State SP2T Switch

USB-1SP2T-34

## ABSOLUTE MAXIMUM RATINGS

Operating Temperature	0°C to 50°C
Storage Temperature	-20°C to 60°C
DC supply voltage max.	6V
DC voltage @ RF Ports	20 V

Permanent damage may occur if any of these limits are exceeded. Operating in the range between operating power limits and absolute maximum ratings for extended periods of time may result in reduced life and reliability.

## CONNECTIONS

Port Name	Connector Type
RF Ports (COM, 1 & 2)	2.92 mm female
USB	USB type-C receptacle
Serial In (Digital Control 2 port)	Digital Snap Fit Connector <sup>9</sup>
Serial Out (Digital Control 1 port)	Digital Snap Fit Connector <sup>9</sup>

9. Mating connector is Hirose ST40X-10S-CV(30).

## BLOCK DIAGRAM

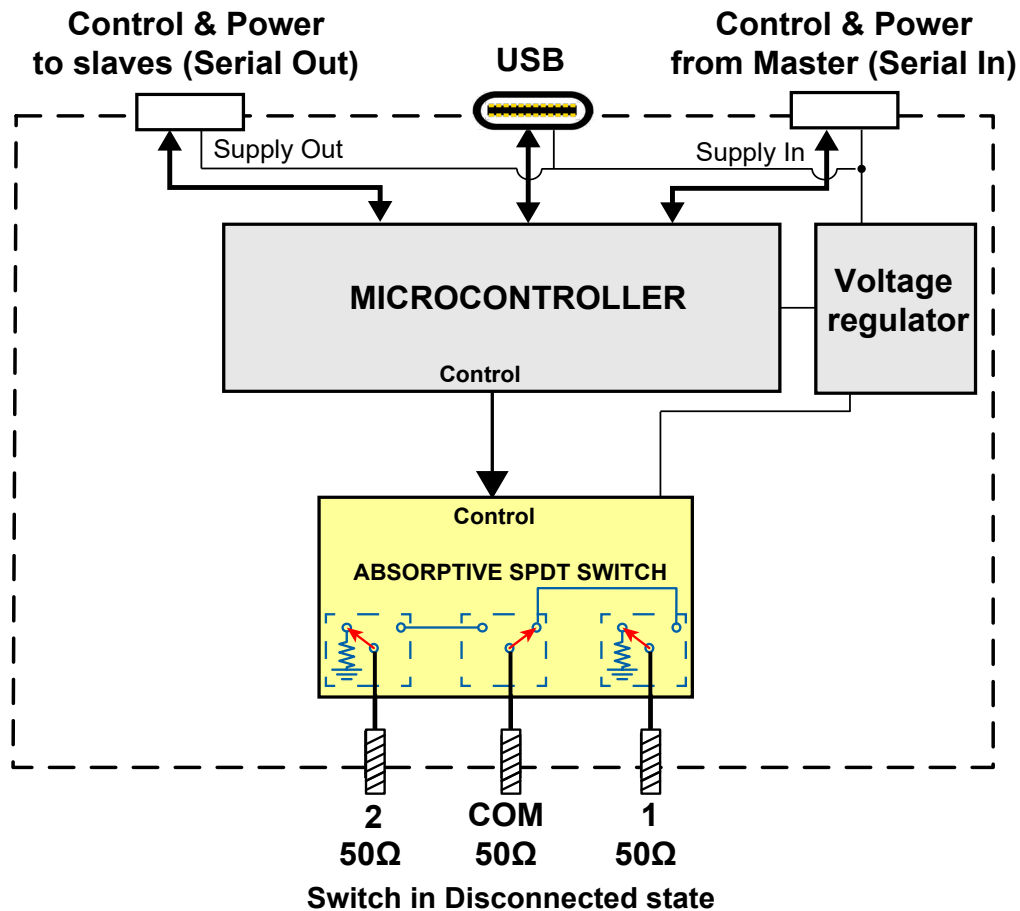



USB

# Solid State SP2T Switch

## USB-1SP2T-34

### OUTLINE DRAWING (NR3244)

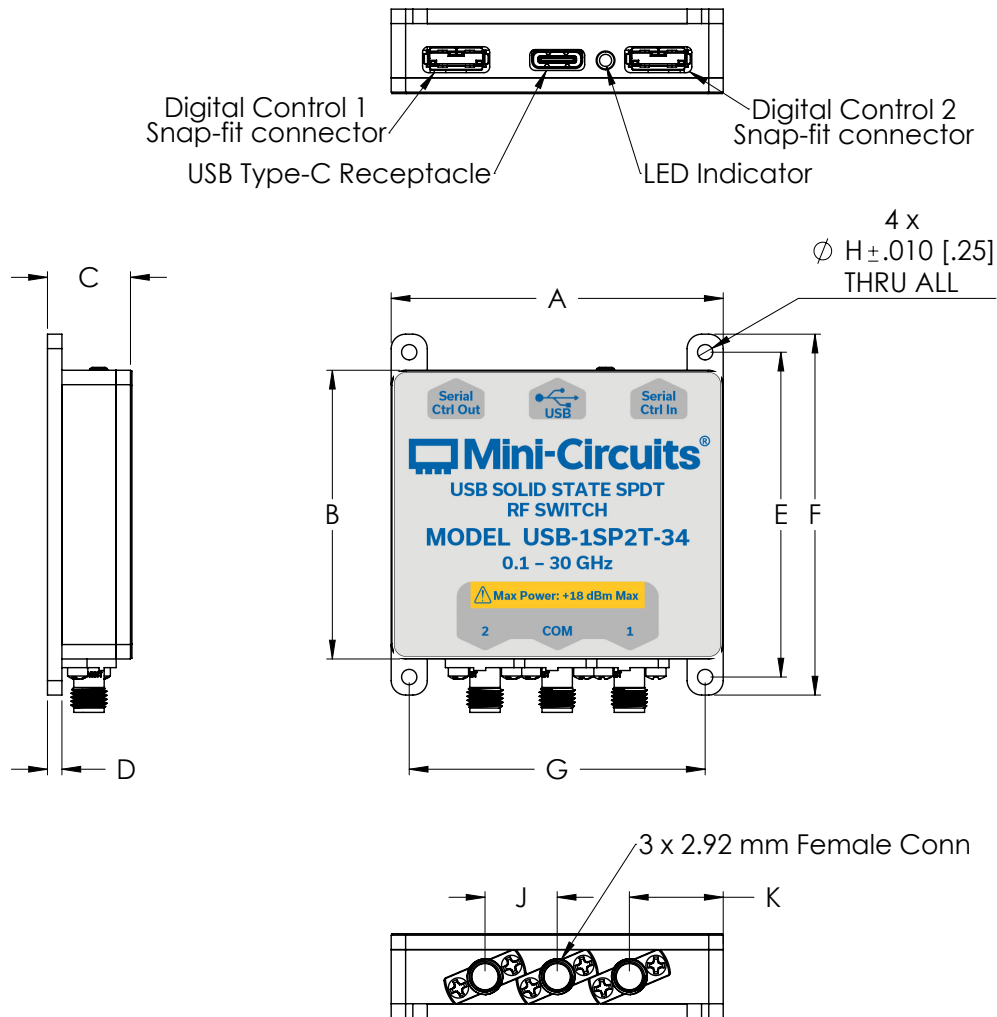

### OUTLINE DIMENSIONS ( INCH / mm )

A	B	C	D	E	F	G	H	J	K	weight
2.30	2.00	0.575	0.10	2.25	2.50	2.05	0.106	0.50	0.65	grams
58.42	50.80	14.610	2.54	57.15	63.50	52.07	2.690	12.70	16.51	100





### CONNECTING MULTIPLE MODULES (DAISY CHAIN)

The USB-1SP2T-34 model is designed to connect up to 25 modules in series (daisy chain) using dynamic addressing, meaning there is no need to specifically set the address of the modules. The addresses will be set automatically as part of establishing the communications with the computer. The module connected to the computer's USB port will be assigned address 0 (master), the first module connected to it will get address 1 (slave) and subsequent modules incrementing up to address 24 (slave).

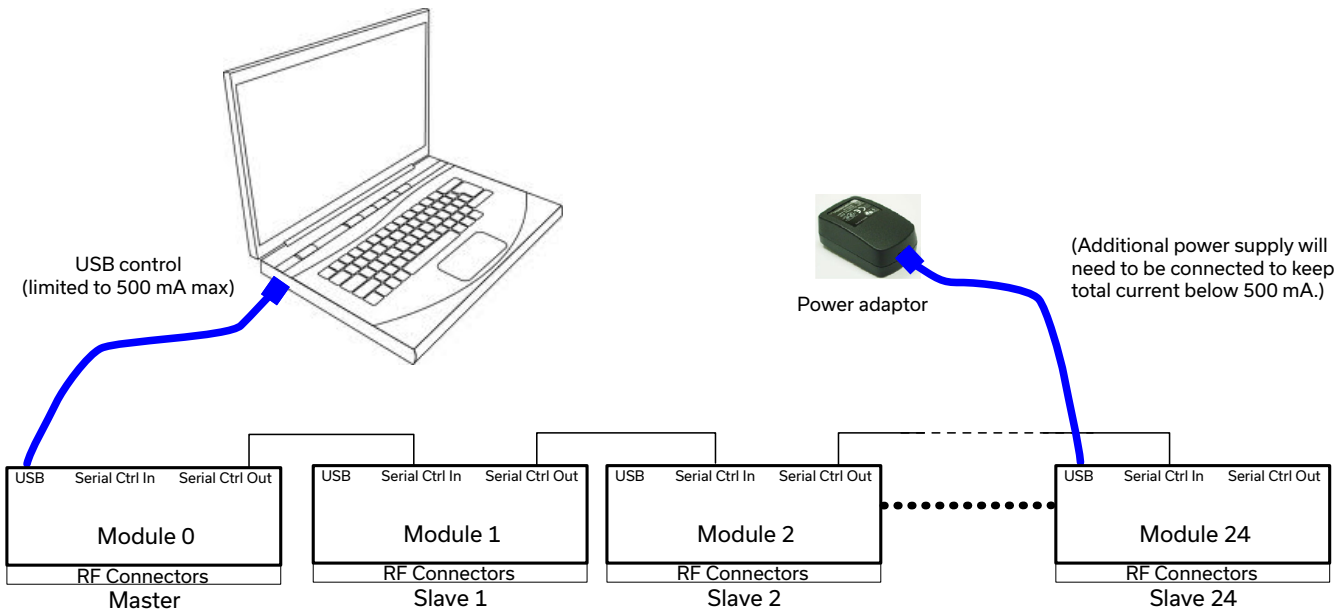

Connections between modules will be made using the serial in/out ports with the module connected to the PC act as a master and all other as slave modules. All control will be through the master module (address 0) which is the only one communicating with the PC. Serial control out port of each module should be connected to the serial control in port of the next module.

Power will be supplied from the PC via the master module up to a maximum of 500 mA. Generally, additional power supply will be needed to keep total current below 500 mA. All power supplies should be connected to the module via the module's USB port. Connecting an additional power supply will automatically cut off power draw from the serial control in port for that module.

The serial master/slave bus allows connecting modules of different types to the same daisy chain as long as all support Mini-Circuits Dynamic addressing setup. To add a new module to the setup, simply connect the module and refresh the address listing, no need to reset any of the existing modules or assign addresses manually.

**Note:** Different module types may have different current consumption which will change the number of units which can be connected before an additional power supply is needed.



USB

# Solid State SP2T Switch

USB-1SP2T-34

## TYPICAL PERFORMANCE CURVES

Insertion Loss over Temperature (J1 Active)

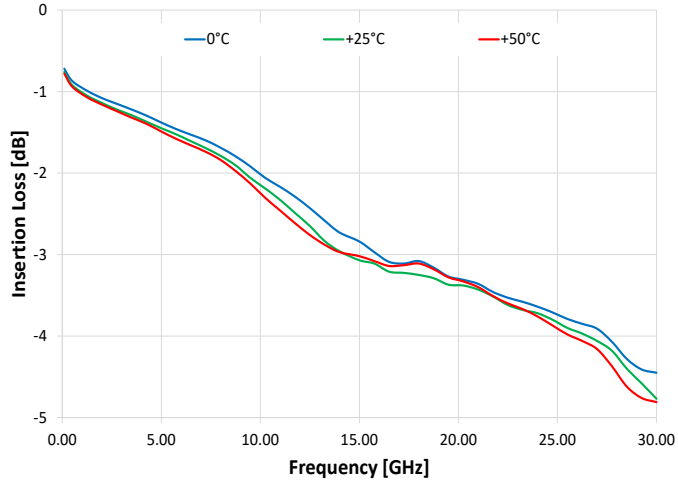

Insertion Loss J1 - J2 Active

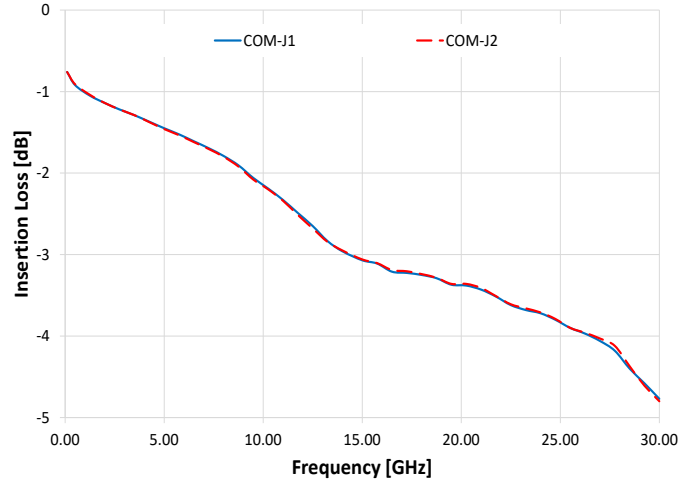

Isolation Com to J1 (J2 Active)

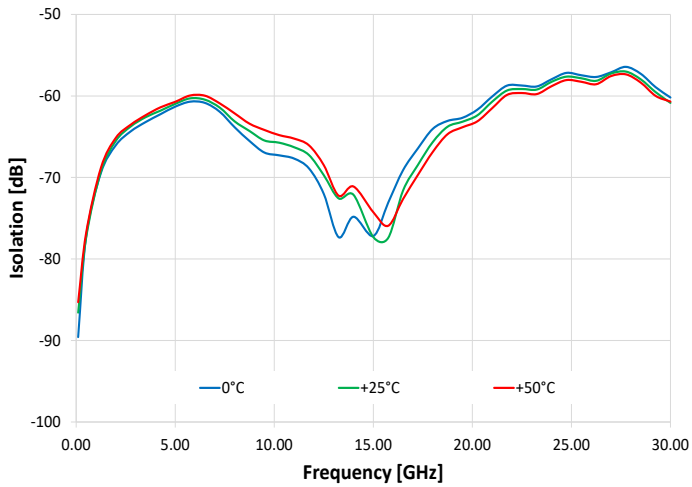

Isolation Com to J2 (J1 Active)

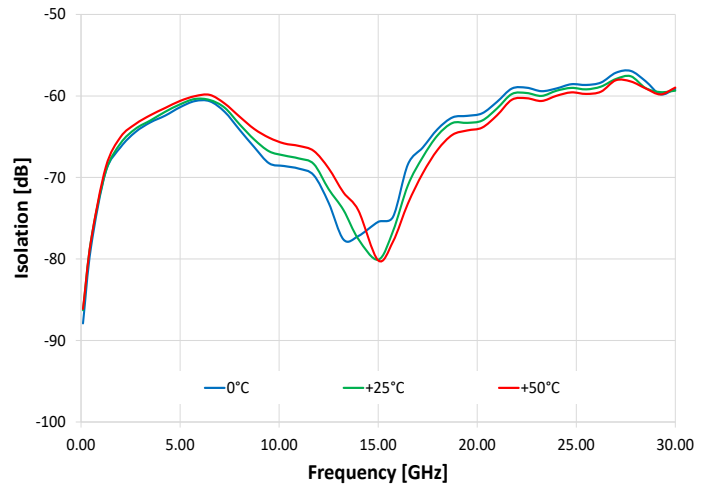

Isolation J1 to J2 (J1 Active)

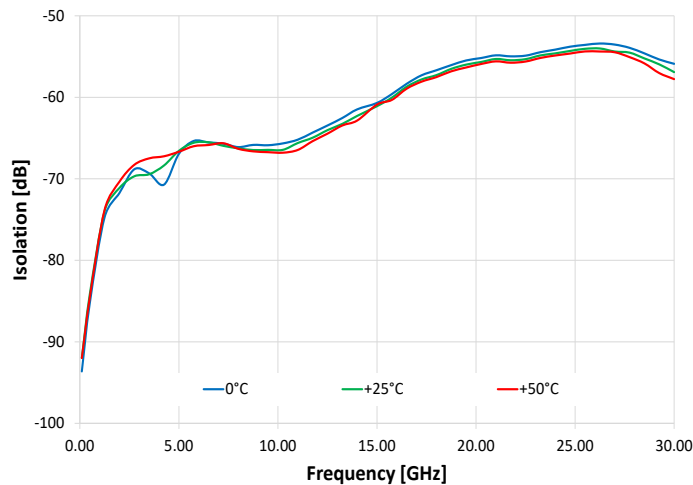



USB

# Solid State SP2T Switch

USB-1SP2T-34

## TYPICAL PERFORMANCE CURVES (CONTINUED)

Return Loss @ COM over Temperature (J1 Active)

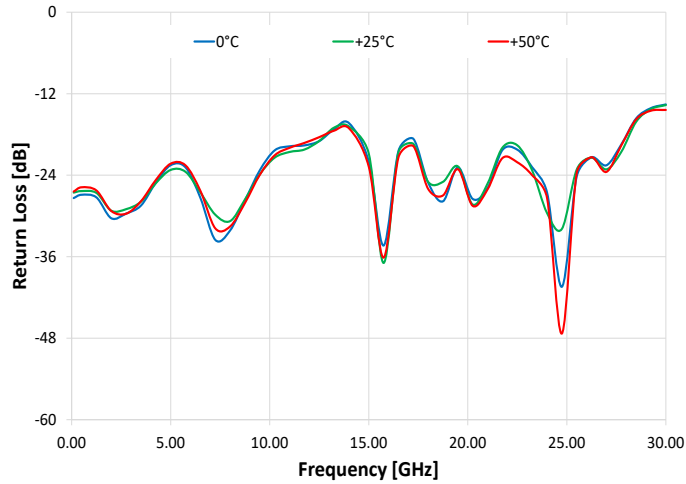

Return Loss @ J1 over Temperature (J1 Active)

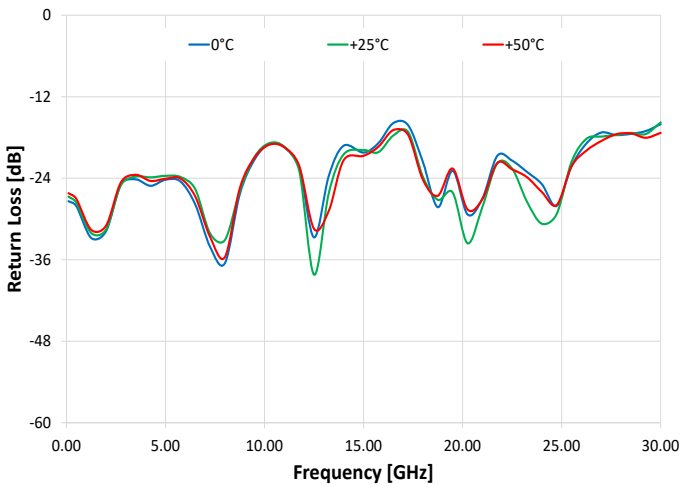

Return Loss @ J1 over Temperature (J1 Terminated)

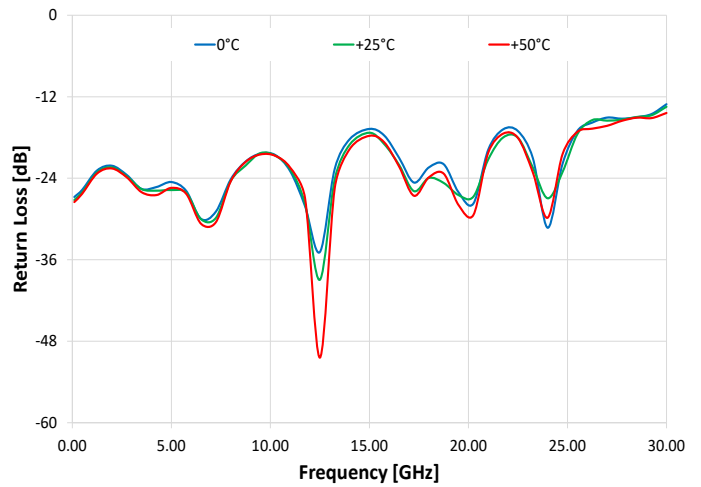

Return Loss @ J2 over Temperature (J2 Active)

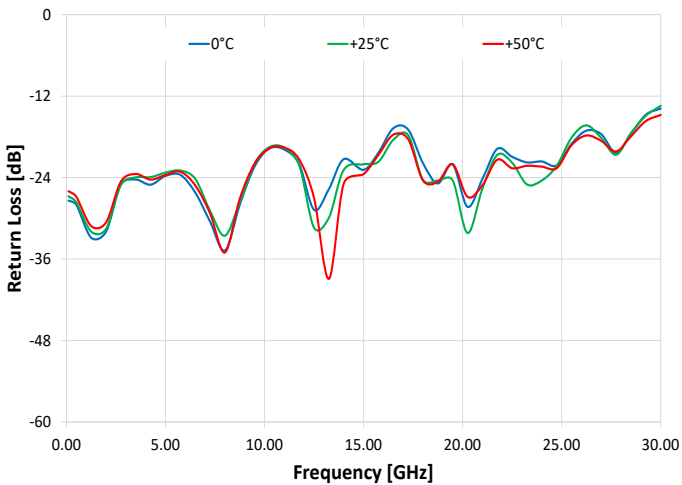

Return Loss @ J2 over Temperature (J2 Terminated)

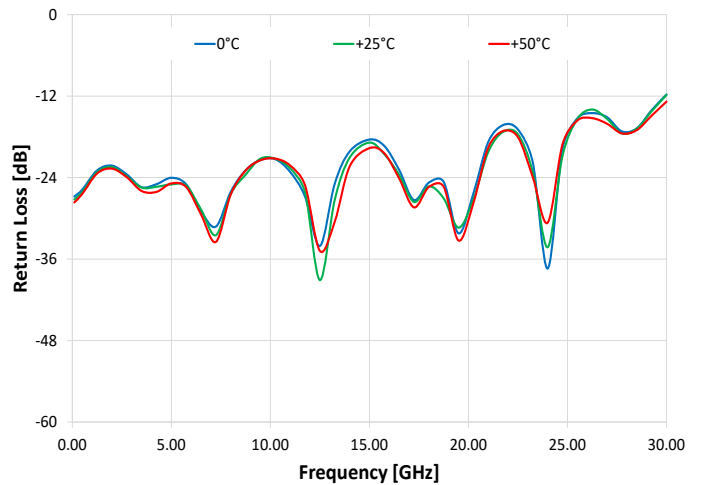



USB

# Solid State SP2T Switch

USB-1SP2T-34

Mini-Circuits

## SOFTWARE SPECIFICATIONS

### SOFTWARE & DOCUMENTATION DOWNLOAD:

- Mini-Circuits' full software and support package including user guide, Windows GUI, DLL files, programming manual and examples can be downloaded free of charge from: <https://www.minicircuits.com/softwaredownload/solidstate.html>
- Please contact [testsolutions@minicircuits.com](mailto:testsolutions@minicircuits.com) for support

### MINIMUM SYSTEM REQUIREMENTS:

Parameter	Requirements	
Interface	USB HID or Daisy-Chain dynamic addressing	
System Requirements	GUI	Windows 7 or later
	USB API DLL	Windows 7 or later and programming environment with ActiveX or .NET support
	USB Direct Programming	Linux, Windows 7 or later
	Daisy Chain dynamic addressing	An additional Mini-Circuits model supporting dynamic addressing
Hardware	Intel i3 (or equivalent) or later	

## APPLICATION PROGRAMMING INTERFACE (API)

### USB SUPPORT (WINDOWS):

- ActiveX COM DLL file for creation of 32-bit programs
- .NET library DLL file for creation of 32 / 64-bit programs
- Supported by most common programming environments

### USB SUPPORT (LINUX):

- Direct USB programming using a series of USB interrupt codes
- Full programming instructions and examples available for a wide range of programming environments / languages.





### GRAPHICAL USER INTERFACE (GUI) FOR WINDOWS - KEY FEATURES

- Connect via USB
- Run GUI in "demo mode" to evaluate software without a hardware connection

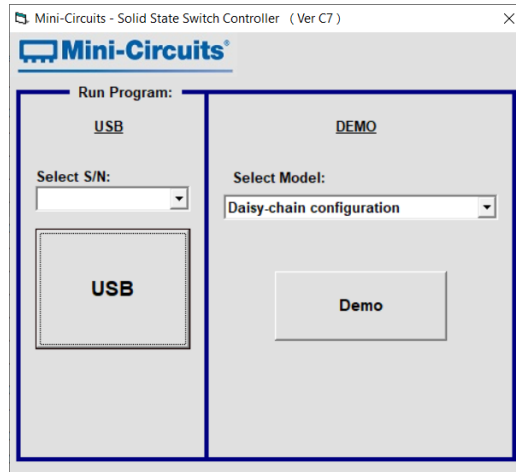

- View and set switch states at the click of a button
- Control up to 25 units from a single USB control
- Configure and run timed switching sequences
- Set start-up switch state

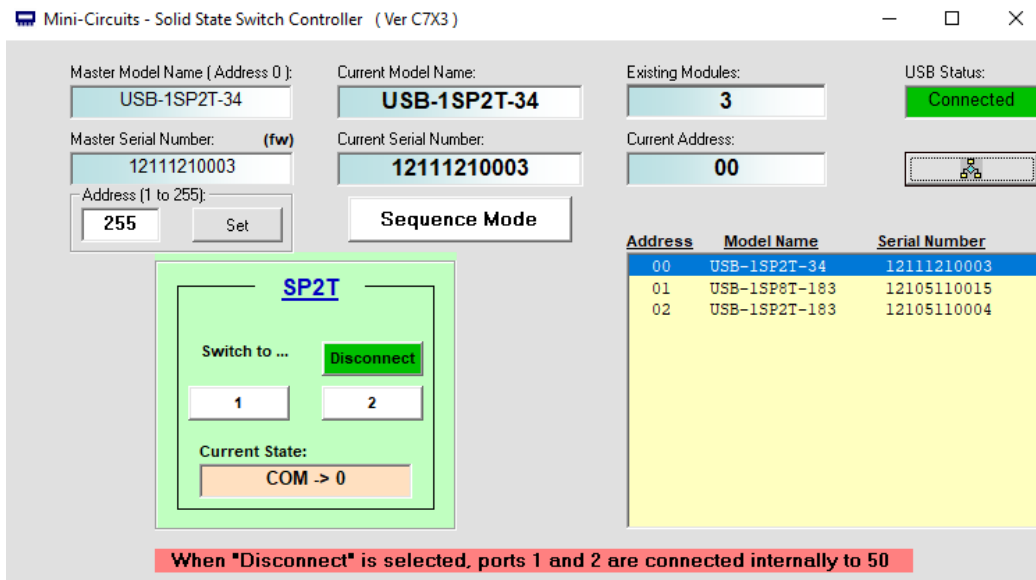



USB

# Solid State SP2T Switch

## USB-1SP2T-34

Mini-Circuits

### ORDERING INFORMATION

Please contact Mini-Circuits' Test Solutions department for price and availability: [testsolutions@minicircuits.com](mailto:testsolutions@minicircuits.com)

Model	Description
USB-1SP2T-34	USB RF SP2T switch

Included Accessories	Part No.	Description
	USB-CBL-AC-3+	3.3 ft (1.0 m) USB cable: USB type A (Male) to USB type C (Male)

### OPTIONAL ACCESSORIES

USB-CBL-AC-3+	3.3 ft (1.0 m) USB Cable: USB type A (Male) to USB type C (Male)
CBL-1.5FT-MMD+	1.5 ft (0.45 m) cable assembly for serial control Daisy Chain with snap fit connectors
USB-AC/DC-5	AC/DC +5V power adaptor with USB connector <sup>10, 11</sup>

10. The power adaptor may be used to provide additional power via USB port when connecting several units in daisy chain.

11. Includes power plugs for US, UK, EU, IL, AU & China. Plugs for other countries are also available. If you need a power cord for a country not listed please contact [testsolutions@minicircuits.com](mailto:testsolutions@minicircuits.com)

#### NOTES:

- A. Performance and quality attributes and conditions not expressly stated in this specification document are intended to be excluded and do not form a part of this specification document.
- B. Electrical specifications and performance data contained in this specification document are based on Mini-Circuit's applicable established test performance criteria and measurement instructions.
- C. The parts covered by this specification document are subject to Mini-Circuits standard limited warranty and terms and conditions (collectively, "Standard Terms"); Purchasers of this part are entitled to the rights and benefits contained therein. For a full statement of the Standard Terms and the exclusive rights and remedies thereunder, please visit Mini-Circuits' website at <https://www.minicircuits.com/terms/viewterm.html>

