

Coaxial

Power Detector

ZV47-K44+

50Ω -30 to +15 dBm 500 to 43500 MHz

The Big Deal

- Ultra-wideband, 500 MHz to 43.5 GHz
- Wide dynamic range of input power, -30 to +15 dBm
- Single positive supply voltage, +5V
- Low supply current: 3mA at +5V typical
- Fast output rise time: 4ns typical



CASE STYLE: AV2578-3

Product Overview

Mini-Circuits' ZV47-K44+ is an envelope detector that covers a wide RF input bandwidth from 500 MHz to 43.5 GHz. The output is a baseband voltage proportional to the instantaneous amplitude of the RF input signal, with power range from -30 to +15 dBm. It comes in a compact, gold over nickel plated brass alloy case (0.84 x 0.96 x 0.37") with 2.92mm RF connectors.

Key Features

Feature	Advantages
Ultra-wideband, 500 to 43500 MHz	Covers a wide range of applications including test and measurement, point-to-point microwave links and power control applications
Wide dynamic range of input power, -30 to +15 dBm	Can handle RF input signals with a wide range of amplitude variation.
Single supply voltage, +5V	Simplifies setup of power supply. Low power consumption with 3mA typical supply current draw.

Notes

- A. Performance and quality attributes and conditions not expressly stated in this specification document are intended to be excluded and do not form a part of this specification document.
B. Electrical specifications and performance data contained in this specification document are based on Mini-Circuit's applicable established test performance criteria and measurement instructions.
C. The parts covered by this specification document are subject to Mini-Circuits standard limited warranty and terms and conditions (collectively, "Standard Terms"); Purchasers of this part are entitled to the rights and benefits contained therein. For a full statement of the Standard Terms and the exclusive rights and remedies thereunder, please visit Mini-Circuits' website at www.minicircuits.com/MCLStore/terms.jsp



Coaxial Power Detector

ZV47-K44+

50Ω -30 to +15 dBm 500 to 43500 MHz

Maximum Ratings

Operating Temperature	-40°C to 85°C
Storage Temperature	-55°C to 100°C
DC Power:	
Max. voltage	5.5V
Input Power	+20dBm

Permanent damage may occur if any of these limits are exceeded.

Coaxial Connections

RF IN	1
DC OUT	4,6
Vcc (+5V)	2
GROUND	3,5

Outline Drawing

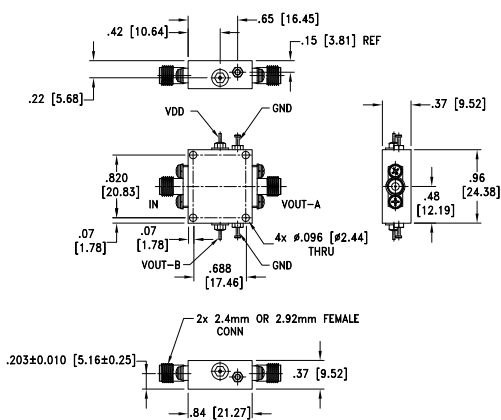

Weight: 48 grams
Dimensions are in inches (mm). Tolerances: 2 Pl. ±.02; 3 Pl. ±.010,

NOTE: When soldering the DC connections, caution must be used to avoid overheating the DC terminals. See Application Note [AN-40-10](#)

Simplified Functional Diagram

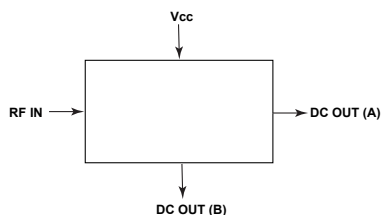

Features

- Ultra-wideband, 500 MHz to 43.5 GHz
- Wide dynamic range of input power, -30 to +15dBm
- Single positive supply voltage, +5V
- Low supply current: 3mA at +5V typical
- Fast output rise time: 4ns typical

Applications

- Point-to-Point Microwave Links
- Instrumentation and Measurement Equipment
- Military Radios
- LTE, WiFi, WiMAX Wireless Networks
- RMS Power Measurement
- Receive and Transmit Gain Control
- RF PA Transmit Power Control



Generic photo used for illustration purposes only

CASE STYLE: AV2578-3

Connectors	Model
2.92mm Fem	ZV47-K44+

+RoHS Compliant

The +Suffix identifies RoHS Compliance. See our web site for RoHS Compliance methodologies and qualifications

Electrical Specifications at 25°C

Parameter	Frequency (MHz)	Min.	Typ.	Max.	Units	
Frequency Range		500		43500	MHz	
Dynamic Range at ±1dB Error	500 - 43500		-30 to 15		dBm	
Output Voltage Range	500 - 43500		0 - 4.3		V	
VSWR	500 - 43500		2.4		(:1)	
Pulse Responsive Time	Rise	500 - 43500	4		ns	
	Fall	500 - 43500	50			
DC Operating Power	Vcc	500 - 43500	4.75	5.0	5.25	V
	Current	500 - 43500		3		mA

OUTPUT VOLTAGE vs. INPUT POWER @+25C

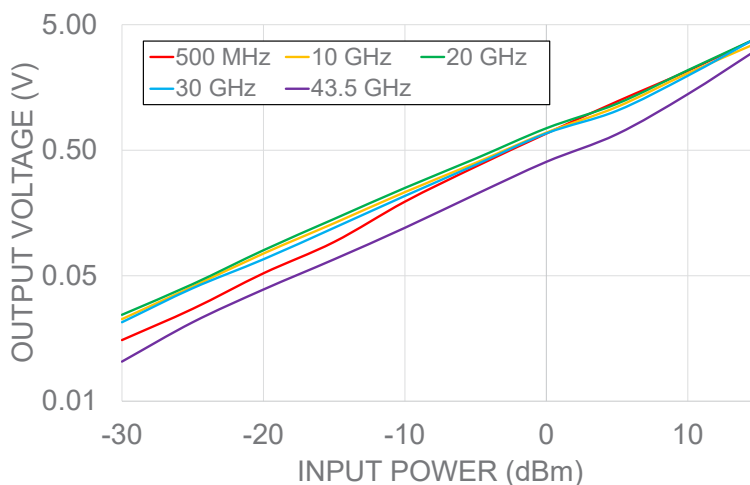

Notes

- Performance and quality attributes and conditions not expressly stated in this specification document are intended to be excluded and do not form a part of this specification document.
- Electrical specifications and performance data contained in this specification document are based on Mini-Circuit's applicable established test performance criteria and measurement instructions.
- The parts covered by this specification document are subject to Mini-Circuits standard limited warranty and terms and conditions (collectively, "Standard Terms"); Purchasers of this part are entitled to the rights and benefits contained therein. For a full statement of the Standard Terms and the exclusive rights and remedies thereunder, please visit Mini-Circuits' website at www.minicircuits.com/MCLStore/terms.jsp



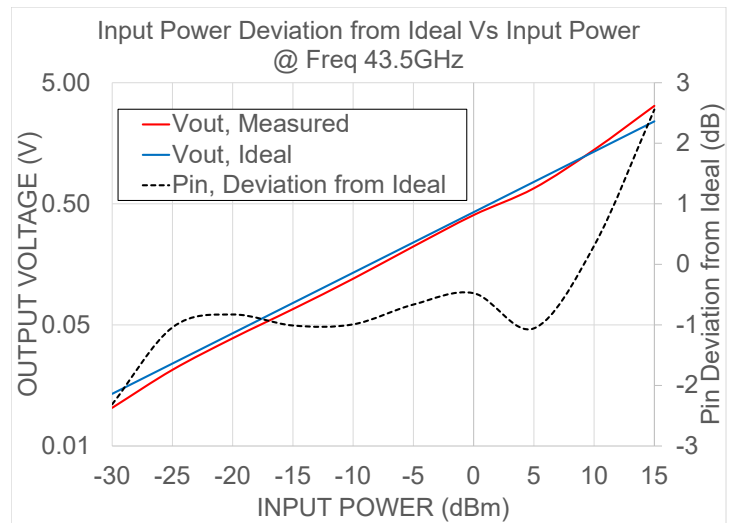
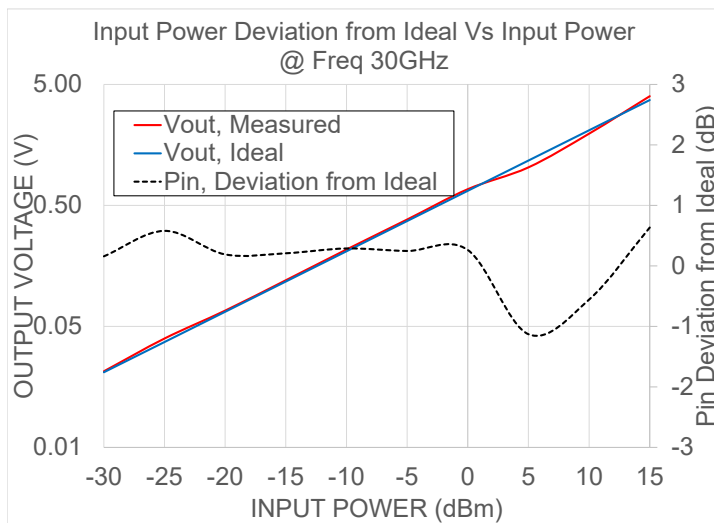
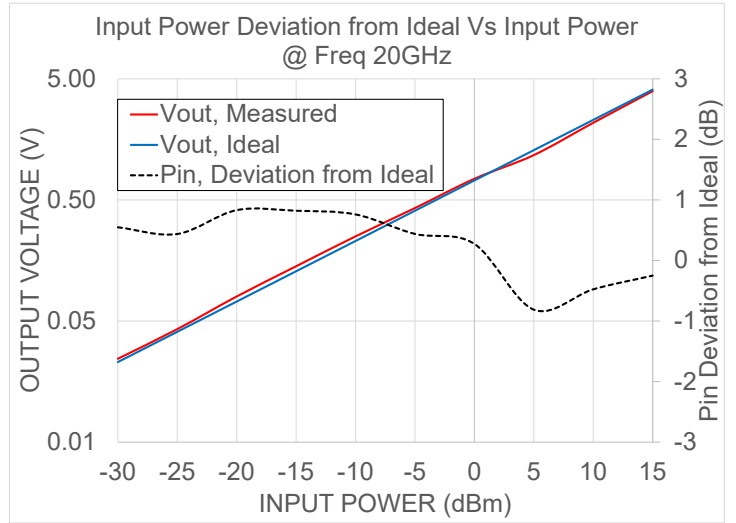
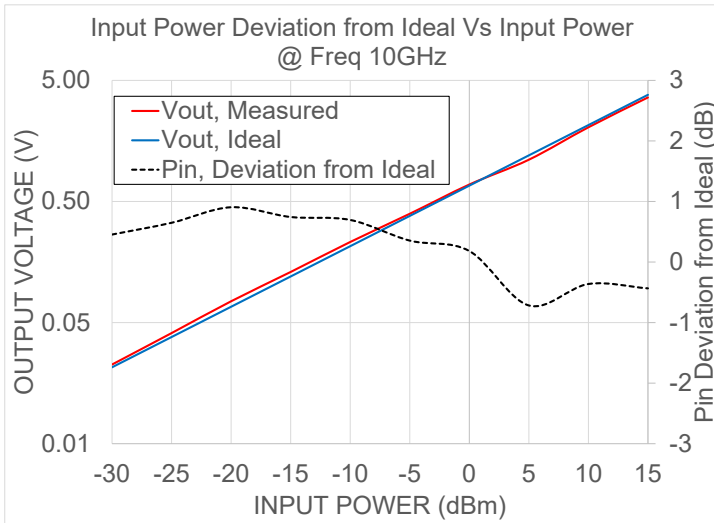
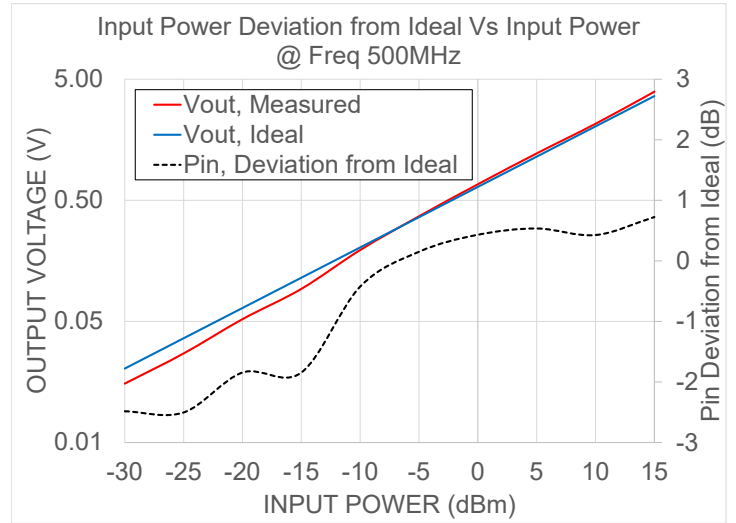
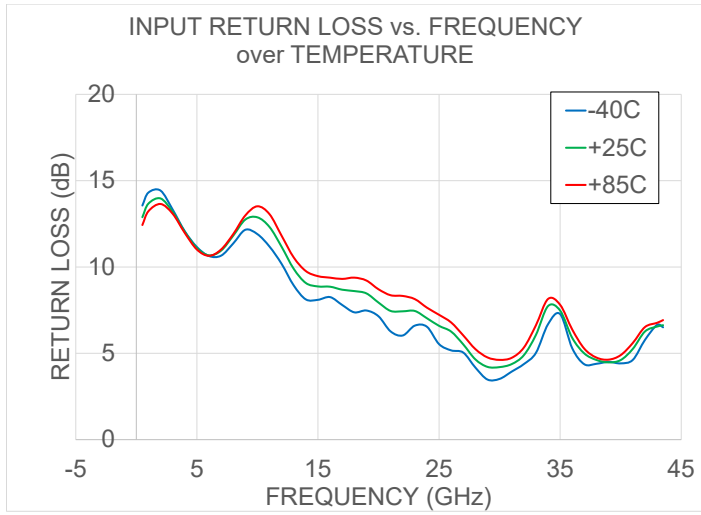

Notes

- A. Performance and quality attributes and conditions not expressly stated in this specification document are intended to be excluded and do not form a part of this specification document.
- B. Electrical specifications and performance data contained in this specification document are based on Mini-Circuit's applicable established test performance criteria and measurement instructions.
- C. The parts covered by this specification document are subject to Mini-Circuits standard limited warranty and terms and conditions (collectively, "Standard Terms"); Purchasers of this part are entitled to the rights and benefits contained therein. For a full statement of the Standard Terms and the exclusive rights and remedies thereunder, please visit Mini-Circuits' website at www.minicircuits.com/MCLStore/terms.jsp



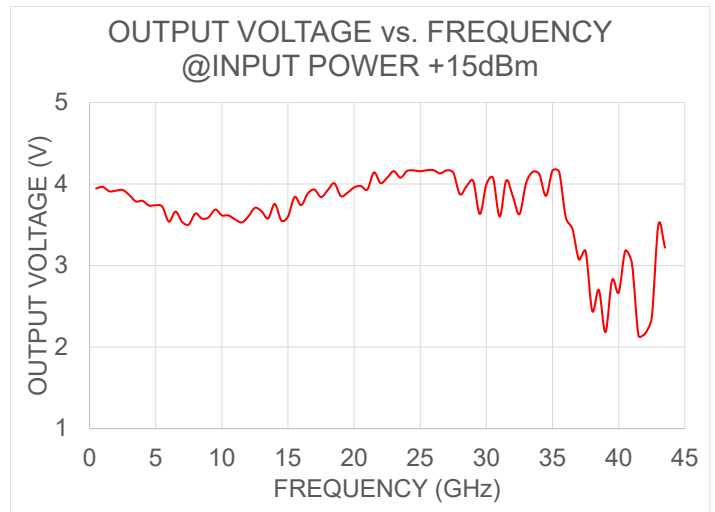
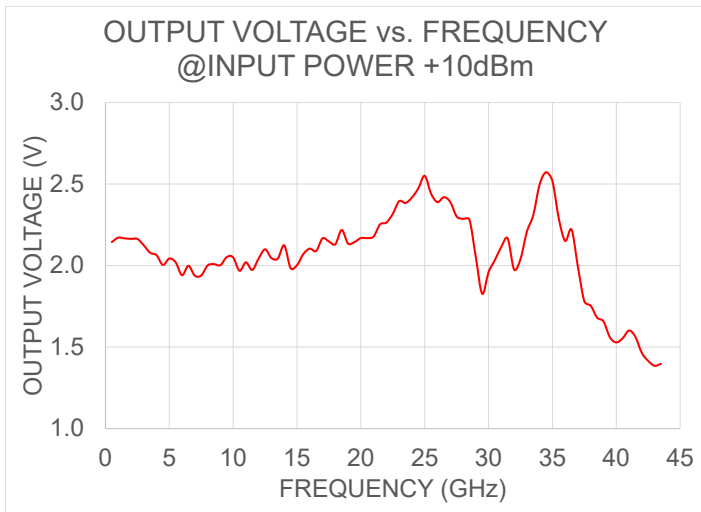
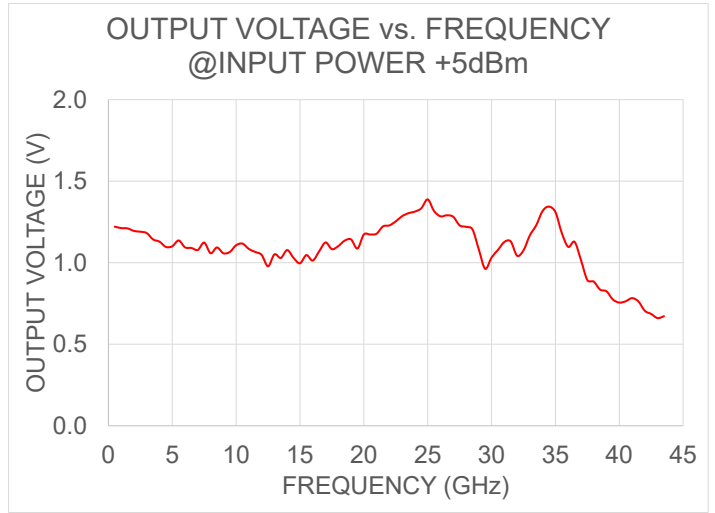
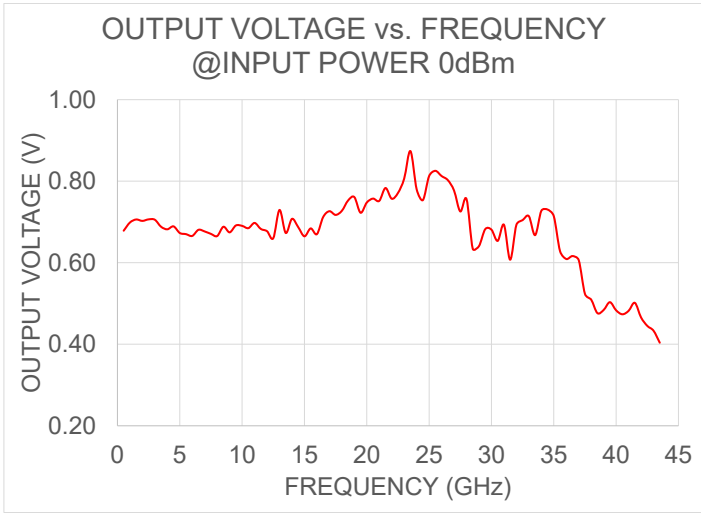
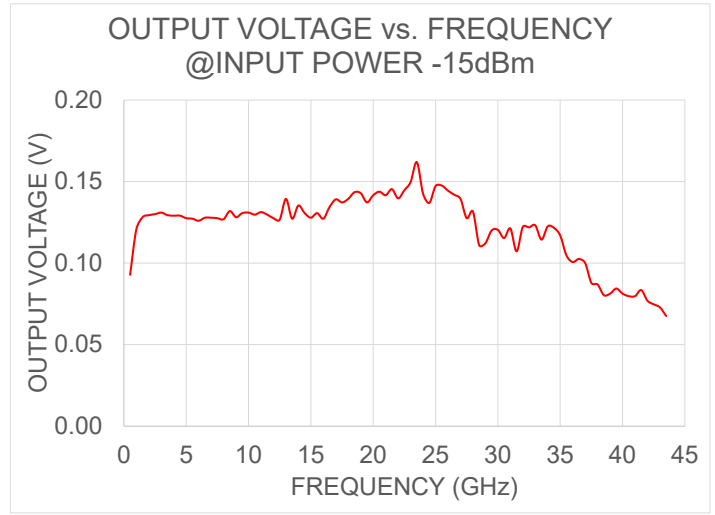
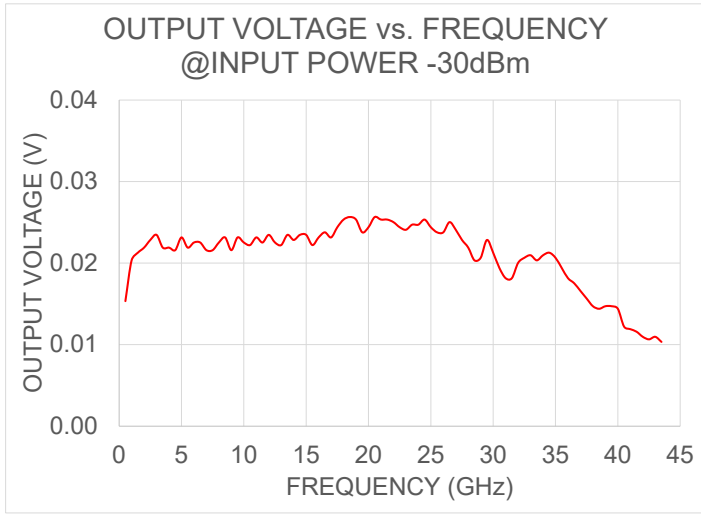

Notes

- A. Performance and quality attributes and conditions not expressly stated in this specification document are intended to be excluded and do not form a part of this specification document.
- B. Electrical specifications and performance data contained in this specification document are based on Mini-Circuit's applicable established test performance criteria and measurement instructions.
- C. The parts covered by this specification document are subject to Mini-Circuits standard limited warranty and terms and conditions (collectively, "Standard Terms"); Purchasers of this part are entitled to the rights and benefits contained therein. For a full statement of the Standard Terms and the exclusive rights and remedies thereunder, please visit Mini-Circuits' website at www.minicircuits.com/MCLStore/terms.jsp

