

Evaluation Board and Circuit

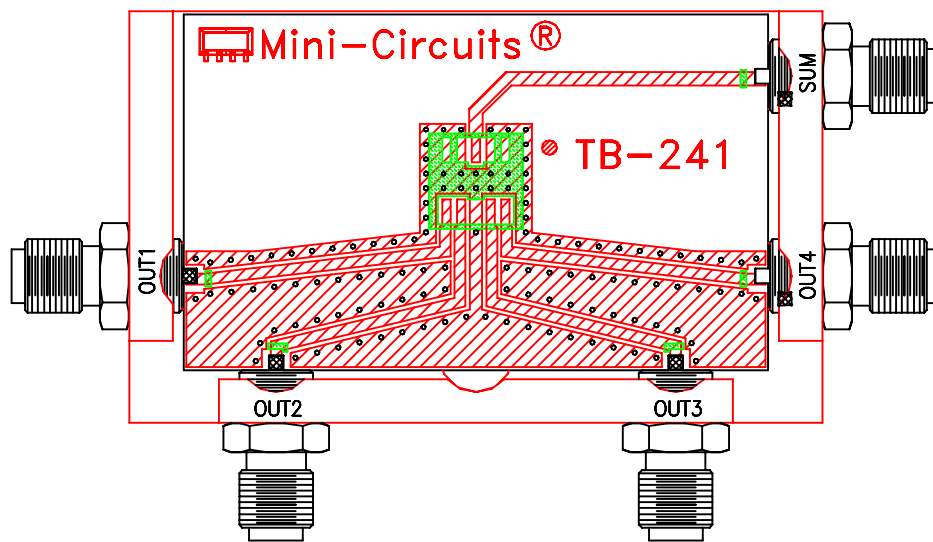

TB-241

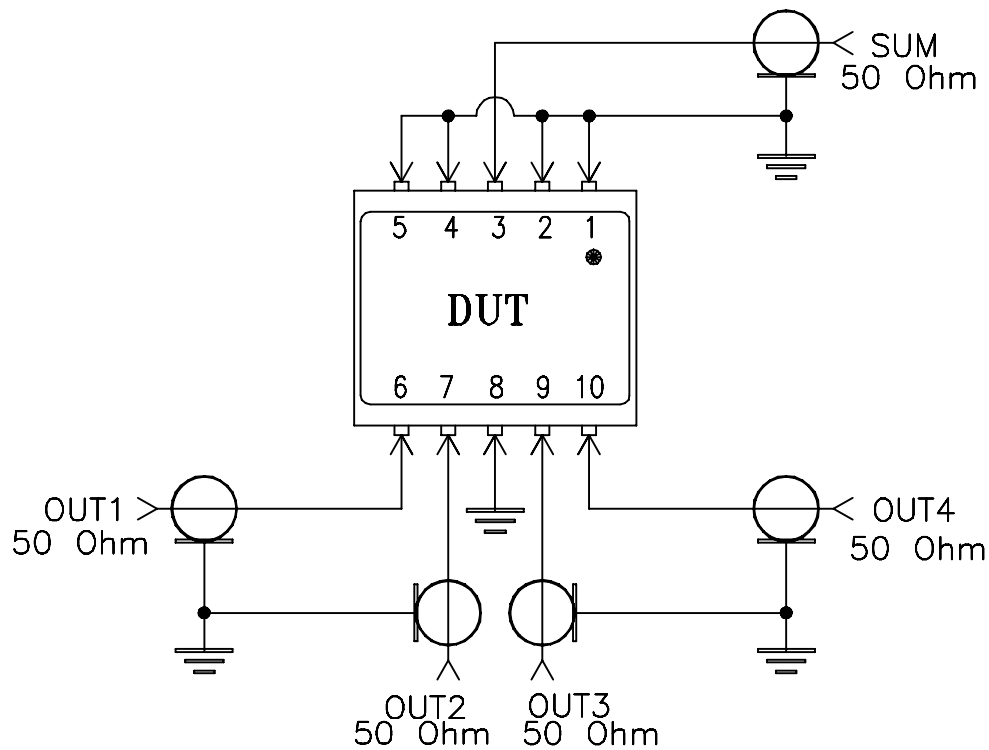

Schematic Diagram

Notes:

1. SMA Female connectors.
2. PCB Material: Rogers R04350 or equivalent, Dielectric Constant=3.5, Thickness=.020 inch.

 Mini-Circuits®