

Wideband, Microwave Monolithic Amplifier Die

AVA-24A-D+

50Ω 5 to 22 GHz

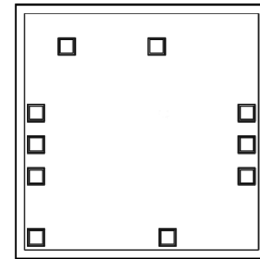

The Big Deal

- Ultra-wideband, 5 to 22 GHz
- Integrated matching, DC blocks, bias circuits
- Unpackaged die form

Product Overview

The AVA-24A-D+ is an ultra-wideband microwave amplifier die fabricated using InGaAs PHEMT technology operating over extremely wide frequency range from 5 to 22 GHz. This model integrates the entire matching network with the majority of the bias circuit, reducing the need for complicated external circuits and simplifying board layouts. These advantages make the AVA-24A-D+ extremely user friendly and enable simple, straightforward use.

Key Features

Feature	Advantages
Ultra-wideband, 5 to 22 GHz	Very broad frequency range supports a wide array of applications from microwave radio and radar to military communications and countermeasures, among others.
Excellent gain flatness, ± 1.3 dB	Minimizes the need for external equalizer networks and gain flattening components, making it a great fit for instrumentation and EW applications.
High isolation, 31 to 42 dB	With high reverse isolation (18 – 30 dB directivity), the AVA-24A-D+ is an excellent choice for buffering broadband circuits. It is an ideal LO driver amplifier and provides designers system flexibility and margin when integrating cascaded RF components.
Single +5V supply	<ul style="list-style-type: none">• No hassle associated with amplifiers using dual supply such as power supply sequencing.• Integrated output bias-tee simplifies layout and reduces cost.
Unpackaged die	Enables the user to integrate the amplifier directly into hybrids.

Wideband, Microwave Monolithic Amplifier Die

AVA-24A-D+

50Ω 5 to 22 GHz

Product Features

- Gain, 13.1 dB typ. & Flatness, ± 1.6 dB
- Output Power, up to +19.4 dBm typ.
- Excellent isolation, 37 dB typ. at 12 GHz
- Single Positive Supply Voltage, 5.0V
- Integrated DC blocks, Bias-Tee & Microwave bypass capacitor
- Unconditionally Stable

Typical Applications

- Military EW and Radar
- DBS
- Wideband Isolation amplifier
- Microwave point-to-point radios
- Satellite systems

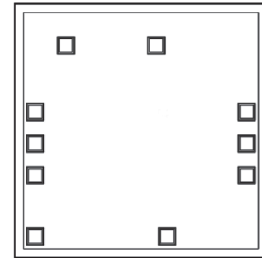

+RoHS Compliant

The +Suffix identifies RoHS Compliance. See our web site for RoHS Compliance methodologies and qualifications

Ordering Information: Refer to Last Page

General Description

The AVA-24A-D+ is a wideband monolithic amplifier die fabricated using InGaAs PHEMT technology with outstanding gain flatness up to 22 GHz. It is manufactured using PHEMT technology and is unconditionally stable. Its outstanding isolation enables it to be used as a wideband isolation amplifier or buffer amplifier in a variety of microwave systems.

Simplified Schematic and Pad description

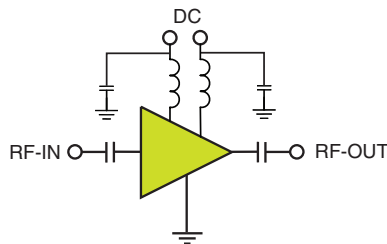

Function	Description
RF-IN	RF input pad
RF-OUT	RF output pad
DC (V_{D1} , V_{D2})	DC power supply
GND	Connected to ground

Note: 1. Bond Pad material - Gold
2. Bottom of Die - Gold plated

Electrical Specifications⁽¹⁾ at 25°C, Zo=50Ω, (refer to characterization circuit, Fig. 1)

Parameter	Condition (GHz)	Min.	Typ.	Max.	Units
Frequency Range		5.0		22.0	GHz
DC Voltage (V _{D1} , V _{D2})			5.0		V
DC Current (I _{D1} +I _{D2})		94	126	147	mA
Gain	5.0		11.4		dB
	8.0		13.9		
	10.0		13.4		
	12.0		13.0		
	14.0		12.9		
	16.0		13.7		
	22.0		10.6		
Input Return Loss	5.0		10.3		dB
	8.0		32.1		
	10.0		21.1		
	12.0		18.1		
	14.0		17.6		
	16.0		17.6		
Output Return Loss	5.0		6.4		dB
	8.0		12.0		
	10.0		10.7		
	12.0		9.9		
	14.0		10.0		
	16.0		10.4		
Output IP3 ⁽²⁾	5.0		32.6		dBm
	8.0		27.5		
	10.0		26.4		
	12.0		25.3		
	14.0		24.2		
	16.0		23.3		
Output Power @ 1 dB compression	5.0		16.9		dBm
	8.0		18.4		
	10.0		19.0		
	12.0		19.2		
	14.0		19.4		
	16.0		19.2		
Noise Figure	5.0		9.3		dB
	8.0		5.2		
	10.0		5.4		
	12.0		5.8		
	14.0		5.8		
	16.0		6.1		
22.0		6.4			
Directivity (Isolation-Gain)	12		24		dB
DC Current Variation vs. Voltage			0.002		mA/mV
Thermal Resistance			45		°C/W

Absolute Maximum Ratings⁽³⁾

Parameter	Ratings
Operating Temperature	-40°C to 85°C
Channel Temperature	150°C
DC Voltage V _{D1} , V _{D2} Pad ⁽⁴⁾	5.5 V
DC Voltage RF-IN & RF OUT	10 V
Power Dissipation	860 mW
DC Current V _{D1} & V _{D2} (Total)	160 mA
Input Power (CW)	20 dBm

1. Measured on Mini-Circuits Die Characterization test board

See Characterization Test Circuit (Fig. 1)

2. At Pout=8 dBm/100MHz

3. Permanent damage may occur if any of these limits are exceeded.

These maximum ratings are not intended for continuous normal operation.

Measured in industry standard 3x3 min 8-lead MCLP package

4. For continuous operation do not exceed 5.2V

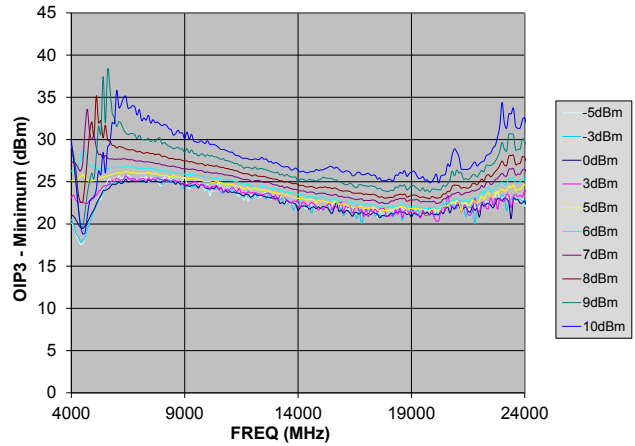
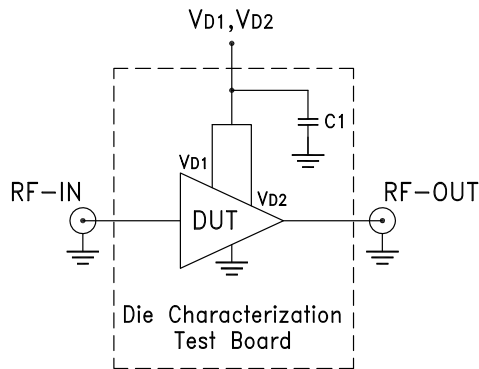

Figure 1: Test Circuit used for characterization. Gain, Return loss, Output power at 1dB compression (P1 dB), output IP3 (OIP3) and noise figure measured using Agilent’s N5242A PNA-X microwave network analyzer. C1=100 pF, Complex capacitor CSA-200-10X10X10X5-G-101-M

Conditions:

1. Gain and Return loss: Pin= -25dBm
2. Output IP3 (OIP3): Two tones, spaced 1 MHz apart, 8 dBm/tone at output.

Die Layout

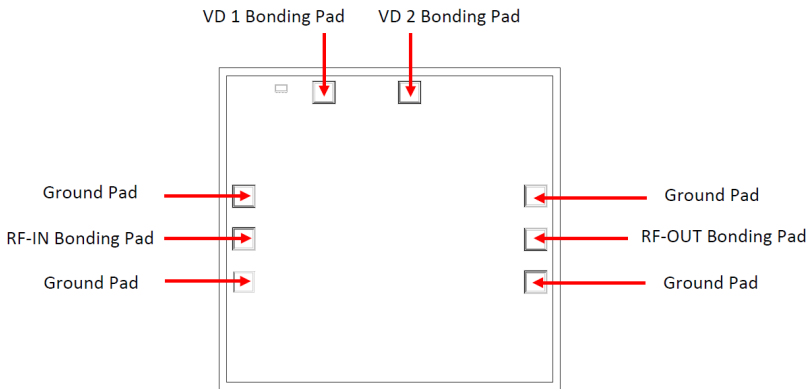

Fig 2. Die Layout

Bonding Pad Position
(Dimensions in μm , Typical)

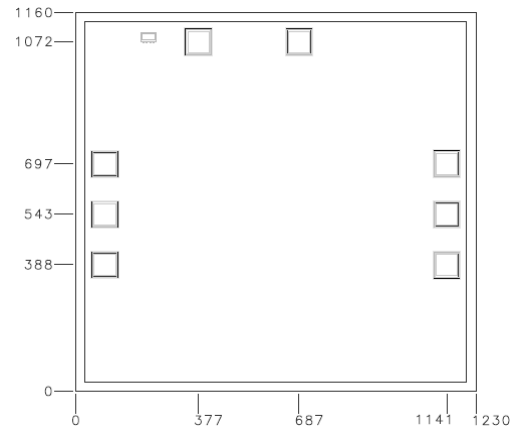

Fig 3. Bonding Pad Positions

Critical Dimensions

Parameter	Values
Die Thickness, μm	100
Die Width, μm	1230
Die Length, μm	1160
Bond Pad Size, μm	80 x 80

Assembly and Handling Procedure

1. Storage
Dice should be stored in a dry nitrogen purged desiccators or equivalent.
2. ESD
MMIC PHEMT amplifier dice are susceptible to electrostatic and mechanical damage. Die are supplied in antistatic protected material, which should be opened in clean room conditions at an appropriately grounded anti-static workstation. Devices need careful handling using correctly designed collets, vacuum pickup tips or sharp antistatic tweezers to deter ESD damage to dice.
3. Die Attach
The die mounting surface must be clean and flat. Using conductive silver filled epoxy, recommended epoxies are DieMat DM6030HK-PT/H579 or Ablestik 84-1LMISR4. Apply sufficient epoxy to meet required epoxy bond line thickness, epoxy fillet height and epoxy coverage around total die periphery. Parts shall be cured in a nitrogen filled atmosphere per manufacturer's cure condition. It is recommended to use antistatic die pick up tools only.
4. Wire Bonding
Bond pad openings in the surface passivation above the bond pads are provided to allow wire bonding to the dice gold bond pads. Thermosonic bonding is used with minimized ultrasonic content. Bond force, time, ultrasonic power and temperature are all critical parameters. Suggested wire is pure gold, 1 mil diameter. Bonds must be made from the bond pads on the die to the package or substrate. All bond wires should be kept as short as low as reasonable to minimize performance degradation due to undesirable series inductance.

Assembly Diagram

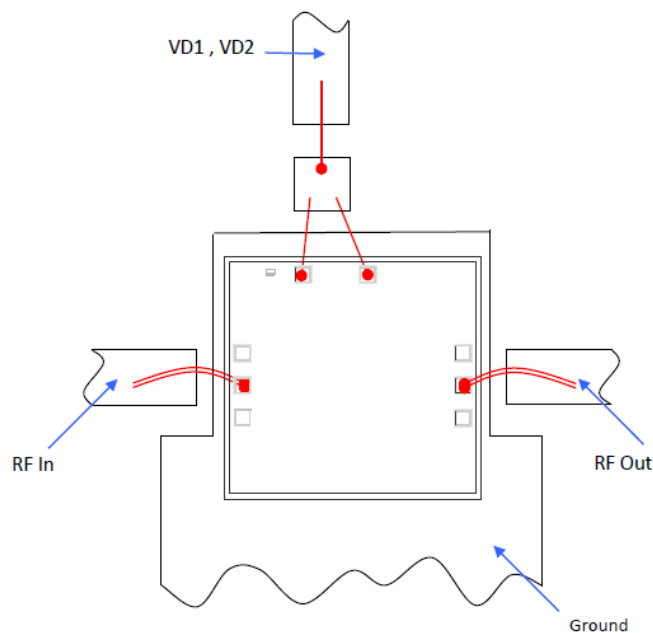

Recommended Wire Length, Typical

Wire	Wire Length (mm)	Wire Loop Height (mm)
RF-In, RF-Out	0.25	0.15
VD1, VD2	0.50	0.15

PCB Information

PCB material	Rogers 435013
Dielectric thickness	10 mil
Copper thickness (Top & Bottom)	0.5 oz.
Finish	ENIG

Additional Detailed Technical Information <i>additional information is available on our dash board.</i>	
Performance Data	Data Table
	Swept Graphs
	S-Parameter (S2P Files) Data Set with and without port extension(.zip file)
Case Style	Die
Die Ordering and packaging information	Quantity, Package Model No. Small, Gel - Pak: 10,50,100 KGD* AVA-24A-DG+ Medium†, Partial wafer: KGD*<1190 AVA-24A-DP+ Large†, Full Wafer AVA-24A-DF+
	†Available upon request contact sales representative Refer to AN-60-067
Environmental Ratings	ENV-80

*Known Good Dice ("KGD") means that the dice in question have been subjected to Mini-Circuits DC test performance criteria and measurement instructions and that the parametric data of such dice fall within a predefined range. While DC testing is not definitive, it does help to provide a higher degree of confidence that dice are capable of meeting typical RF electrical parameters specified by Mini-Circuits.

ESD Rating**

Human Body Model (HBM): Class 1A (250 to <500V) in accordance with ANSI/ESD STM 5.1 - 2001

** Tested in industry standard 3x3 mm 8-lead MCLP package.

Additional Notes

- Performance and quality attributes and conditions not expressly stated in this specification document are intended to be excluded and do not form a part of this specification document.
- Electrical specifications and performance data contained in this specification document are based on Mini-Circuit's applicable established test performance criteria and measurement instructions.
- The parts covered by this specification document are subject to Mini-Circuits standard limited warranty and terms and conditions (collectively, "Standard Terms"); Purchasers of this part are entitled to the rights and benefits contained therein. For a full statement of the Standard Terms and the exclusive rights and remedies thereunder, please visit Mini-Circuits' website at www.minicircuits.com/MCLStore/terms.jsp
- Mini-Circuits does not warrant the accuracy or completeness of the information, text, graphics and other items contained within this document and same are provided as an accommodation and on an "As is" basis, with all faults.
- Purchasers of this part are solely responsible for proper storing, handling, assembly and processing of Known Good Dice (including, without limitation, proper ESD preventative measures, die preparation, die attach, wire bonding and related assembly and test activities), and Mini-Circuits assumes no responsibility therefor or for environmental effects on Known Good Dice.
- Mini-Circuits and the Mini-Circuits logo are registered trademarks of Scientific Components Corporation d/b/a Mini-Circuits. All other third-party trademarks are the property of their respective owners. A reference to any third-party trademark does not constitute or imply any endorsement, affiliation, sponsorship, or recommendation by any such third-party of Mini-Circuits or its products.

