



CERAMIC

Bandpass Filter

BFHK-8501+

Mini-Circuits

50Ω 7.5 to 8.8 GHz

THE BIG DEAL

- Ultra-High Stopband Rejection Structure – 90 dB typical
- Surface mountable pick and place standard case style
- Standard small 1812 (4.5mm x 3.2mm) case style
- High quality distributed filter topology
- Wide rejection band
- Shielded construction preventing filter from de-tuning
- Reduced footprint area by employing LGA (land grid array)
- Suited for very high-volume production
- Protected by US Patents 11,638,370 and 11,744,057



Generic photo used for illustration purposes only

CASE STYLE: NM1812C-3

+RoHS Compliant

The +Suffix identifies RoHS Compliance. See our website for methodologies and qualifications

APPLICATIONS

- Test and Measurement
- Aerospace and Defense Signal Conditioning

PRODUCT OVERVIEW

The BFHK-8501+ LTCC Band Pass Filter achieves a miniature size and high repeatability of performance by utilizing a proprietary LTCC material system and distributed filter topology. The passband loss at 7.5 – 8.8 GHz is as low as 3.1 dB, with typical stopband rejections at 90 dB up to 25 GHz. This model handles up to 1W RF input power, and provides a wide operating temperature range from -55 to +125°C. Utilizing a proprietary LTCC material system and a distributed filter topology, this filter is able to achieve repeatable performance on a lot-to-lot basis, up to mmWave frequencies.

KEY FEATURES

Feature	Advantages
Ultra-High Rejection	Typical stopband rejections at 90 dB up to 25 GHz
Cost effective	LTCC is scalable technology that is cost effective due to ease of production in high quantities.
Small size (4.5mm x 3.2mm)	Allows for high layout density of circuit boards, while minimizing effects of parasitics.
Surface Mountable	Suitable for very high volume automated assembly process.

REV. A
ECO-019695
BFHK-8501+
WY/CP/PS
231102





CERAMIC

Bandpass Filter

BFHK-8501+

ELECTRICAL SPECIFICATIONS¹ AT 25°C

Parameter	F#	Frequency (GHz)	Min.	Typ.	Max.	Units	
Pass Band	Center Frequency	—	—	8.1	—	GHz	
	Insertion Loss	F1-F2	7.5 - 8.8	—	3.1	4.5	dB
	Return Loss	F1-F2	7.5 - 8.8	—	12	—	dB
Stop Band, Lower	Insertion Loss	DC-F3	2.0 - 4.7	80	90	—	dB
Stop Band, Upper	Insertion Loss	F4-F5	11.9 - 25	80	90	—	dB

1. Measured on Mini-Circuits Test Board TB-BFHK-8501C+ with feedline losses removed by normalization of S12 and S21 traces to measurement of TB thru-line.

MAXIMUM RATINGS

Parameter	Ratings
Operating Temperature	-55°C to 125°C
Storage Temperature	-55°C to 125°C
RF Power Input	1W max.

Permanent damage may occur if any of these limits are exceeded

TYPICAL FREQUENCY RESPONSE

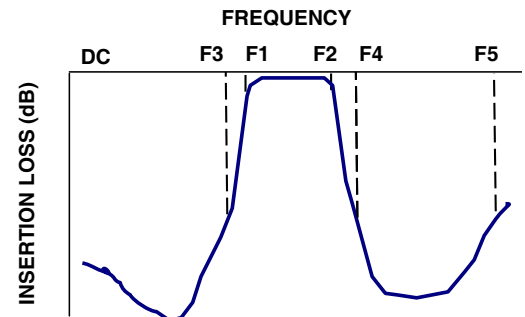

FUNCTIONAL SCHEMATIC

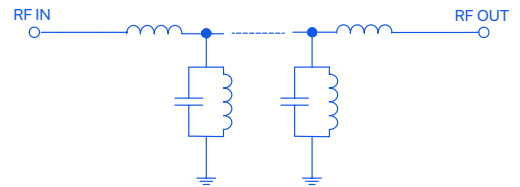



CERAMIC

Bandpass Filter

BFHK-8501+

EVALUATION BOARD MCL P/N: TB-BFHK-8501C+ SUGGESTED PCB LAYOUT: PL-730

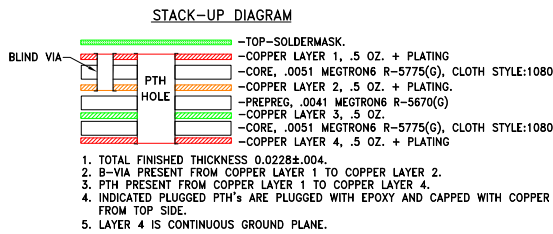
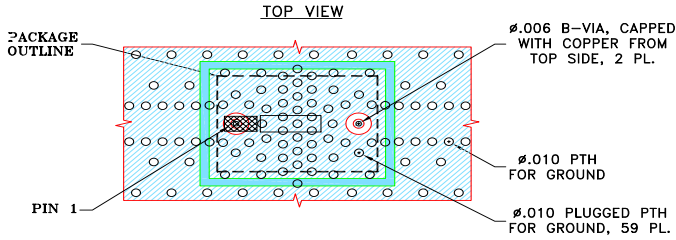

NOTES:

- PCB IS MULTILAYER PCB, SEE STACK-UP DIAGRAM.
- TRACE WIDTH & GAP PARAMETERS ARE SHOWN FOR MEGTRON6 R-5775(G), CLOTH STYLE:1080 WITH DIELECTRIC THICKNESS .0051; COPPER: 1/2 OZ.+PLATING. FOR OTHER MATERIALS TRACE WIDTH AND GAP MAY NEED TO BE MODIFIED.
- COPPER LAYER 4 OF THE PCB ARE CONTINUOUS GROUND PLANE.

- DENOTES PCB COPPER LAYOUT WITH SMOBC (SOLDER MASK OVER BARE COPPER)
- DENOTES COPPER LAND PATTERN FREE OF SOLDER MASK

LAYER 2, B-VIA & PTH

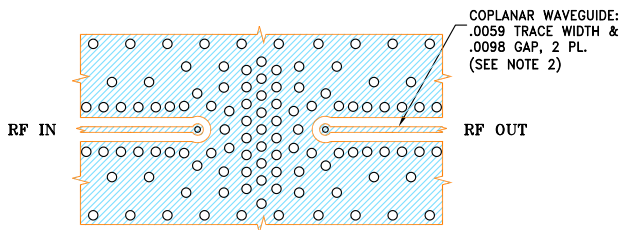

LAYER 3 & PTH

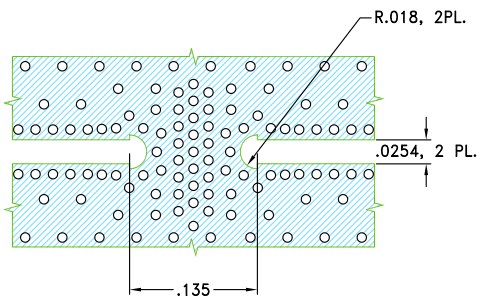

PAD CONNECTIONS

INPUT	1
OUTPUT	2
GROUND	3

PRODUCT MARKING: F440

OUTLINE DRAWING

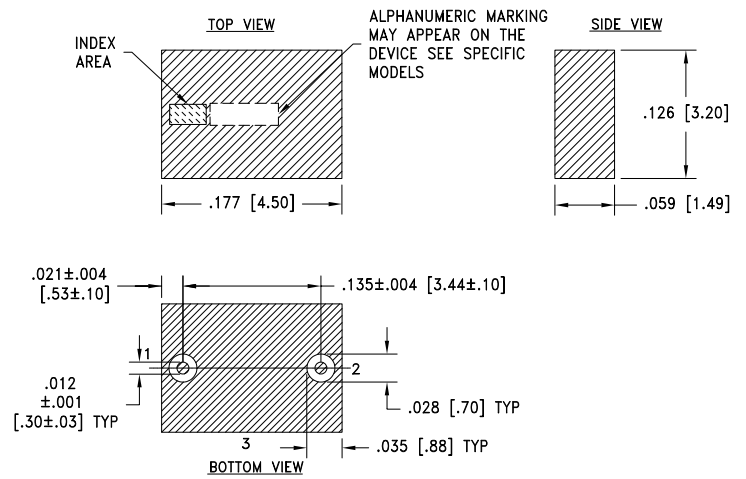

Weight: .126 grams.

Dimensions are in inches (mm). Tolerances: 2 Pl.±.01; 3 Pl. ±.005



CERAMIC

Bandpass Filter

BFHK-8501+

TYPICAL PERFORMANCE DATA

Frequency (MHz)	Insertion Loss (dB)	Return Loss (dB)
10	68.13	0.05
2000	110.07	0.43
3000	114.78	0.63
4700	95.94	0.70
6000	66.50	0.76
7500	2.59	15.68
8100	2.32	29.74
8800	2.78	25.90
10500	65.57	1.80
11900	104.42	1.66
13500	105.16	1.15
15000	101.10	1.78
16500	100.74	2.16
18000	117.69	1.83
19500	110.59	1.57
21000	113.71	2.31
23000	108.05	2.34
24000	99.79	2.31
25000	112.14	2.19
27000	93.35	2.65
30000	15.32	4.55

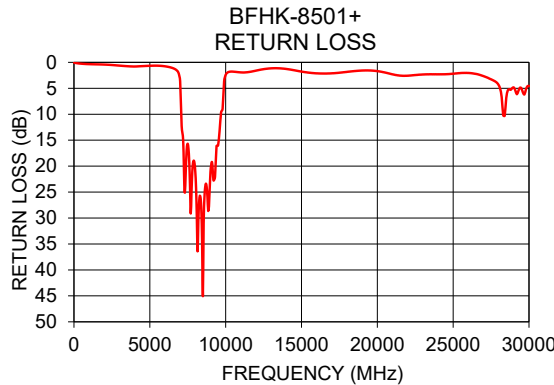
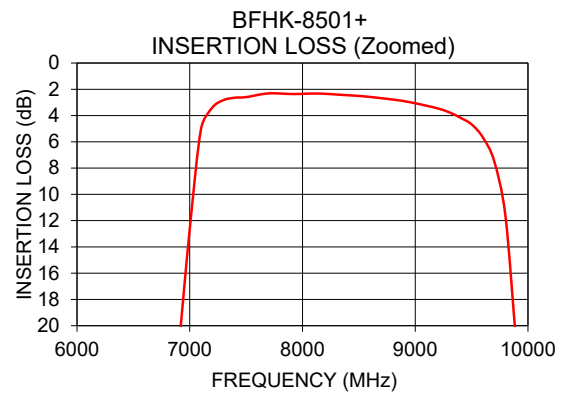
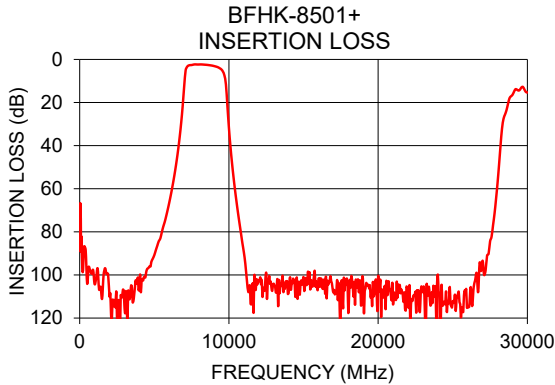

- NOTES**
- A. Performance and quality attributes and conditions not expressly stated in this specification document are intended to be excluded and do not form a part of this specification document.
 - B. Electrical specifications and performance data contained in this specification document are based on Mini-Circuit's applicable established test performance criteria and measurement instructions.
 - C. The parts covered by this specification document are subject to Mini-Circuits standard limited warranty and terms and conditions (collectively, "Standard Terms"); Purchasers of this part are entitled to the rights and benefits contained therein. For a full statement of the standard. Terms and the exclusive rights and remedies thereunder, please visit Mini-Circuits' website at www.minicircuits.com/MCLStore/terms.jsp

