

50Ω 5500 to 7000 MHz

## The Big Deal

- Termination insensitive
- Low Insertion Loss: 1.6 dB
- Large attenuation range: 27 dB



CASE STYLE: CZ682

## Product Overview

The Mini-Circuits HVA series, surface mount, constant impedance voltage variable attenuators provide excellent attenuation and linearity performance while maintaining constant RF impedance across the attenuation range. Built using Mini-Circuits proven shielded module construction technology, these models integrate dual pin diodes along with internal 90 degree hybrids. This termination insensitive approach allows more flexibility so designers can locate the attenuators anywhere in their lineup, including cascading VVAs for true attenuation addition without VSWR interaction degrading the usable attenuation range.

## Key Features

Feature	Advantages
Constant Impedance (Termination insensitive)	The HVA series VVA incorporates 90° hybrids to buffer internal circuits from source and load mismatch. This unique feature enables the HVA series to maintain performance independent of source and load impedance, and allows units to be cascaded with true additive attenuation.
Excellent flatness	Typical attenuation flatness less than 1 dB typ. across the full band from 0 to 25 dB attenuation is great for feed forward applications.
Return Loss	17 dB typ return loss across frequency and control voltage ranges provides an excellent match under all operating conditions allowing straightforward cascading.
High IP3	High +43 dBm IP3 typ. at min attenuation and +35 dBm typ. up to 1.0V allows flexibility to locate VVA in lineup where attenuation is required the most without degrading system linearity.

### Notes

- A. Performance and quality attributes and conditions not expressly stated in this specification document are intended to be excluded and do not form a part of this specification document.  
 B. Electrical specifications and performance data contained in this specification document are based on Mini-Circuit's applicable established test performance criteria and measurement instructions.  
 C. The parts covered by this specification document are subject to Mini-Circuits standard limited warranty and terms and conditions (collectively, "Standard Terms"); Purchasers of this part are entitled to the rights and benefits contained therein. For a full statement of the Standard Terms and the exclusive rights and remedies thereunder, please visit Mini-Circuits' website at [www.minicircuits.com/MCLStore/terms.jsp](http://www.minicircuits.com/MCLStore/terms.jsp)

# Voltage Variable Attenuator

## HVA-73+

50Ω 5500 to 7000 MHz



Generic photo used for illustration purposes only

CASE STYLE: CZ682

### Maximum Ratings

Operating Temperature	-40°C to 85°C
Storage Temperature	-55°C to 100°C
Absolute Max. Control Current	10 mA
Absolute Max. RF Input Level	+15 dBm
Permanent damage may occur if any of these limits are exceeded.	

### Pin Connections

RF IN	1
V CONTROL 1	3
V CONTROL 2	5
RF OUT	7
GROUND	2,4,6,8

### Features

- low insertion loss, 1.6 dB typ.
- high attenuation, 27 dB typ.
- good return loss, 17 dB typ.

### Applications

- variable gain amplifier
- feed forward amps
- ALC circuits

**+RoHS Compliant**

The +Suffix identifies RoHS Compliance. See our web site for RoHS Compliance methodologies and qualifications

### Electrical Specifications

Parameter	Condition	Min.	Typ.	Max.	Units
Frequency Range		5500	—	7000	MHz
Insertion Loss	at 0V Control Voltage	—	1.6	2.3	dB
Attenuation		22	27	—	dB
IP3 <sup>1</sup>	at 0V Control Voltage	40	48	—	dBm
Input Return Loss		—	17	—	dB
Output Return Loss		—	17	—	dB
Control Voltage		0-6			V

1. Input IP3 tested with two tones separated by 0.1 MHz at 0 dBm each and 0V control voltage.

### Outline Drawing

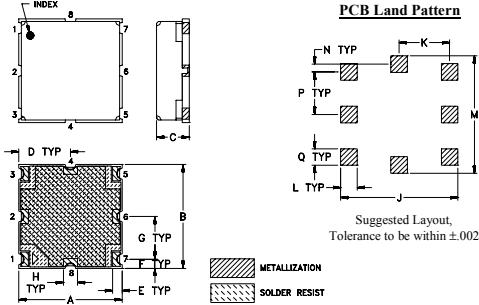

### Outline Dimensions (inch/mm)

A	B	C	D	E	F	G	H
.375	.375	.131	.188	.035	.033	.154	.050
9.52	9.52	3.33	4.77	0.89	0.84	3.91	1.27
J	K	L	M	N	P	Q	wt
.425	.183	.060	.425	.028	.154	.060	grams
10.80	4.65	1.52	10.80	0.71	3.91	1.52	0.60

### Demo Board MCL P/N: TB-511+ Suggested PCB Layout (PL-323)

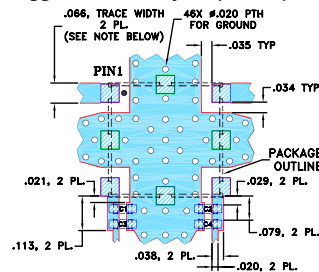

CAPACITORS C1, C2: 1000 pF, 0603 SIZE;  
C3, C4: 68 pF, 0603 SIZE.

NOTES: 1. TRACE WIDTH IS SHOWN FOR ROGERS RO4350B WITH DIELECTRIC THICKNESS 0.030" ± 0.002"; COPPER: 1/2 OZ. EACH SIDE. FOR OTHER MATERIALS TRACE WIDTH MAY NEED TO BE MODIFIED.  
2. BOTTOM SIDE OF THE PCB IS CONTINUOUS GROUND PLANE.

- DENOTES PCB COPPER LAYOUT WITH SMOBC (SOLDER MASK OVER BARE COPPER)
- DENOTES COPPER LAND PATTERN FREE OF SOLDER MASK

### Notes

A. Performance and quality attributes and conditions not expressly stated in this specification document are intended to be excluded and do not form a part of this specification document.  
B. Electrical specifications and performance data contained in this specification document are based on Mini-Circuit's applicable established test performance criteria and measurement instructions.  
C. The parts covered by this specification document are subject to Mini-Circuit's standard limited warranty and terms and conditions (collectively, "Standard Terms"); Purchasers of this part are entitled to the rights and benefits contained therein. For a full statement of the Standard Terms and the exclusive rights and remedies thereunder, please visit Mini-Circuit's website at [www.minicircuits.com/MCLStore/terms.jsp](http://www.minicircuits.com/MCLStore/terms.jsp)

### Equivalent Schematic of DUT

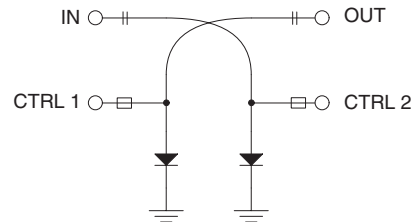

HVA-73+  
TYPICAL ATTENUATION at 6260 MHz

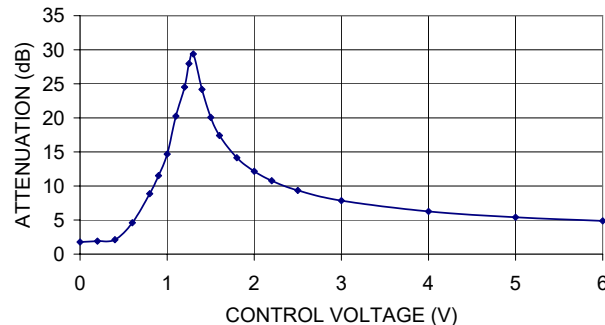

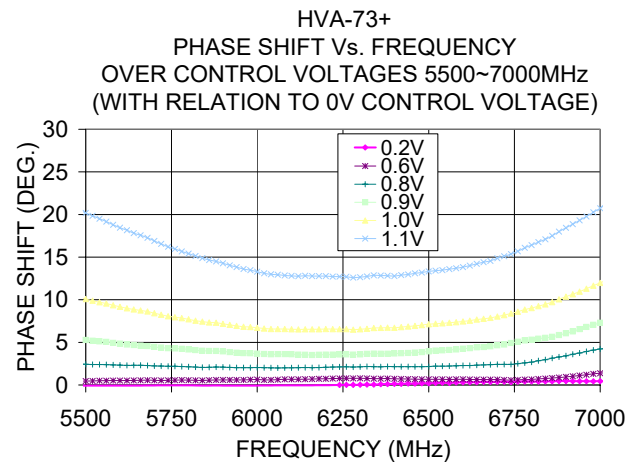
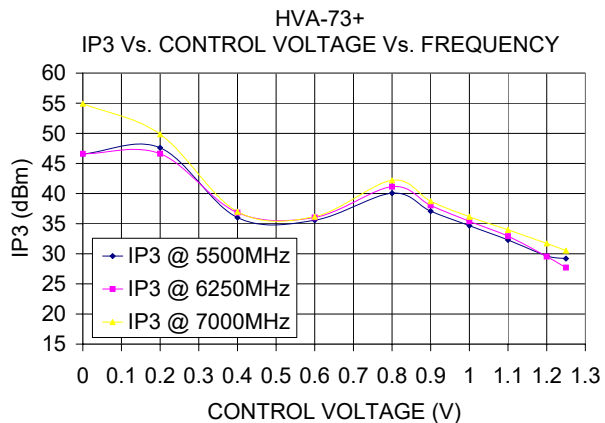
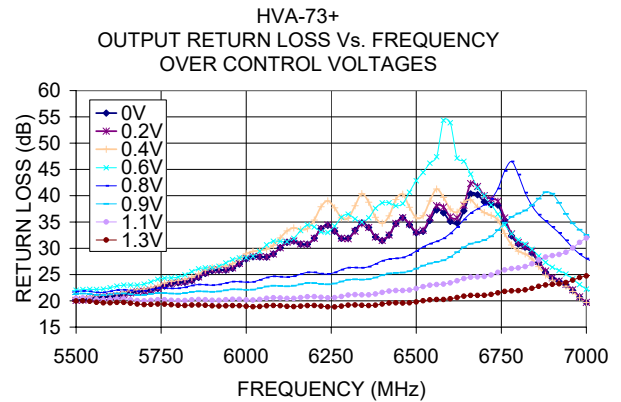
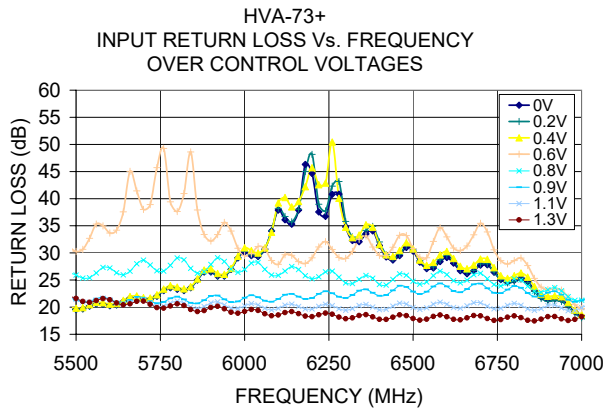
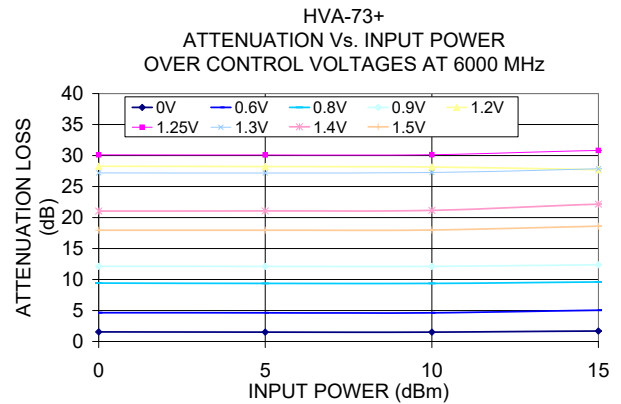
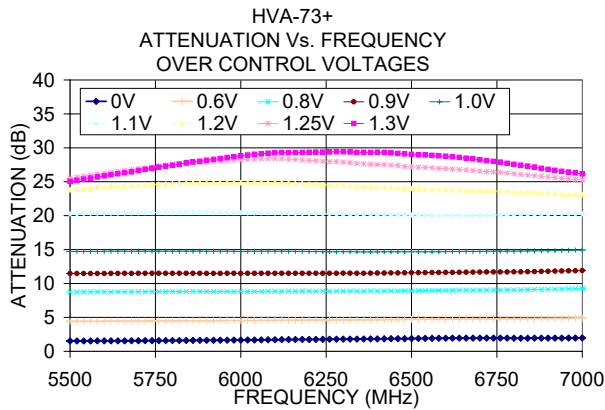

**Notes**

- A. Performance and quality attributes and conditions not expressly stated in this specification document are intended to be excluded and do not form a part of this specification document.
- B. Electrical specifications and performance data contained in this specification document are based on Mini-Circuit's applicable established test performance criteria and measurement instructions.
- C. The parts covered by this specification document are subject to Mini-Circuits standard limited warranty and terms and conditions (collectively, "Standard Terms"); Purchasers of this part are entitled to the rights and benefits contained therein. For a full statement of the Standard Terms and the exclusive rights and remedies thereunder, please visit Mini-Circuits' website at [www.minicircuits.com/MCLStore/terms.jsp](http://www.minicircuits.com/MCLStore/terms.jsp)

