

NON-CATALOG

Frequency Synthesizer

KSN-2280A-119+

50Ω 2151.76 to 2271.76 MHz

The Big Deal

- Fractional N synthesizer
- Low phase noise and spurious
- Robust design and construction
- Small size 0.80" x 0.58" x 0.15"



CASE STYLE: DK1042

Product Overview

The KSN-2280A-119+ is a Frequency Synthesizer, designed to operate from 2151.76 to 2271.76 MHz for TD-SCDMA application. The KSN-2280A-119+ is packaged in a metal case (size of 0.80" x 0.58" x 0.15") to shield against unwanted signals and noise.

Key Features

Feature	Advantages
Low phase noise and spurious: <ul style="list-style-type: none">• Phase Noise: -97 dBc/Hz typ. @ 10 kHz offset• Step Size Spurious: -78 dBc typ.• Comparison Spurious: -100 dBc typ.• Reference Spurious: -100 dBc typ.	Low phase noise and spurious improve system EVM (Error Vector Magnitude).
Robust design and construction	To enhance the robustness of KSN-2280A-119+, each internal component is secured to the substrate with chip bonder, thereby eliminating the risk of tombstoning during subsequent solder reflow operations by the customer.
Small size, 0.80" x 0.58" x 0.15"	The small size enables the KSN-2280A-119+ to be used in compact designs.



For detailed performance specs & shopping online see web site

P.O. Box 350166, Brooklyn, New York 11235-0003 (718) 934-4500 Fax (718) 332-4661 The Design Engineers Search Engine  Provides ACTUAL Data Instantly at minicircuits.com

IF/RF MICROWAVE COMPONENTS

Notes: 1. Performance and quality attributes and conditions not expressly stated in this specification sheet are intended to be excluded and do not form a part of this specification sheet. 2. Electrical specifications and performance data contained herein are based on Mini-Circuit's applicable established test performance criteria and measurement instructions. 3. The parts covered by this specification sheet are subject to Mini-Circuits standard limited warranty and terms and conditions (collectively, "Standard Terms"); Purchasers of this part are entitled to the rights and benefits contained therein. For a full statement of the Standard Terms and the exclusive rights and remedies thereunder, please visit Mini-Circuits' website at www.minicircuits.com/MCLStore/terms.jsp.

50Ω 2151.76 to 2271.76 MHz

Features

- Fractional N synthesizer
- Integrated VCO + PLL
- Low phase noise and spurious
- Robust design and construction
- Low operating voltage (VCC VCO=+5V, VCC PLL=+5V)
- Small size 0.80" x 0.58" x 0.15"

Applications

- TD-SCDMA

General Description

The KSN-2280A-119+ is a Frequency Synthesizer, designed to operate from 2151.76 to 2271.76 MHz for TD-SCDMA application. The KSN-2280A-119+ is packaged in a metal case (size of 0.80" x 0.58" x 0.15) to shield against unwanted signals and noise. To enhance the robustness of KSN-2280A-119+, each internal component is secured to the substrate with chip bonder, thereby eliminating the risk of tombstoning during subsequent solder reflow operations by the customer.



CASE STYLE: DK1042

+ RoHS compliant in accordance with EU Directive (2002/95/EC)

The +Suffix has been added in order to identify RoHS Compliance. See our web site for RoHS Compliance methodologies and qualifications.

Simplified Schematic

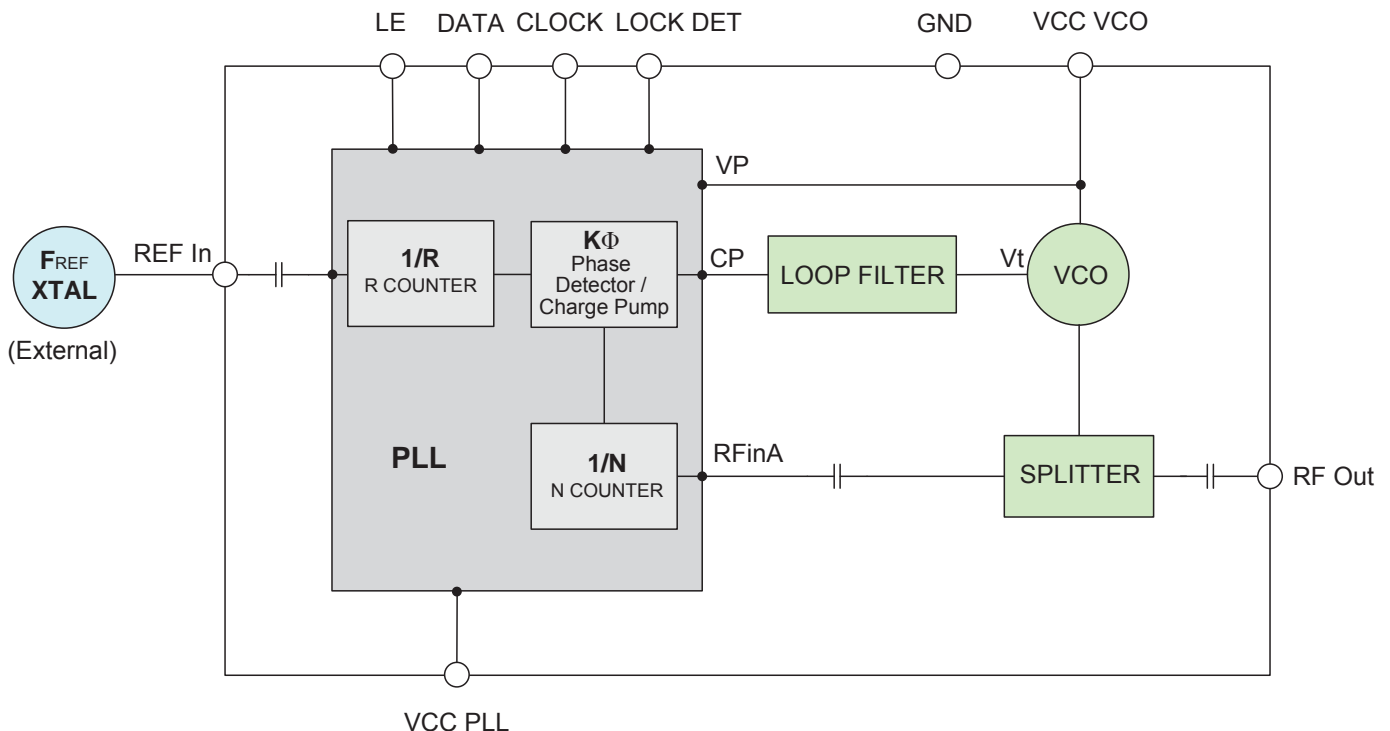

Electrical Specifications (over operating temperature -40°C to +85°C)

Parameters	Test Conditions	Min.	Typ.	Max.	Units
Frequency Range	-	2151.76	-	2271.76	MHz
Step Size	-	-	20	-	kHz
Comparison Frequency	-	-	15.36	-	MHz
Settling Time	Within ± 1 kHz	-	25	-	mSec
Output Power	-	+2	+5	+7	dBm
SSB Phase Noise	@ 100 Hz offset	-	-75	-	dBc/Hz
	@ 1 kHz offset	-	-82	-75	
	@ 10 kHz offset	-	-97	-89	
	@ 100 kHz offset	-	-127	-122	
	@ 1 MHz offset	-	-148	-142	
Integrated SSB Phase Noise	@ 1 kHz to 5MHz	-	-46	-41	dBc
Step Size Spurious Suppression	Step Size 20 kHz	-	-78	-60	dBc
0.5 Step Size Spurious Suppression	0.5 Step Size 10 kHz	-	-68	-57	
Reference Spurious Suppression	Ref. Freq. 30.72 MHz	-	-100	-75	
Comparison Spurious Suppression	Comp. Freq. 15.36 MHz	-	-100	-77	
Non - Harmonic Spurious Suppression	-	-	-90	-	
Harmonic Suppression	-	-	-36	-22	
VCO Supply Voltage	+5.00	+4.75	+5.00	+5.25	V
PLL Supply Voltage	+5.00	+4.75	+5.00	+5.25	
VCO Supply Current	-	-	45	51	mA
PLL Supply Current	-	-	39	46	
Reference Input (External)	Frequency	30.72 (square wave)	-	30.72	MHz
	Amplitude	1	-	1	V _{P-P}
	Input impedance	-	-	100	KΩ
	Phase Noise @ 1 kHz offset	-	-	-130	dBc/Hz
RF Output port Impedance	-	-	50	-	Ω
Input Logic Level	Input high voltage	-	2.7	-	V
	Input low voltage	-	-	0.6	V
Digital Lock Detect	Locked	-	2.6	3.4	V
	Unlocked	-	-	0.4	V
Frequency Synthesizer PLL	-	ADF4153			
PLL Programming	-	3-wire serial 3V CMOS			
Register Map @ 2271.76MHz	R0_Register	-	(MSB) 001001001100101011010000 (LSB)		
	R1_Register	-	(MSB) 000101001000110000000001 (LSB)		
	R2_Register	-	(MSB) 0000000111100010 (LSB)		
	R3_Register	-	(MSB) 000000000011 (LSB)		

Absolute Maximum Ratings

Parameters	Ratings
VCO Supply Voltage	5.8V
PLL Supply Voltage	5.8V
VCO Supply Voltage to PLL Supply Voltage	-0.3V to +5.8V
Reference Frequency Voltage	-0.3Vmin, +3.3Vmax
Data, Clock, LE Levels	-0.3Vmin, +3.3Vmax
Operating Temperature	-40°C to +85°C
Storage Temperature	-55°C to +100°C

Permanent damage may occur if any of these limits are exceeded

NON-CATALOG

Frequency Synthesizer

KSN-2280A-119+

Typical Performance Data

FREQUENCY (MHz)	POWER OUTPUT (dBm)			VCO CURRENT (mA)			PLL CURENT (mA)		
	-45°C	+25°C	+85°C	-45°C	+25°C	+85°C	-45°C	+25°C	+85°C
	2151.76	4.99	5.11	4.97	42.55	44.53	45.62	37.35	38.65
2169.00	5.08	5.17	5.02	42.59	44.58	45.66	37.44	38.76	40.23
2192.00	5.18	5.26	5.11	42.67	44.65	45.72	37.43	38.75	40.22
2215.00	5.18	5.25	5.12	42.77	44.73	45.79	37.45	38.77	40.25
2238.00	5.01	5.08	4.92	42.84	44.80	45.86	37.48	38.82	40.30
2261.00	5.02	5.06	4.84	42.90	44.86	45.92	37.46	38.79	40.27
2271.76	5.08	5.11	4.89	42.93	44.89	45.95	37.40	38.75	40.22

FREQUENCY (MHz)	HARMONICS (dBc)					
	F2			F3		
	-45°C	+25°C	+85°C	-45°C	+25°C	+85°C
2151.76	-35.05	-42.43	-38.35	-33.21	-35.43	-38.00
2169.00	-32.06	-40.48	-38.69	-33.97	-36.87	-39.59
2192.00	-31.73	-38.34	-40.39	-33.92	-36.09	-38.34
2215.00	-31.82	-40.76	-38.28	-33.03	-37.32	-40.88
2238.00	-28.76	-34.28	-41.34	-33.20	-36.51	-38.99
2261.00	-32.48	-37.85	-37.96	-37.07	-39.98	-42.13
2271.76	-32.27	-38.08	-36.81	-39.59	-43.57	-45.22

FREQUENCY (MHz)	PHASE NOISE (dBc/Hz) @OFFSETS				
	+25°C				
	100Hz	1kHz	10kHz	100kHz	1MHz
2151.76	-77.31	-83.26	-96.72	-126.59	-146.74
2169.00	-77.39	-83.14	-98.44	-126.69	-147.26
2192.00	-76.14	-83.15	-98.02	-127.00	-147.69
2215.00	-76.22	-84.18	-97.27	-127.25	-147.59
2238.00	-73.89	-82.66	-97.29	-127.52	-147.86
2261.00	-76.24	-82.94	-97.01	-127.55	-148.00
2271.76	-74.47	-82.08	-96.65	-127.54	-148.05

FREQUENCY (MHz)	PHASE NOISE (dBc/Hz) @OFFSETS				
	-45°C				
	100Hz	1kHz	10kHz	100kHz	1MHz
2151.76	-74.14	-84.72	-95.37	-127.11	-147.55
2169.00	-77.14	-83.22	-95.99	-127.50	-147.89
2192.00	-76.43	-82.71	-95.50	-127.83	-148.29
2215.00	-75.10	-85.97	-94.68	-128.11	-148.60
2238.00	-76.71	-84.42	-94.72	-128.33	-149.14
2261.00	-75.62	-83.02	-94.19	-128.16	-149.28
2271.76	-76.53	-84.48	-93.43	-128.04	-149.06

FREQUENCY (MHz)	PHASE NOISE (dBc/Hz) @OFFSETS				
	+85°C				
	100Hz	1kHz	10kHz	100kHz	1MHz
2151.76	-80.21	-83.54	-95.90	-125.37	-145.77
2169.00	-79.37	-83.58	-97.85	-125.69	-146.17
2192.00	-78.66	-83.84	-97.65	-126.02	-146.28
2215.00	-80.24	-85.06	-96.56	-126.27	-146.68
2238.00	-78.26	-82.99	-96.36	-126.40	-146.99
2261.00	-81.55	-83.32	-96.00	-126.47	-146.96
2271.76	-77.84	-83.50	-95.50	-126.48	-147.04



For detailed performance specs & shopping online see web site

P.O. Box 350166, Brooklyn, New York 11235-0003 (718) 934-4500 Fax (718) 332-4661 The Design Engineers Search Engine Provides ACTUAL Data Instantly at minicircuits.com

IF/RF MICROWAVE COMPONENTS

Notes: 1. Performance and quality attributes and conditions not expressly stated in this specification sheet are intended to be excluded and do not form a part of this specification sheet. 2. Electrical specifications and performance data contained herein are based on Mini-Circuit's applicable established test performance criteria and measurement instructions. 3. The parts covered by this specification sheet are subject to Mini-Circuits standard limited warranty and terms and conditions (collectively, "Standard Terms"); Purchasers of this part are entitled to the rights and benefits contained therein. For a full statement of the Standard Terms and the exclusive rights and remedies thereunder, please visit Mini-Circuits' website at www.minicircuits.com/MCLStore/terms.jsp.

COMPARISON SPURIOUS ORDER	COMPARISON SPURIOUS @Fcarrier 2151.76MHz+(n*Fcomparison) (dBc) note 1			COMPARISON SPURIOUS @Fcarrier 2211.76MHz+(n*Fcomparison) (dBc) note 1			COMPARISON SPURIOUS @Fcarrier 2271.76MHz+(n*Fcomparison) (dBc) note 1			
	n	-45°C	+25°C	+85°C	-45°C	+25°C	+85°C	-45°C	+25°C	+85°C
	-5	-100.66	-99.94	-109.31	-116.98	-112.22	-107.86	-106.68	-101.27	-111.65
-4	-102.88	-99.01	-100.48	-103.21	-103.07	-100.54	-99.38	-102.41	-100.67	
-3	-112.02	-109.80	-105.30	-109.08	-113.42	-104.96	-103.42	-108.05	-105.77	
-2	-103.57	-104.06	-101.37	-100.22	-102.80	-100.98	-99.16	-104.79	-99.04	
-1	-102.32	-99.24	-98.58	-98.79	-99.90	-101.25	-98.57	-99.28	-97.88	
0 note 2	-	-	-	-	-	-	-	-	-	
+1	-97.32	-95.15	-102.19	-101.55	-101.18	-101.43	-101.62	-103.65	-98.09	
+2	-93.27	-92.60	-94.48	-95.38	-95.12	-95.01	-95.55	-97.82	-93.66	
+3	-102.14	-105.67	-102.38	-104.73	-99.44	-105.79	-106.97	-106.32	-104.36	
+4	-105.66	-107.73	-103.84	-103.59	-102.00	-102.93	-108.80	-110.30	-101.24	
+5	-116.25	-108.10	-112.91	-115.19	-109.00	-113.28	-117.72	-106.22	-108.16	

Note 1: Comparison frequency 15.36 MHz

Note 2: All spurs are referenced to carrier signal (n=0).

REFERENCE SPURIOUS ORDER	REFERENCE SPURIOUS @Fcarrier 2151.76MHz+(n*Freference) (dBc) note 3			REFERENCE SPURIOUS @Fcarrier 2211.76MHz+(n*Freference) (dBc) note 3			REFERENCE SPURIOUS @Fcarrier 2271.76MHz+(n*Freference) (dBc) note 3			
	n	-45°C	+25°C	+85°C	-45°C	+25°C	+85°C	-45°C	+25°C	+85°C
	-5	-93.32	-96.98	-95.61	-94.96	-97.55	-103.09	-94.17	-94.71	-100.26
-4	-94.69	-95.61	-100.04	-95.54	-98.08	-97.05	-93.87	-96.36	-94.93	
-3	-107.10	-101.35	-110.49	-107.00	-113.97	-129.19	-102.95	-99.32	-108.43	
-2	-103.02	-100.64	-99.79	-103.35	-102.92	-100.08	-99.46	-102.47	-100.81	
-1	-103.65	-106.85	-103.40	-100.14	-103.41	-99.57	-98.86	-104.49	-97.84	
0 note 4	-	-	-	-	-	-	-	-	-	
+1	-93.23	-93.71	-93.49	-95.31	-95.14	-94.06	-95.57	-97.73	-93.49	
+2	-106.23	-110.28	-104.29	-103.79	-102.08	-102.45	-108.62	-109.86	-101.58	
+3	-116.18	-114.92	-107.61	-113.14	-110.63	-116.31	-115.32	-106.51	-108.96	
+4	-98.33	-97.51	-107.70	-101.23	-106.38	-105.00	-100.52	-103.17	-101.12	
+5	-94.01	-101.07	-101.51	-100.30	-101.66	-112.54	-102.64	-105.39	-103.54	

Note 3: Reference frequency 30.72 MHz

Note 4: All spurs are referenced to carrier signal (n=0).

NON-CATALOG

Frequency Synthesizer

KSN-2280A-119+

STEP SIZE SPURIOUS ORDER	0.5 STEP SIZE & STEP SIZE SPURIOUS @Fcarrier 2151.76MHz+(n*Fstep size) (dBc) note 5			0.5 STEP SIZE & STEP SIZE SPURIOUS @Fcarrier 2211.76MHz+(n*Fstep size) (dBc) note 5			0.5 STEP SIZE & STEP SIZE SPURIOUS @Fcarrier 2271.76MHz+(n*Fstep size) (dBc) note 5		
	n	-45°C	+25°C	+85°C	-45°C	+25°C	+85°C	-45°C	+25°C
-5.0	-85.23	-86.64	-86.43	-88.52	-84.17	-83.66	-84.46	-87.90	-83.31
-4.5	-84.08	-85.53	-85.35	-85.42	-85.17	-84.98	-85.30	-83.89	-83.08
-4.0	-86.90	-85.31	-83.36	-69.94	-68.48	-67.62	-81.46	-84.51	-86.31
-3.5	-84.82	-84.34	-84.87	-82.08	-84.62	-82.76	-82.33	-82.61	-81.34
-3.0	-84.87	-86.36	-86.49	-83.75	-87.15	-83.80	-84.30	-88.81	-87.12
-2.5	-84.63	-85.66	-83.15	-84.50	-85.18	-86.72	-82.43	-85.82	-86.47
-2.0	-85.01	-85.26	-82.28	-85.70	-84.06	-87.02	-87.20	-80.64	-83.25
-1.5	-82.11	-82.08	-81.58	-77.89	-82.19	-80.66	-80.07	-83.86	-84.84
-1.0	-78.78	-79.85	-79.88	-77.35	-82.27	-79.40	-69.73	-72.51	-70.99
-0.5	-68.53	-68.23	-70.89	-68.41	-70.07	-69.53	-66.25	-65.61	-65.10
0 ^{note 6}	-	-	-	-	-	-	-	-	-
+0.5	-68.89	-70.73	-69.19	-67.52	-70.40	-68.89	-65.61	-66.18	-64.34
+1.0	-76.85	-81.89	-78.70	-78.46	-82.76	-81.27	-68.68	-71.10	-70.81
+1.5	-81.71	-84.61	-81.50	-76.71	-82.67	-82.37	-78.84	-81.06	-81.21
+2.0	-83.11	-87.05	-83.31	-87.82	-87.91	-81.63	-87.41	-85.11	-84.01
+2.5	-83.22	-87.52	-84.46	-84.76	-87.10	-86.89	-84.34	-86.21	-81.14
+3.0	-82.10	-82.96	-84.95	-85.38	-84.61	-84.26	-82.58	-87.83	-81.87
+3.5	-81.54	-86.04	-86.89	-81.93	-85.75	-86.57	-85.20	-85.22	-85.06
+4.0	-86.16	-84.03	-86.89	-69.93	-68.81	-67.62	-84.35	-87.22	-85.78
+4.5	-86.94	-82.92	-81.44	-85.55	-87.13	-86.43	-85.14	-84.57	-83.65
+5.0	-87.54	-83.80	-82.14	-85.61	-86.52	-82.01	-88.84	-86.32	-84.77

Note 5: Step size 20 kHz

Note 6: All spurs are referenced to carrier signal (n=0).



For detailed performance specs
& shopping online see web site

P.O. Box 350166, Brooklyn, New York 11235-0003 (718) 934-4500 Fax (718) 332-4661 The Design Engineers Search Engine Provides ACTUAL Data Instantly at minicircuits.com

IF/RF MICROWAVE COMPONENTS

Notes: 1. Performance and quality attributes and conditions not expressly stated in this specification sheet are intended to be excluded and do not form a part of this specification sheet. 2. Electrical specifications and performance data contained herein are based on Mini-Circuit's applicable established test performance criteria and measurement instructions. 3. The parts covered by this specification sheet are subject to Mini-Circuits standard limited warranty and terms and conditions (collectively, "Standard Terms"); Purchasers of this part are entitled to the rights and benefits contained therein. For a full statement of the Standard Terms and the exclusive rights and remedies thereunder, please visit Mini-Circuits' website at www.minicircuits.com/MCLStore/terms.jsp.

Typical Performance Curves

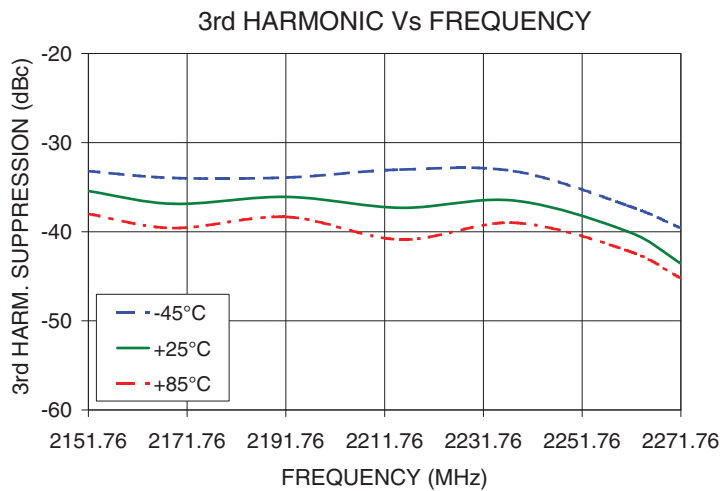
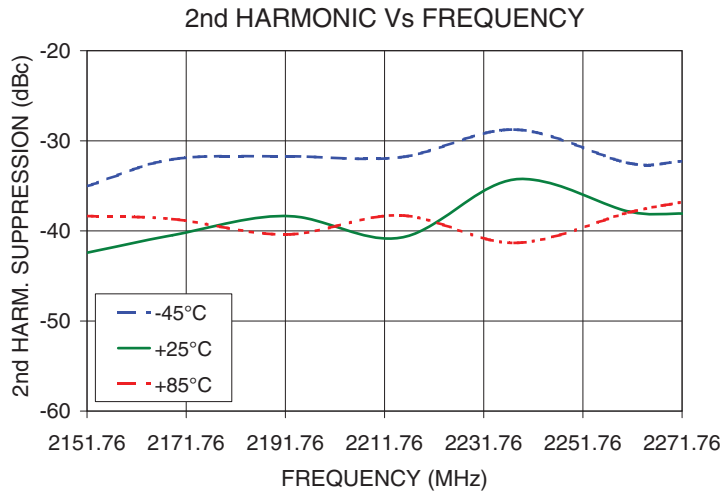
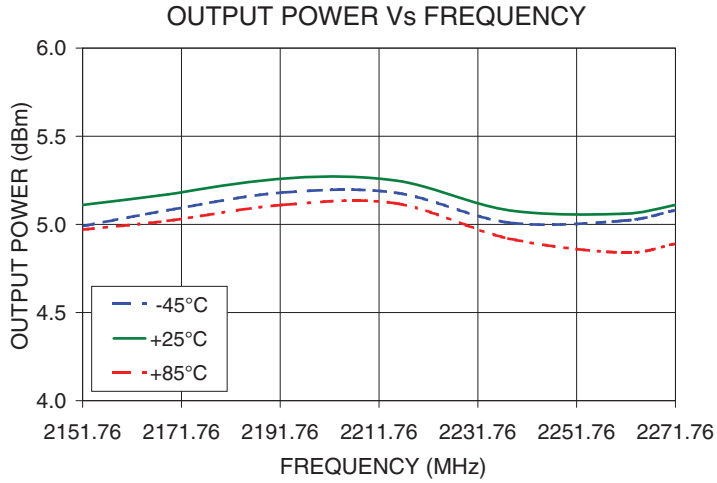

NON-CATALOG

Frequency Synthesizer

KSN-2280A-119+

PHASE NOISE @100Hz offset

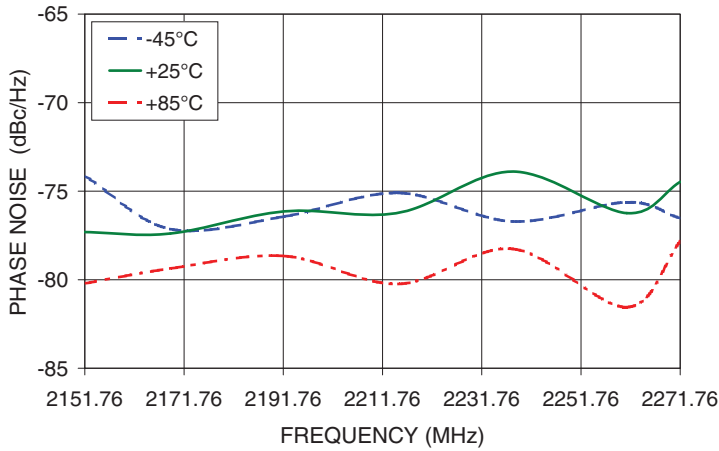

PHASE NOISE @1kHz offset

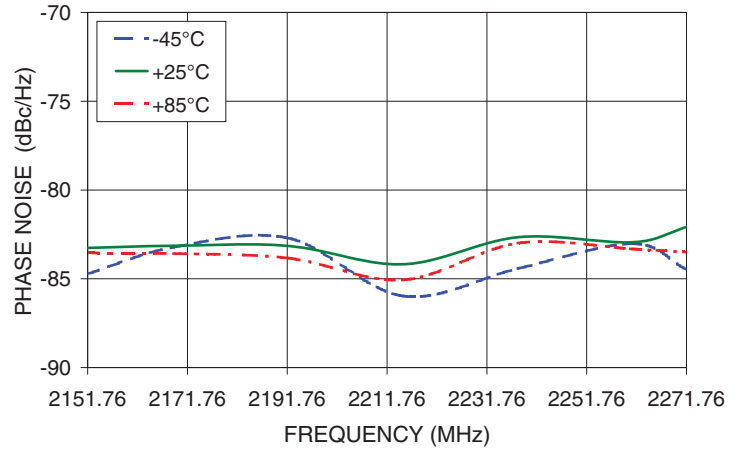

PHASE NOISE @10kHz offset

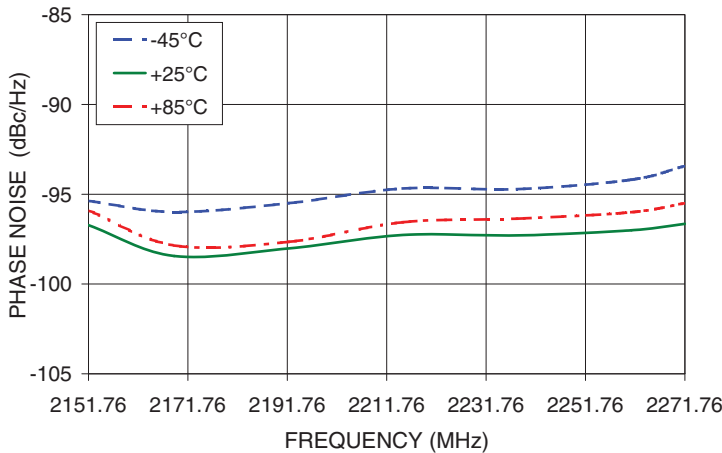

PHASE NOISE @100kHz offset

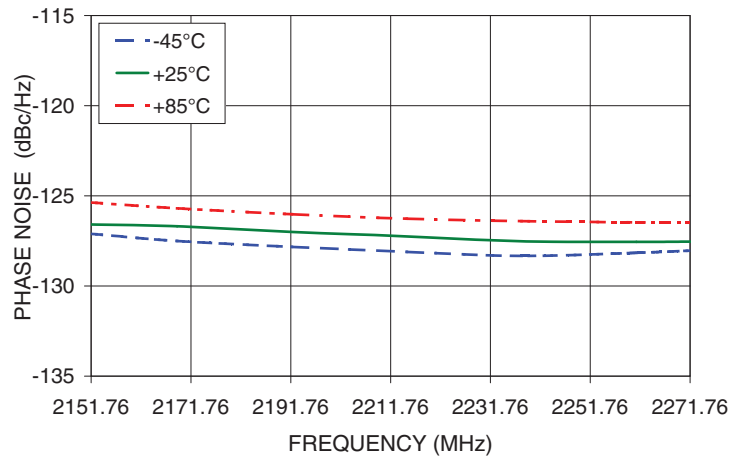

PHASE NOISE @1MHz offset

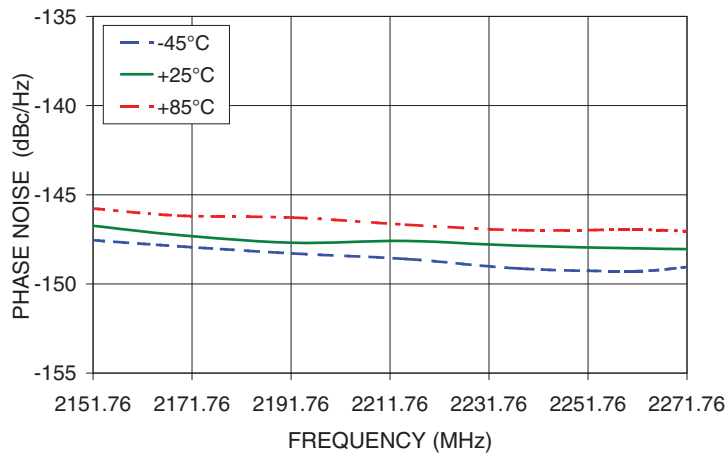

For detailed performance specs & shopping online see web site

P.O. Box 350166, Brooklyn, New York 11235-0003 (718) 934-4500 Fax (718) 332-4661 The Design Engineers Search Engine Provides ACTUAL Data Instantly at minicircuits.com

Notes: 1. Performance and quality attributes and conditions not expressly stated in this specification sheet are intended to be excluded and do not form a part of this specification sheet. 2. Electrical specifications and performance data contained herein are based on Mini-Circuit's applicable established test performance criteria and measurement instructions. 3. The parts covered by this specification sheet are subject to Mini-Circuits standard limited warranty and terms and conditions (collectively, "Standard Terms"); Purchasers of this part are entitled to the rights and benefits contained therein. For a full statement of the Standard Terms and the exclusive rights and remedies thereunder, please visit Mini-Circuits' website at www.minicircuits.com/MCLStore/terms.jsp.

NON-CATALOG

Frequency Synthesizer

KSN-2280A-119+

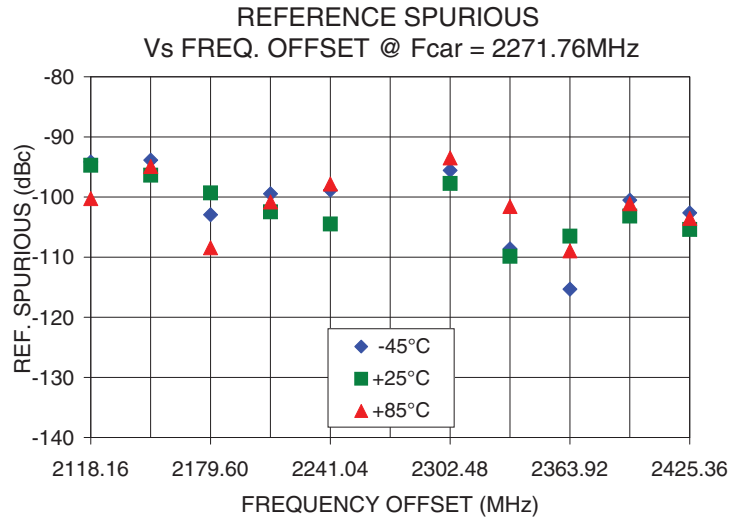
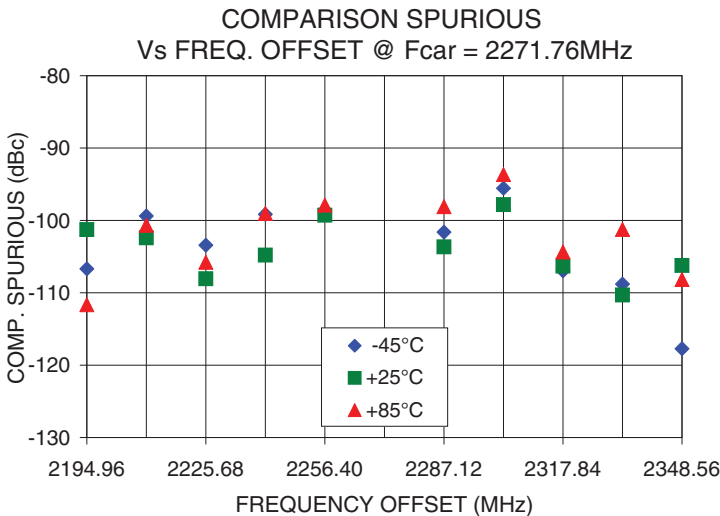
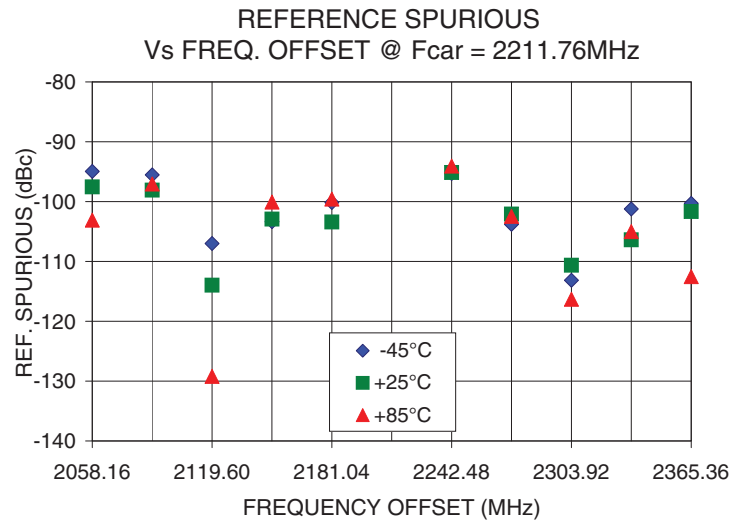
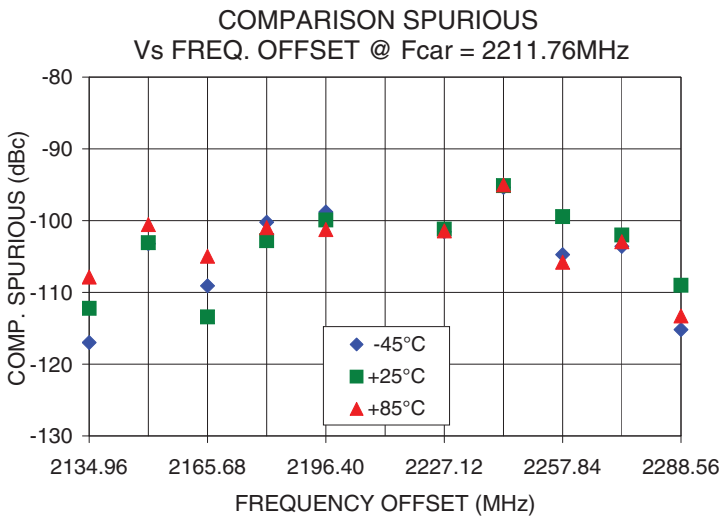
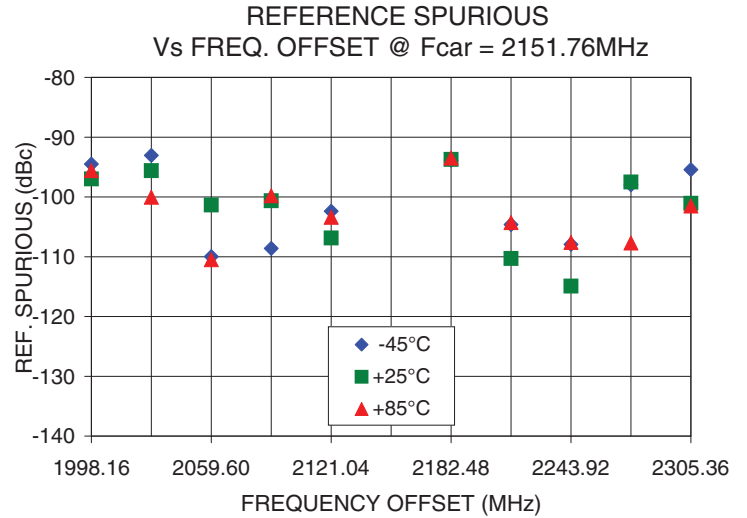
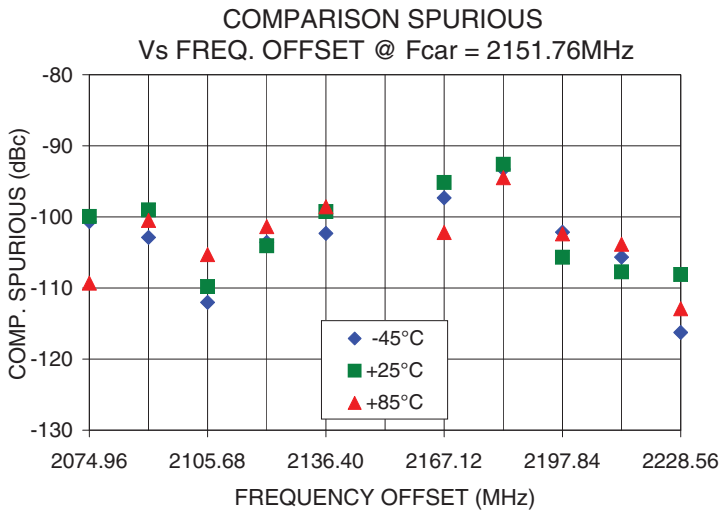

For detailed performance specs & shopping online see web site

P.O. Box 350166, Brooklyn, New York 11235-0003 (718) 934-4500 Fax (718) 332-4661 The Design Engineers Search Engine Provides ACTUAL Data Instantly at minicircuits.com

Notes: 1. Performance and quality attributes and conditions not expressly stated in this specification sheet are intended to be excluded and do not form a part of this specification sheet. 2. Electrical specifications and performance data contained herein are based on Mini-Circuit's applicable established test performance criteria and measurement instructions. 3. The parts covered by this specification sheet are subject to Mini-Circuits standard limited warranty and terms and conditions (collectively, "Standard Terms"); Purchasers of this part are entitled to the rights and benefits contained therein. For a full statement of the Standard Terms and the exclusive rights and remedies thereunder, please visit Mini-Circuits' website at www.minicircuits.com/MCLStore/terms.jsp.

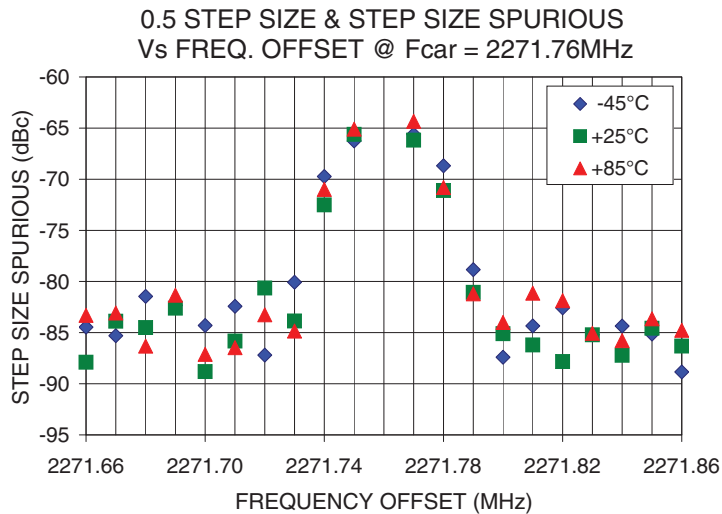
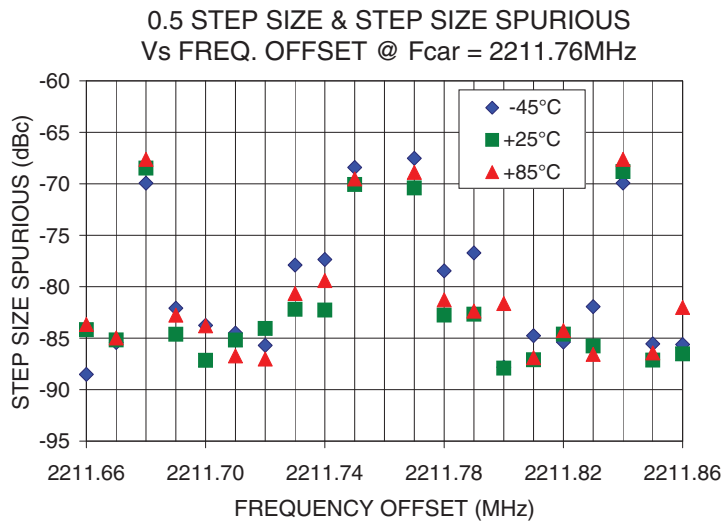
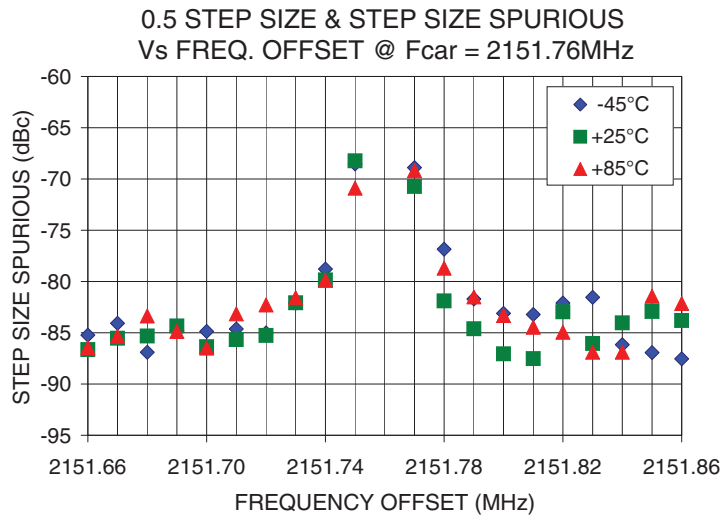

Pin Configuration

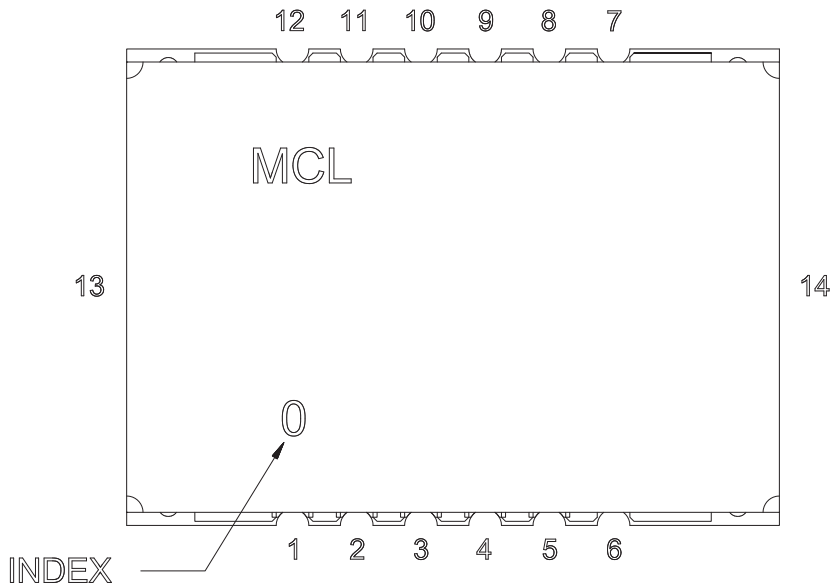

Pin Connection

Pin Number	Function
1	VCC PLL
2	GND
3	REF IN
4	GND
5	VCC VCO
6	GND
7	RF OUT
8	GND
9	LOCK DET
10	CLOCK
11	DATA
12	LE
13	GND
14	GND

Recommended Application Circuit

Note: REF IN and RF OUT ports are internally AC coupled.

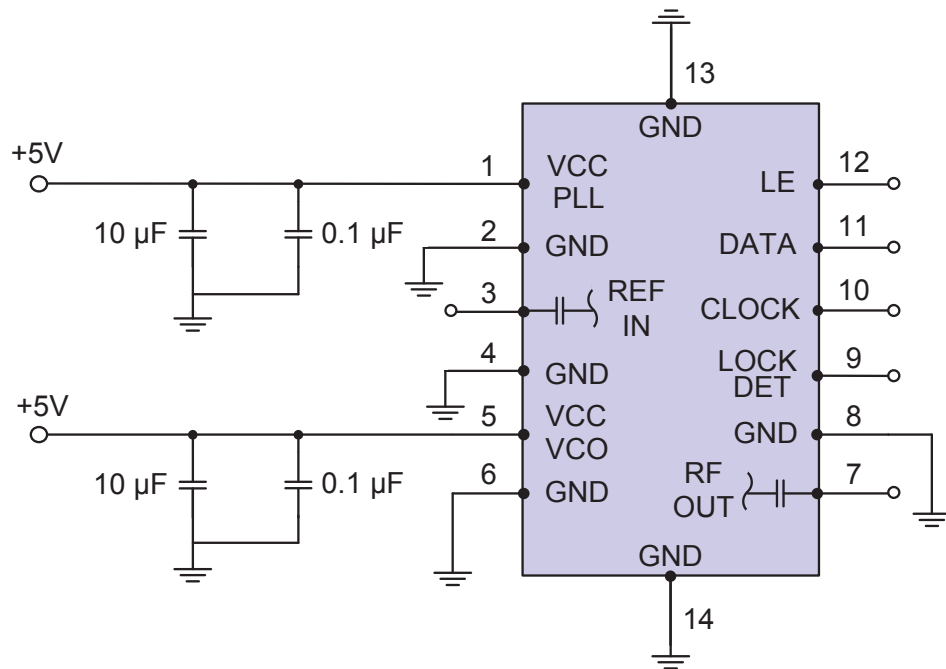

Device Marking

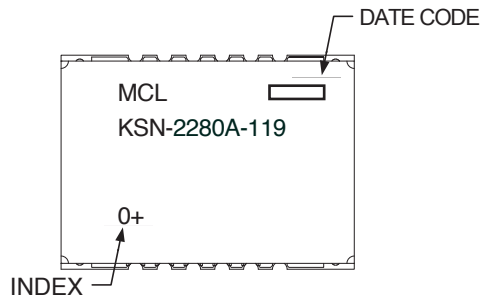

Additional Detailed Technical Information

Additional information is available on our web site. To access this information enter the model number on our web site home page.

Case Style: DK1042

Tape & Reel: TR-F28

Suggested Layout for PCB Design: PL-249

Evaluation Board: TB-567+

Environment Ratings: ENV03T2