

Surface Mount High Isolation Switch

KSWHA-1-20+

50Ω SPST, Absorptive DC⁴ to 2000 MHz

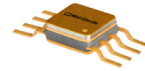

Generic photo used for illustration purposes only

CASE STYLE: XX112

Maximum Ratings

Operating Temperature	-55°C to 100°C
Storage Temperature	-55°C to 150°C
Input Power	see Table & Note1
Control Current	see Table

Permanent damage may occur if any of these limits are exceeded.

Pin Connections

RF IN	1
RF OUT	5
CONTROL 1	2
CONTROL 2	3
GROUND	4,6,7,8

Outline Drawing

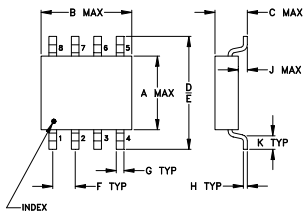

PCB Land Pattern

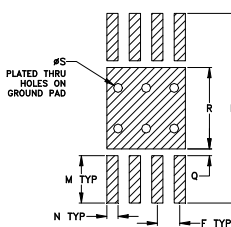

Suggested Layout,
Tolerance to be within ±0.02

Outline Dimensions (inch/mm)

A	B	C	D	E	F	G	H	
.180	.180	.070	.400	.350	.050	.015	.005	
4.57	4.57	1.78	10.16	8.89	1.27	0.38	0.13	
J	K	M	N	P	Q	R	S	wt.
.005	.070	.105	.025	.420	.015	.180	.020	grams
0.13	1.78	2.67	0.64	10.67	0.38	4.57	0.51	0.15

Demo Board MCL P/N: TB-206
Suggested PCB Layout (PL-218)

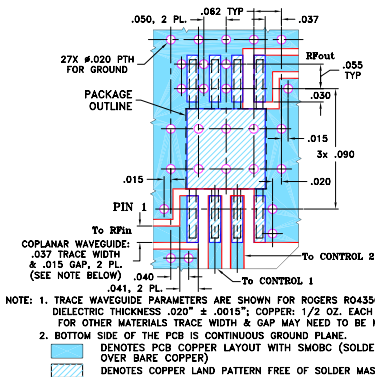

Notes

- Performance and quality attributes and conditions not expressly stated in this specification document are intended to be excluded and do not form a part of this specification document.
- Electrical specifications and performance data contained in this specification document are based on Mini-Circuit's applicable established test performance criteria and measurement instructions.
- The parts covered by this specification document are subject to Mini-Circuits standard limited warranty and terms and conditions (collectively, "Standard Terms"); Purchasers of this part are entitled to the rights and benefits contained therein. For a full statement of the Standard Terms and the exclusive rights and remedies thereunder, please visit Mini-Circuits' website at www.minicircuits.com/WCLStore/terms.jsp

Features

- wideband, DC to 2000 MHz
- low insertion loss, 1.3 dB typ.
- low video leakage, 30 mVp-p typ.
- hermetically sealed glass-metal package
- aqueous washable

Applications

- PCN
- cellular
- antenna switching

Electrical Specifications

Parameter	Condition (MHz)	Min	Typ.	Max	Units
Frequency ⁴		DC	-	2000	MHz
Insertion Loss	DC to 100 MHz	-	0.8	1.2	dB
	100 to 1000 MHz	-	1.3	1.7	
	1000 to 2000 MHz	-	1.3	1.7	
1dB Compression ¹	DC to 100 MHz	-	19	-	dBm
	100 to 1000 MHz	-	19	-	
	1000 to 2000 MHz	-	26	-	
Isolation (In to Out) ²	DC to 100 MHz	60	75	-	dB
	100 to 1000 MHz	58	65	-	
	1000 to 2000 MHz	58	65	-	
VSWR - RF IN and RF OUT (ON STATE)	DC to 200 MHz	-	-	1.25	: 1
	200 to 2000 MHz	-	-	1.5	
VSWR - RF IN (OFF STATE)	DC to 200 MHz	-	-	1.25	: 1
	200 to 2000 MHz	-	-	1.5	
VSWR - RF OUT (OFF STATE)	DC to 200 MHz	-	-	1.4	: 1
	200 to 2000 MHz	-	-	1.5	
Video Leakage ³		-	30	50	mV p-p
Rise / Fall Time	10 to 90%	-	3	5	nS
Switching Time – Turn On	50% Control to 90% RF	-	7	10	nS
		-	3	10	
Switching Time – Turn Off	50% Control to 10% RF	-	3	10	nS
		-	3	10	
Control Voltage (Vc)	Low	-0.2	-	0	V
	High	-8	-	-5	
Control Current	0 to -8V	-	-	200	μA
	-	-	-	-	
Max RF Input Power Steady State (not hot switching)	DC to 20 MHz	-	+23	-	dBm
	20 to 500 MHz	-	+30	-	
	500 to 2000 MHz	-	+33	-	
Max RF Input Power Hot Switching (as modulator)	DC to 20 MHz	-	+14.5	-	dBm
	20 to 500 MHz	-	+20	-	
	500 to 2000 MHz	-	+27	-	

CAUTION – IMPORTANT: RF PORTS MUST BE DC BLOCKED or HELD to 0V DC

1. 1dB Compression is specified at Control Voltage (Vc) = -8V
2. Isolation is specified RF IN to RF OUT with Control Logic = Off
3. Video leakage or breakthrough is defined as leakage of switching control signal to RF output port
4. All RF connections must be DC blocked or held at 0V DC.

Electrical Schematic

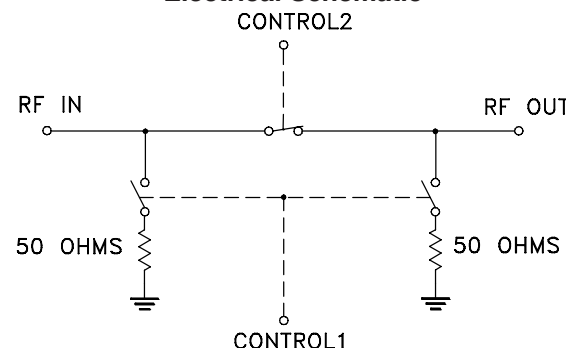

CONTROL LOGIC

Control Ports		RF outputs
1	2	On
-V	0	
0	-V	Off

Typical Performance Data

FREQ. (MHz)	ON INSERTION LOSS (dB) (ctrl1 @ -8V, ctrl 2 @ 0V) IN-OUT		OFF ISOLATION (dB) (ctrl 1 @ 0V, ctrl 2 @ -8V) IN-OUT		VSWR		
	\bar{x}	σ	\bar{x}	σ	\bar{x}	OUT	
						ON \bar{x}	OFF \bar{x}
0.30	0.62	0.01	90.61	3.68	1.15	1.15	1.03
5.30	0.63	0.01	85.48	6.29	1.16	1.15	1.03
10.30	0.69	0.01	83.23	4.25	1.16	1.15	1.03
100.29	0.79	0.01	67.92	1.22	1.15	1.15	1.03
280.26	0.85	0.01	66.96	1.83	1.15	1.14	1.03
390.24	0.92	0.00	67.09	1.35	1.15	1.14	1.03
445.23	0.90	0.01	67.05	1.41	1.16	1.15	1.03
610.21	0.96	0.01	65.89	1.85	1.16	1.15	1.04
780.18	0.99	0.01	64.48	1.97	1.17	1.16	1.05
890.17	1.02	0.01	63.58	2.32	1.18	1.16	1.06
945.16	1.04	0.01	63.07	2.05	1.18	1.16	1.07
1000.15	0.99	0.00	62.55	1.47	1.18	1.15	1.08
1165.13	1.09	0.02	61.49	2.35	1.18	1.15	1.09
1335.10	1.11	0.02	61.45	1.70	1.17	1.14	1.12
1445.08	1.14	0.02	61.66	1.64	1.16	1.13	1.13
1500.08	1.09	0.02	62.32	2.10	1.16	1.12	1.14
1665.05	1.17	0.01	60.72	1.78	1.15	1.10	1.17
1835.03	1.13	0.01	60.34	0.70	1.14	1.07	1.20
1945.01	1.22	0.03	60.54	1.60	1.13	1.06	1.22
2000.00	1.17	0.01	61.08	1.47	1.13	1.05	1.23

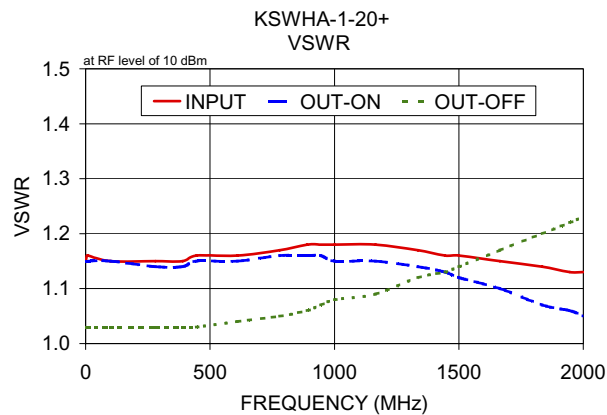
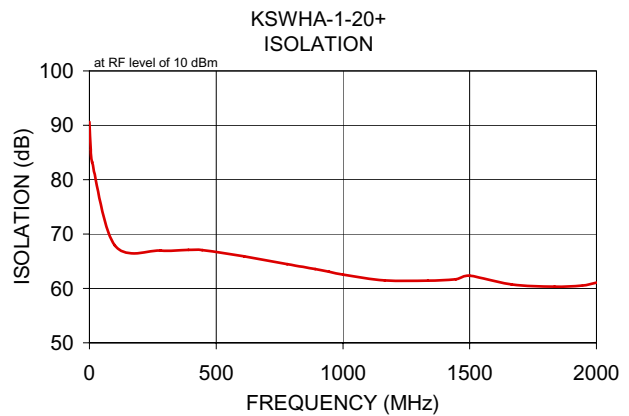
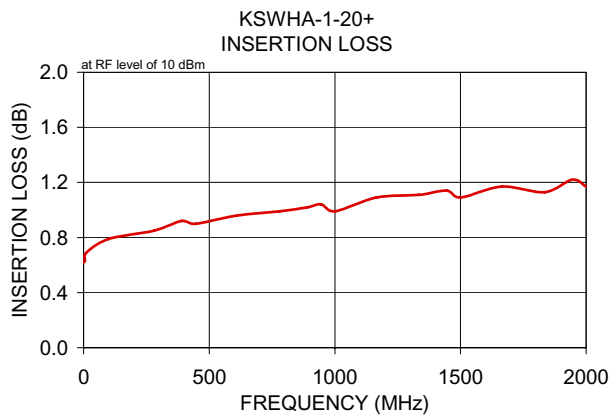

Notes

- A. Performance and quality attributes and conditions not expressly stated in this specification document are intended to be excluded and do not form a part of this specification document.
- B. Electrical specifications and performance data contained in this specification document are based on Mini-Circuit's applicable established test performance criteria and measurement instructions.
- C. The parts covered by this specification document are subject to Mini-Circuits standard limited warranty and terms and conditions (collectively, "Standard Terms"); Purchasers of this part are entitled to the rights and benefits contained therein. For a full statement of the Standard Terms and the exclusive rights and remedies thereunder, please visit Mini-Circuits' website at www.minicircuits.com/MCLStore/terms.jsp

