

## Frequency Synthesizer

RSN-749AF+

50Ω 714 to 749 MHz

### The Big Deal

- Fractional N synthesizer
- Fast settling time, 0.04 msec max
- Low phase noise and spurious
- High reliability over temperature changes
- Small size 0.910" x 0.910" x 0.252"



CASE STYLE: JG1228

### Product Overview

The RSN-749AF+ is a Frequency Synthesizer, designed to operate from 714 to 749 MHz for GSM application. The RSN-749AF+ is packaged in a metal case (size of 0.910" x 0.910" x 0.252") to shield against unwanted signals and noise. The RSN-749AF+ Frequency Synthesizer can be used as local oscillators in the upconversion and down-conversion sections of wireless receivers and transmitters, with very high reliability over temperature changes due to use of high quality components which are secured to substrate with chip adhesive in addition to solder

### Key Features

Feature	Advantages
Low phase noise and spurious: <ul style="list-style-type: none"> <li>• Phase Noise: -104 dBc/Hz typ. @ 10 kHz offset</li> <li>• Step Size Spurious: -78 dBc typ.</li> <li>• Comparison Spurious: -111 dBc typ.</li> <li>• Reference Spurious: -103 dBc typ.</li> </ul>	Low phase noise and spurious improve system EVM (Error Vector Magnitude).
Fast settling time	Less than 0.04 msec Max within 5 deg can be used for fast settling applications.
Small size, 0.910" x 0.910" x 0.252"	The small size enables the RSN-749AF+ to be used in compact designs.



IF/RF MICROWAVE COMPONENTS • ISO 9001 ISO 14001 AS9100 CERTIFIED RoHS compliant  
 P.O. Box 350166, Brooklyn, New York 11235-0003 (718) 934-4500 Fax (718) 332-4661



The Design Engineers Search Engine finds the model you need, Instantly • For detailed performance specs & shopping online see



Notes: 1. Performance and quality attributes and conditions not expressly stated in this specification sheet are intended to be excluded and do not form a part of this specification sheet. 2. Electrical specifications and performance data contained herein are based on Mini-Circuit's applicable established test performance criteria and measurement instructions. 3. The parts covered by this specification sheet are subject to Mini-Circuits standard limited warranty and terms and conditions (collectively, "Standard Terms"); Purchasers of this part are entitled to the rights and benefits contained therein. For a full statement of the Standard Terms and the exclusive rights and remedies thereunder, please visit Mini-Circuits' website at [www.minicircuits.com/MCLStore/terms.jsp](http://www.minicircuits.com/MCLStore/terms.jsp).

50Ω 714 to 749 MHz

### Features

- Fractional N synthesizer
- Fast settling time, 0.04 msec max
- Low phase noise and spurious
- High reliability over temperature changes
- Low operating voltage  
(VCC VCO=+5.5V, VCC PLL=+3.3V, VCC CP=+5.0V)
- Small size 0.910" x 0.910" x 0.252"



CASE STYLE: JG1228

+ RoHS compliant in accordance with EU Directive (2002/95/EC)

The +Suffix has been added in order to identify RoHS Compliance. See our web site for RoHS Compliance methodologies and qualifications.

### Applications

- GSM

### General Description

The RSN-749AF+ is a Frequency Synthesizer, designed to operate from 714 to 749 MHz for GSM application. The RSN-749AF+ is packaged in a metal case (size of 0.910" x 0.910" x 0.252") to shield against unwanted signals and noise. The RSN-749AF+ Frequency Synthesizer can be used as local oscillators in the upconversion and down-conversion sections of wireless receivers and transmitters, with very high reliability over temperature changes due to use of high quality components which are secured to substrate with chip adhesive in addition to solder.

### Simplified Schematic

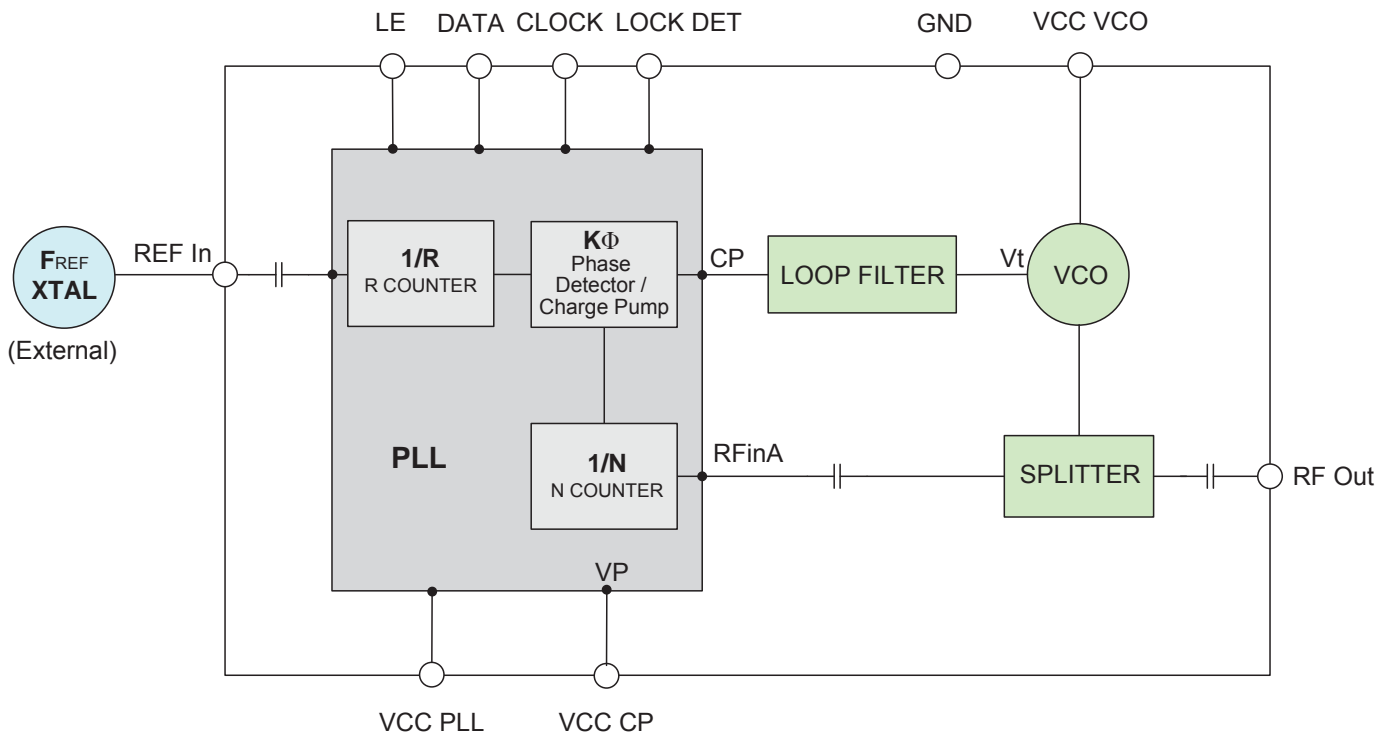

IF/RF MICROWAVE COMPONENTS • ISO 9001 ISO 14001 AS9100 CERTIFIED RoHS compliant  
P.O. Box 350166, Brooklyn, New York 11235-0003 (718) 934-4500 Fax (718) 332-4661



The Design Engineers Search Engine finds the model you need, Instantly • For detailed performance specs & shopping online see [minicircuits.com](http://minicircuits.com)

Notes: 1. Performance and quality attributes and conditions not expressly stated in this specification sheet are intended to be excluded and do not form a part of this specification sheet. 2. Electrical specifications and performance data contained herein are based on Mini-Circuit's applicable established test performance criteria and measurement instructions. 3. The parts covered by this specification sheet are subject to Mini-Circuits standard limited warranty and terms and conditions (collectively, "Standard Terms"); Purchasers of this part are entitled to the rights and benefits contained therein. For a full statement of the Standard Terms and the exclusive rights and remedies thereunder, please visit Mini-Circuits' website at [www.minicircuits.com/MCLStore/terms.jsp](http://www.minicircuits.com/MCLStore/terms.jsp).



### Electrical Specifications (over operating temperature -40°C to +85°C)

Parameters	Test Conditions	Min.	Typ.	Max.	Units
Frequency Range	-	714	-	749	MHz
Step Size	-	-	200	-	kHz
Comparison Frequency	-	-	13	-	MHz
Settling Time	Within ± 5 deg	-	0.025	0.040	mSec
Output Power	-	+2	+5	+8	dBm
SSB Phase Noise	@ 100 Hz offset	-	-91	-	dBc/Hz
	@ 1 kHz offset	-	-101	-96	
	@ 10 kHz offset	-	-104	-100	
	@ 100 kHz offset	-	-106	-101	
	@ 1 MHz offset	-	-151	-146	
Integrated SSB Phase Noise	@ 100 Hz to 1 MHz	-	-51	-	dBc
Step Size Spurious Suppression	Step Size 200 kHz	-	-78	-63	dBc
0.5 Step Size Spurious Suppression	0.5 Step Size 100 kHz	-	-80	-65	
Reference Spurious Suppression	Ref. Freq. 52 MHz	-	-103	-85	
Comparison Spurious Suppression	Comp. Freq. 13 MHz	-	-111	-81	
Non - Harmonic Spurious Suppression	-	-	-90	-	
Harmonic Suppression	-	-	-22	-15	V
VCO Supply Voltage	+5.50	+5.20	+5.50	+5.80	
PLL Supply Voltage	+3.30	+3.15	+3.30	+3.45	
CP Supply Voltage	+5.00	+4.80	+5.00	+5.20	
VCO Supply Current	-	-	74	83	mA
PLL Supply Current	-	-	23	31	
CP Supply Current	-	-	20	25	
Reference Input (External)	Frequency	52 (square wave)	-	52	MHz
	Amplitude	1	-	1	V <sub>PP</sub>
	Input impedance	-	-	100	KΩ
	Phase Noise @ 1 kHz offset	-	-	-135	dBc/Hz
RF Output port Impedance	-	-	50	-	Ω
Input Logic Level	Input high voltage	-	2.80	-	V
	Input low voltage	-	-	0.60	V
Digital Lock Detect	Locked	-	2.75	-	V
	Unlocked	-	-	0.40	V
Frequency Synthesizer PLL	-	ADF4193			
PLL Programming (Note*)	-	3-wire serial 3.3V CMOS			
Register Map @ 749 MHz	R0_Register	-	(MSB) 111001000000101000000 (LSB)		
	R1_Register	-	(MSB) 10000001000001001 (LSB)		
	R2_Register	-	(MSB) 10 (LSB)		
	R3_Register	-	(MSB) 1111011 (LSB)		
	R4_Register	-	(MSB) 100001110010100 (LSB)		
	R5_Register	-	(MSB) 101 (LSB)		
	R6_Register	-	(MSB) 1001000000001110 (LSB)		
	R7_Register	-	(MSB) 111 (LSB)		

**Note\*** : Tested with GSM900RX\_13M\_PHASE CODE (GSM900/GSM850 RX, version 1.0) from "Analog Devices" recommendation for ADF4193 PLL.

[Download Phase Code file](#)

### Absolute Maximum Ratings

Parameters	Ratings
VCO Supply Voltage	+6.3V
PLL Supply Voltage	+3.6V
CP Supply Voltage	+5.8V
CP Supply Voltage to PLL Supply Voltage	-0.3V to 5.8V
Reference Frequency Voltage	-0.3Vmin, VCC PLL +0.3Vmax
Data, Clock, LE Levels	-0.3Vmin, VCC PLL +0.3Vmax
Operating Temperature	-40°C to +85°C
Storage Temperature	-55°C to +100°C

Permanent damage may occur if any of these limits are exceeded



IF/RF MICROWAVE COMPONENTS • ISO 9001 ISO 14001 AS9100 CERTIFIED RoHS compliant

P.O. Box 350166, Brooklyn, New York 11235-0003 (718) 934-4500 Fax (718) 332-4661



The Design Engineers Search Engine finds the model you need, Instantly • For detailed performance specs & shopping online see



Notes: 1. Performance and quality attributes and conditions not expressly stated in this specification sheet are intended to be excluded and do not form a part of this specification sheet. 2. Electrical specifications and performance data contained herein are based on Mini-Circuit's applicable established test performance criteria and measurement instructions. 3. The parts covered by this specification sheet are subject to Mini-Circuits standard limited warranty and terms and conditions (collectively, "Standard Terms"); Purchasers of this part are entitled to the rights and benefits contained therein. For a full statement of the Standard Terms and the exclusive rights and remedies thereunder, please visit Mini-Circuits' website at [www.minicircuits.com/MCLStore/terms.jsp](http://www.minicircuits.com/MCLStore/terms.jsp).

# NON-CATALOG

Frequency Synthesizer

RSN-749AF+

## Typical Performance Data

FREQUENCY (MHz)	POWER OUTPUT (dBm)			VCO CURRENT (mA)			PLL CURENT (mA)			CP CURENT (mA)		
	-45°C	+25°C	+85°C	-45°C	+25°C	+85°C	-45°C	+25°C	+85°C	-45°C	+25°C	+85°C
	714	5.06	4.55	3.17	72.67	75.65	77.68	21.25	24.00	26.24	20.00	20.12
717	5.21	4.56	3.19	72.59	75.55	77.57	21.82	24.30	26.85	20.00	20.12	20.25
723	5.27	4.61	3.24	72.40	75.34	77.37	21.54	24.32	26.35	20.00	20.12	20.23
729	5.32	4.68	3.31	72.21	75.14	77.15	21.77	24.52	26.68	20.00	20.12	20.24
735	5.40	4.75	3.37	71.99	74.90	76.92	21.50	24.25	26.50	20.00	20.12	20.24
741	5.52	4.80	3.41	71.74	74.63	76.67	21.53	24.29	26.61	20.00	20.11	20.25
747	5.57	4.82	3.42	71.44	74.34	76.42	21.64	24.32	26.76	20.00	20.12	20.26
749	5.56	4.82	3.41	71.34	74.25	76.34	21.45	24.22	26.71	20.00	20.11	20.26

FREQUENCY (MHz)	HARMONICS (dBc)					
	F2			F3		
	-45°C	+25°C	+85°C	-45°C	+25°C	+85°C
714	-24.88	-22.16	-18.87	-42.93	-40.34	-40.90
717	-25.08	-22.22	-18.93	-43.22	-40.38	-40.83
723	-24.99	-22.08	-18.76	-43.37	-40.18	-40.54
729	-25.10	-22.08	-18.72	-43.33	-40.18	-40.37
735	-25.36	-22.13	-18.69	-42.43	-39.26	-39.53
741	-25.63	-22.13	-18.63	-42.99	-39.80	-39.88
747	-26.20	-22.58	-19.02	-42.53	-39.60	-39.56
749	-26.41	-22.76	-19.21	-42.68	-39.67	-39.58



IF/RF MICROWAVE COMPONENTS • ISO 9001 ISO 14001 AS9100 CERTIFIED RoHS compliant  
P.O. Box 350166, Brooklyn, New York 11235-0003 (718) 934-4500 Fax (718) 332-4661



The Design Engineers Search Engine finds the model you need, Instantly • For detailed performance specs & shopping online see



Notes: 1. Performance and quality attributes and conditions not expressly stated in this specification sheet are intended to be excluded and do not form a part of this specification sheet. 2. Electrical specifications and performance data contained herein are based on Mini-Circuit's applicable established test performance criteria and measurement instructions. 3. The parts covered by this specification sheet are subject to Mini-Circuits standard limited warranty and terms and conditions (collectively, "Standard Terms"); Purchasers of this part are entitled to the rights and benefits contained therein. For a full statement of the Standard Terms and the exclusive rights and remedies thereunder, please visit Mini-Circuits' website at [www.minicircuits.com/MCLStore/terms.jsp](http://www.minicircuits.com/MCLStore/terms.jsp).

# NON-CATALOG

## Frequency Synthesizer

## RSN-749AF+

FREQUENCY (MHz)	PHASE NOISE (dBc/Hz) @OFFSETS				
	+25°C				
	100Hz	1kHz	10kHz	100kHz	1MHz
714	-96.23	-102.20	-105.41	-105.55	-152.78
717	-94.45	-100.75	-104.92	-105.74	-152.70
723	-95.37	-101.95	-104.56	-105.83	-152.37
729	-95.71	-101.43	-104.80	-106.21	-152.28
735	-95.47	-101.73	-104.65	-106.62	-151.61
741	-93.72	-102.29	-103.94	-107.42	-151.00
747	-96.84	-101.60	-104.15	-107.49	-149.40
749	-95.42	-101.67	-104.66	-107.52	-150.17

FREQUENCY (MHz)	PHASE NOISE (dBc/Hz) @OFFSETS				
	-45°C				
	100Hz	1kHz	10kHz	100kHz	1MHz
714	-95.03	-100.91	-104.67	-106.13	-153.58
717	-94.23	-101.53	-104.57	-106.21	-153.85
723	-94.99	-99.42	-103.75	-106.57	-153.37
729	-92.80	-100.20	-103.83	-106.80	-153.54
735	-93.52	-101.26	-104.00	-107.08	-152.74
741	-94.21	-99.90	-103.76	-107.92	-152.14
747	-93.23	-100.44	-103.77	-107.98	-150.62
749	-93.90	-101.35	-103.96	-108.05	-150.57

FREQUENCY (MHz)	PHASE NOISE (dBc/Hz) @OFFSETS				
	+85°C				
	100Hz	1kHz	10kHz	100kHz	1MHz
714	-97.25	-102.55	-105.32	-104.93	-151.88
717	-97.28	-102.09	-104.61	-105.01	-151.89
723	-97.46	-102.01	-104.66	-105.18	-151.90
729	-98.29	-101.11	-104.26	-105.54	-152.02
735	-97.70	-101.06	-104.57	-105.77	-151.94
741	-95.17	-100.62	-103.51	-106.42	-152.01
747	-96.36	-102.04	-104.43	-106.45	-151.97
749	-96.91	-101.88	-104.00	-106.56	-151.28



IF/RF MICROWAVE COMPONENTS • ISO 9001 ISO 14001 AS9100 CERTIFIED RoHS compliant  
P.O. Box 350166, Brooklyn, New York 11235-0003 (718) 934-4500 Fax (718) 332-4661



The Design Engineers Search Engine finds the model you need, Instantly • For detailed performance specs & shopping online see



Notes: 1. Performance and quality attributes and conditions not expressly stated in this specification sheet are intended to be excluded and do not form a part of this specification sheet. 2. Electrical specifications and performance data contained herein are based on Mini-Circuit's applicable established test performance criteria and measurement instructions. 3. The parts covered by this specification sheet are subject to Mini-Circuits standard limited warranty and terms and conditions (collectively, "Standard Terms"); Purchasers of this part are entitled to the rights and benefits contained therein. For a full statement of the Standard Terms and the exclusive rights and remedies thereunder, please visit Mini-Circuits' website at [www.minicircuits.com/MCLStore/terms.jsp](http://www.minicircuits.com/MCLStore/terms.jsp).

# NON-CATALOG

## Frequency Synthesizer

## RSN-749AF+

COMPARISON SPURIOUS ORDER	COMPARISON SPURIOUS @Fcarrier 714MHz+(n*Fcomparison) (dBc) note 1			COMPARISON SPURIOUS @Fcarrier 731.4MHz+(n*Fcomparison) (dBc) note 1			COMPARISON SPURIOUS @Fcarrier 749MHz+(n*Fcomparison) (dBc) note 1			
	n	-45°C	+25°C	+85°C	-45°C	+25°C	+85°C	-45°C	+25°C	+85°C
	-5	-116.83	-120.84	-115.56	-116.53	-122.93	-117.67	-116.98	-125.57	-120.82
-4	-115.25	-122.89	-116.69	-119.48	-123.12	-117.53	-118.53	-123.86	-119.99	
-3	-124.80	-125.47	-118.83	-124.01	-125.67	-119.67	-120.90	-127.76	-120.80	
-2	-118.19	-119.90	-113.53	-120.50	-124.15	-113.74	-118.74	-124.90	-117.38	
-1	-113.91	-113.76	-111.12	-118.56	-119.40	-108.72	-112.79	-122.97	-114.01	
0 note 2	-	-	-	-	-	-	-	-	-	
+1	-114.81	-111.48	-115.09	-117.14	-116.46	-110.83	-112.57	-125.24	-114.89	
+2	-117.33	-114.84	-125.69	-117.84	-119.60	-118.65	-120.39	-128.24	-125.62	
+3	-119.62	-120.82	-127.70	-121.18	-122.68	-119.14	-118.77	-126.05	-124.55	
+4	-116.73	-116.33	-123.58	-119.22	-118.38	-124.71	-119.85	-125.37	-126.72	
+5	-115.18	-114.09	-115.93	-118.50	-115.82	-116.88	-115.98	-117.03	-119.34	

Note 1: Comparison frequency 13 MHz

Note 2: All spurs are referenced to carrier signal (n=0).

REFERENCE SPURIOUS ORDER	REFERENCE SPURIOUS @Fcarrier 714MHz+(n*Freference) (dBc) note 3			REFERENCE SPURIOUS @Fcarrier 731.4MHz+(n*Freference) (dBc) note 3			REFERENCE SPURIOUS @Fcarrier 749MHz+(n*Freference) (dBc) note 3			
	n	-45°C	+25°C	+85°C	-45°C	+25°C	+85°C	-45°C	+25°C	+85°C
	-5	-124.46	-125.07	-126.21	-123.80	-124.54	-124.72	-119.68	-125.75	-126.40
-4	-125.93	-126.18	-126.06	-124.26	-125.68	-126.02	-125.99	-125.25	-125.41	
-3	-125.89	-120.35	-121.32	-126.14	-119.15	-119.63	-122.14	-118.56	-118.93	
-2	-108.05	-103.21	-101.39	-111.98	-107.38	-105.11	-116.03	-111.35	-107.77	
-1	-119.19	-122.01	-117.83	-123.88	-121.73	-116.94	-127.52	-123.68	-120.51	
0 note 4	-	-	-	-	-	-	-	-	-	
+1	-116.03	-117.06	-121.54	-118.12	-120.31	-124.77	-121.34	-125.78	-128.21	
+2	-104.25	-106.75	-105.40	-109.06	-110.44	-108.20	-113.20	-115.62	-112.28	
+3	-124.12	-117.85	-119.07	-120.65	-118.43	-121.81	-121.49	-119.82	-121.63	
+4	-125.61	-129.99	-128.63	-124.56	-126.75	-124.92	-126.31	-126.35	-122.36	
+5	-126.59	-130.42	-129.86	-127.63	-124.22	-130.49	-128.71	-131.00	-127.02	

Note 3: Reference frequency 52 MHz

Note 4: All spurs are referenced to carrier signal (n=0).



IF/RF MICROWAVE COMPONENTS • ISO 9001 ISO 14001 AS9100 CERTIFIED RoHS compliant  
P.O. Box 350166, Brooklyn, New York 11235-0003 (718) 934-4500 Fax (718) 332-4661



The Design Engineers Search Engine finds the model you need, Instantly • For detailed performance specs & shopping online see



Notes: 1. Performance and quality attributes and conditions not expressly stated in this specification sheet are intended to be excluded and do not form a part of this specification sheet. 2. Electrical specifications and performance data contained herein are based on Mini-Circuit's applicable established test performance criteria and measurement instructions. 3. The parts covered by this specification sheet are subject to Mini-Circuits standard limited warranty and terms and conditions (collectively, "Standard Terms"); Purchasers of this part are entitled to the rights and benefits contained therein. For a full statement of the Standard Terms and the exclusive rights and remedies thereunder, please visit Mini-Circuits' website at [www.minicircuits.com/MCLStore/terms.jsp](http://www.minicircuits.com/MCLStore/terms.jsp).

# NON-CATALOG

## Frequency Synthesizer

## RSN-749AF+

STEP SIZE SPURIOUS ORDER  n	0.5 STEP SIZE & STEP SIZE SPURIOUS @Fcarrier 714MHz+(n*Fstep size) (dBc) note 5			0.5 STEP SIZE & STEP SIZE SPURIOUS @Fcarrier 731.4MHz+(n*Fstep size) (dBc) note 5			0.5 STEP SIZE & STEP SIZE SPURIOUS @Fcarrier 749MHz+(n*Fstep size) (dBc) note 5		
	-45°C	+25°C	+85°C	-45°C	+25°C	+85°C	-45°C	+25°C	+85°C
-5.0	-107.94	-97.89	-92.75	-114.20	-118.44	-103.16	-118.66	-117.94	-115.14
-4.5	-118.28	-117.51	-118.25	-116.62	-116.36	-116.42	-117.82	-120.10	-118.82
-4.0	-100.47	-105.39	-108.87	-108.39	-108.03	-105.63	-112.51	-105.81	-106.54
-3.5	-115.46	-116.41	-113.74	-110.21	-116.85	-114.85	-118.31	-115.95	-117.04
-3.0	-100.97	-97.24	-96.79	-99.85	-96.84	-110.17	-111.24	-94.42	-95.97
-2.5	-111.34	-108.73	-109.58	-111.63	-110.60	-111.66	-112.11	-112.79	-107.94
-2.0	-90.50	-93.41	-90.77	-89.97	-90.47	-89.40	-95.98	-86.14	-91.12
-1.5	-103.63	-99.71	-103.58	-101.70	-101.61	-103.90	-105.27	-105.90	-100.37
-1.0	-80.27	-75.11	-86.13	-76.96	-78.45	-77.38	-72.98	-72.64	-81.26
-0.5	-82.00	-80.29	-77.96	-80.57	-82.14	-77.56	-82.54	-84.57	-82.79
0 <sup>note 6</sup>	-	-	-	-	-	-	-	-	-
+0.5	-76.86	-82.58	-82.85	-80.01	-78.94	-84.42	-83.81	-84.22	-86.10
+1.0	-82.05	-75.46	-86.96	-77.02	-79.04	-77.50	-73.20	-72.70	-80.49
+1.5	-101.16	-102.72	-102.07	-100.59	-104.48	-104.47	-104.87	-99.38	-99.66
+2.0	-92.86	-94.67	-89.61	-89.61	-90.29	-89.24	-96.36	-86.42	-89.63
+2.5	-107.90	-110.25	-112.31	-108.43	-111.53	-112.08	-109.55	-113.88	-111.47
+3.0	-101.85	-97.23	-96.52	-101.13	-96.33	-110.85	-112.32	-93.82	-95.59
+3.5	-117.91	-113.51	-113.08	-114.10	-109.36	-113.91	-117.45	-116.60	-113.90
+4.0	-100.04	-105.66	-111.24	-108.64	-109.25	-106.44	-112.24	-105.17	-107.64
+4.5	-118.86	-117.90	-120.15	-109.27	-106.82	-108.45	-115.10	-117.58	-116.83
+5.0	-108.15	-97.50	-92.75	-114.17	-116.93	-102.32	-118.44	-115.39	-116.23

Note 5: Step size 200 kHz

Note 6: All spurs are referenced to carrier signal (n=0).



IF/RF MICROWAVE COMPONENTS • ISO 9001 ISO 14001 AS9100 CERTIFIED RoHS compliant

P.O. Box 350166, Brooklyn, New York 11235-0003 (718) 934-4500 Fax (718) 332-4661



The Design Engineers Search Engine finds the model you need, Instantly • For detailed performance specs & shopping online see



Notes: 1. Performance and quality attributes and conditions not expressly stated in this specification sheet are intended to be excluded and do not form a part of this specification sheet. 2. Electrical specifications and performance data contained herein are based on Mini-Circuit's applicable established test performance criteria and measurement instructions. 3. The parts covered by this specification sheet are subject to Mini-Circuits standard limited warranty and terms and conditions (collectively, "Standard Terms"); Purchasers of this part are entitled to the rights and benefits contained therein. For a full statement of the Standard Terms and the exclusive rights and remedies thereunder, please visit Mini-Circuits' website at [www.minicircuits.com/MCLStore/terms.jsp](http://www.minicircuits.com/MCLStore/terms.jsp).

### Typical Performance Curves

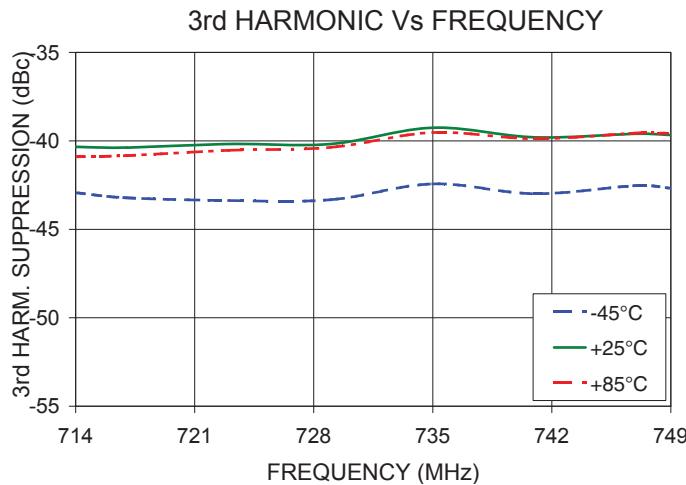
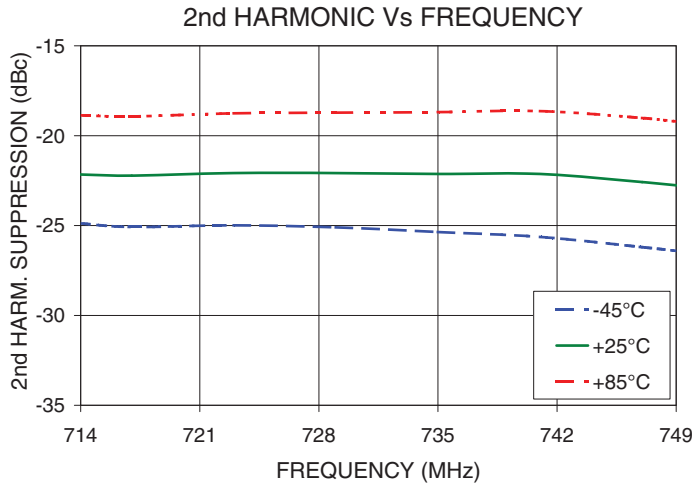
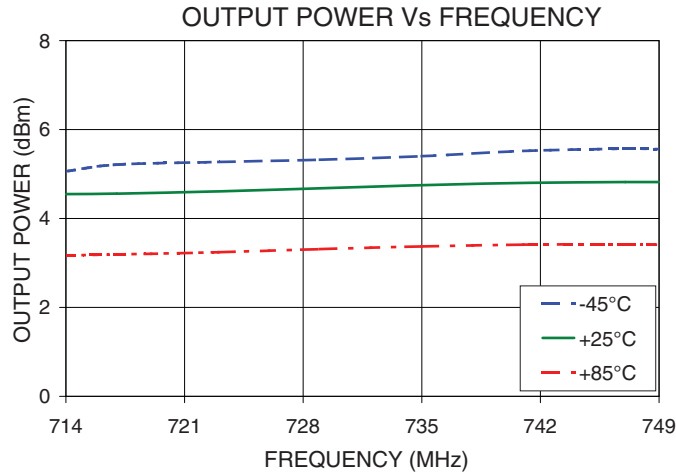

IF/RF MICROWAVE COMPONENTS • ISO 9001 ISO 14001 AS9100 CERTIFIED RoHS compliant  
 P.O. Box 350166, Brooklyn, New York 11235-0003 (718) 934-4500 Fax (718) 332-4661



The Design Engineers Search Engine finds the model you need, Instantly • For detailed performance specs & shopping online see



Notes: 1. Performance and quality attributes and conditions not expressly stated in this specification sheet are intended to be excluded and do not form a part of this specification sheet. 2. Electrical specifications and performance data contained herein are based on Mini-Circuit's applicable established test performance criteria and measurement instructions. 3. The parts covered by this specification sheet are subject to Mini-Circuits standard limited warranty and terms and conditions (collectively, "Standard Terms"); Purchasers of this part are entitled to the rights and benefits contained therein. For a full statement of the Standard Terms and the exclusive rights and remedies thereunder, please visit Mini-Circuits' website at [www.minicircuits.com/MCLStore/terms.jsp](http://www.minicircuits.com/MCLStore/terms.jsp).



# NON-CATALOG

## Frequency Synthesizer

## RSN-749AF+

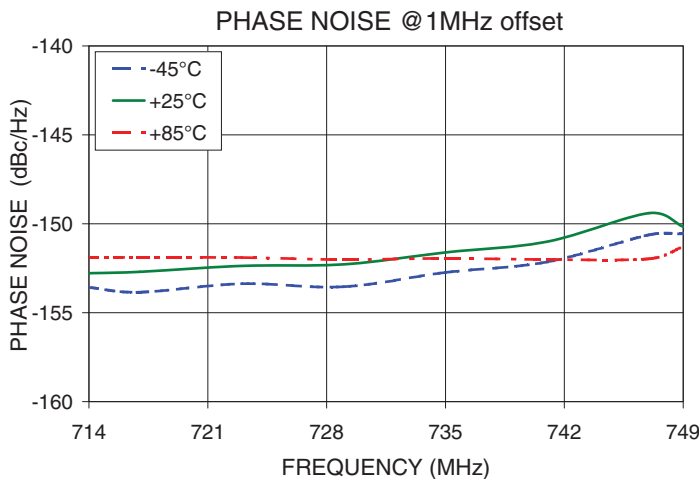
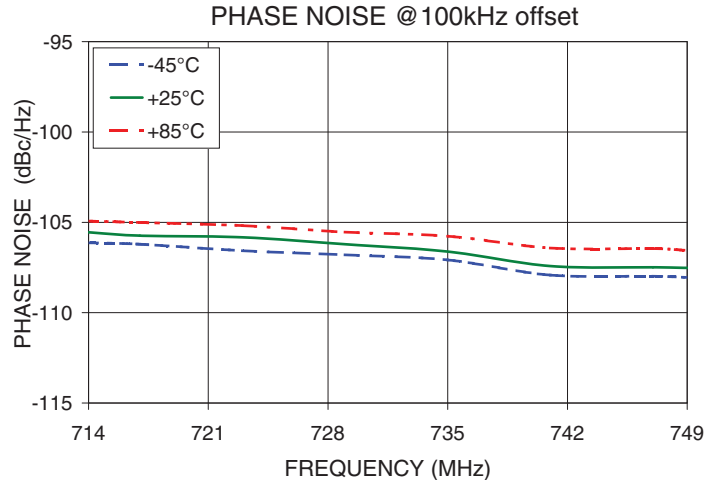
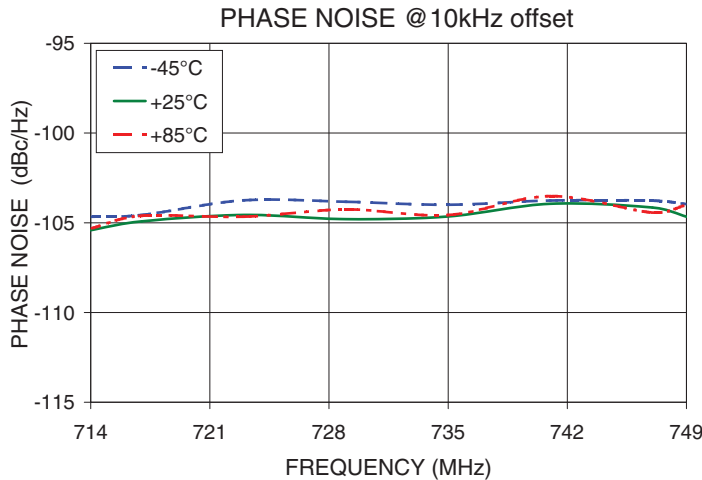
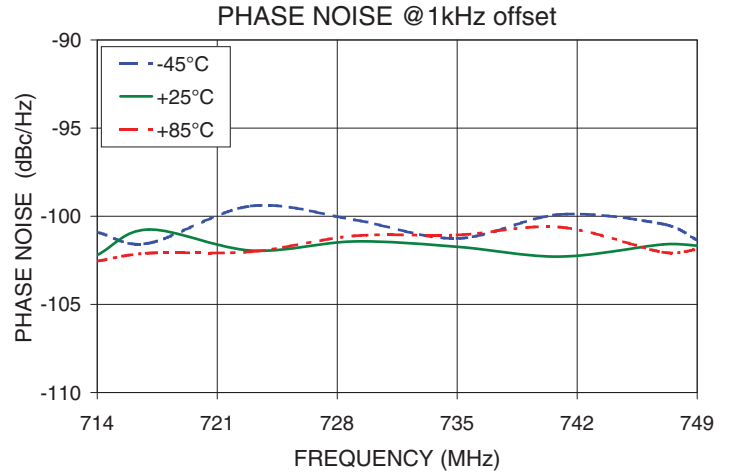
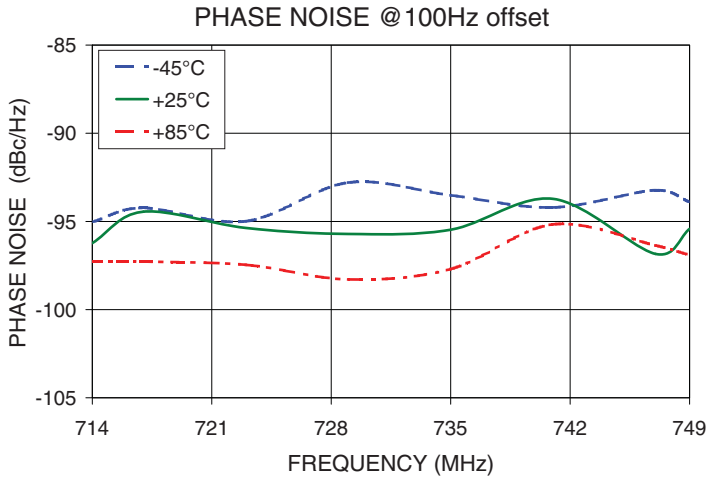

IF/RF MICROWAVE COMPONENTS • ISO 9001 ISO 14001 AS9100 CERTIFIED RoHS compliant  
 P.O. Box 350166, Brooklyn, New York 11235-0003 (718) 934-4500 Fax (718) 332-4661



The Design Engineers Search Engine finds the model you need, Instantly • For detailed performance specs & shopping online see



Notes: 1. Performance and quality attributes and conditions not expressly stated in this specification sheet are intended to be excluded and do not form a part of this specification sheet. 2. Electrical specifications and performance data contained herein are based on Mini-Circuit's applicable established test performance criteria and measurement instructions. 3. The parts covered by this specification sheet are subject to Mini-Circuits standard limited warranty and terms and conditions (collectively, "Standard Terms"); Purchasers of this part are entitled to the rights and benefits contained therein. For a full statement of the Standard Terms and the exclusive rights and remedies thereunder, please visit Mini-Circuits' website at [www.minicircuits.com/MCLStore/terms.jsp](http://www.minicircuits.com/MCLStore/terms.jsp).

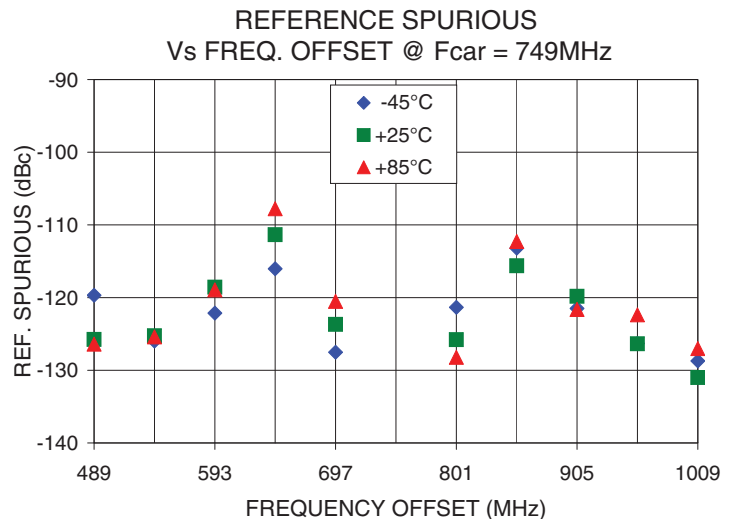
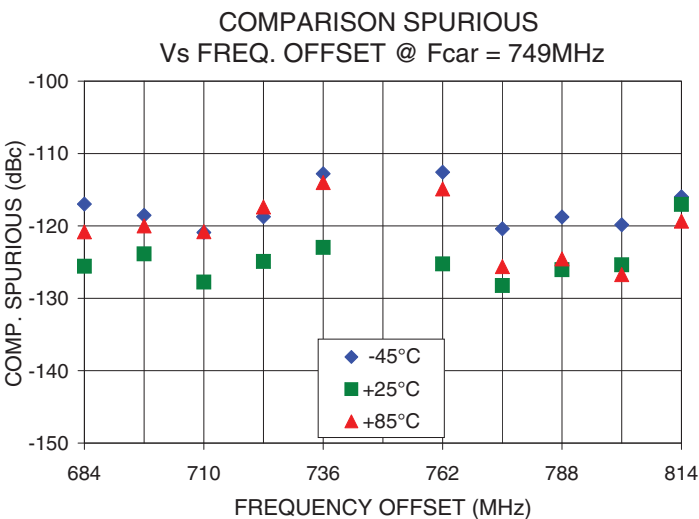
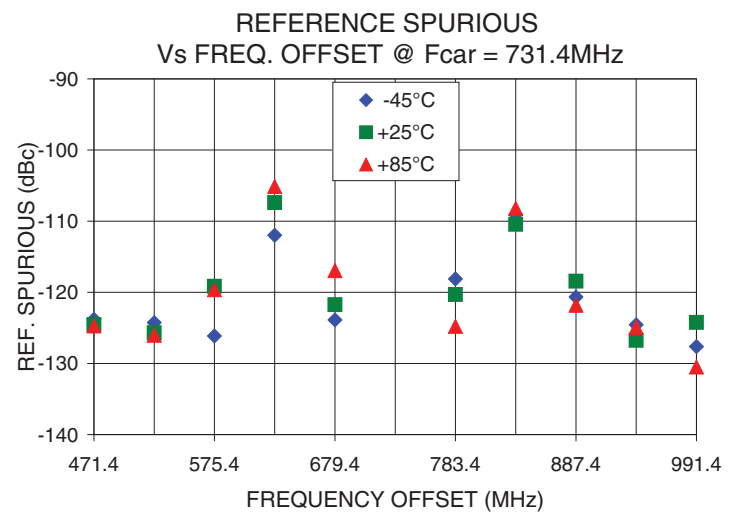
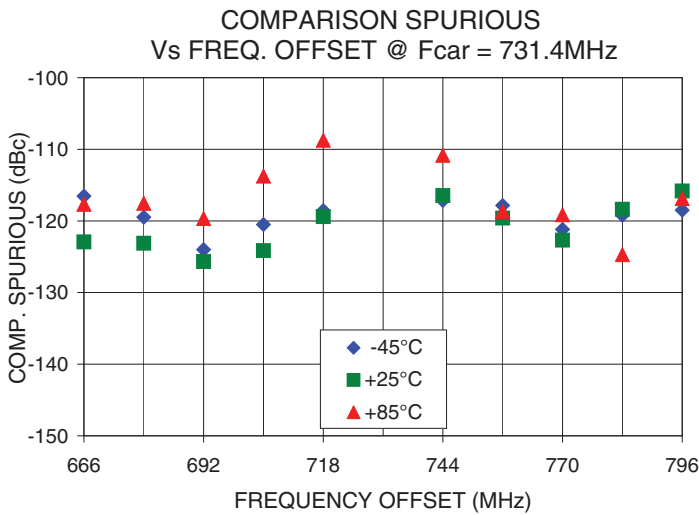
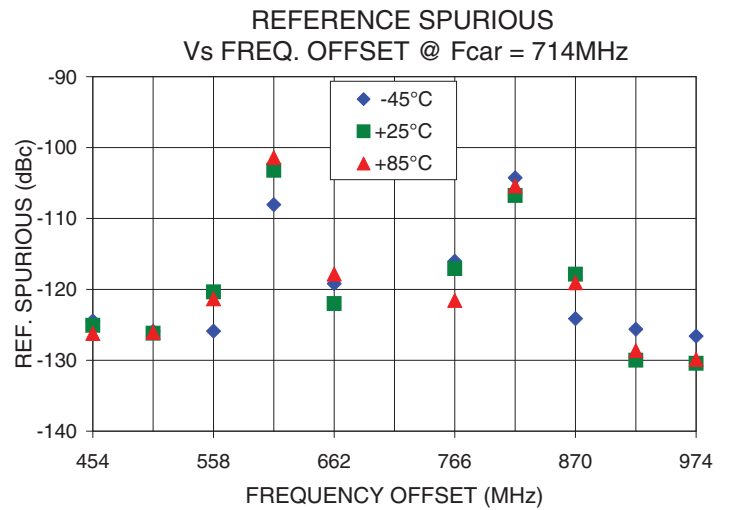
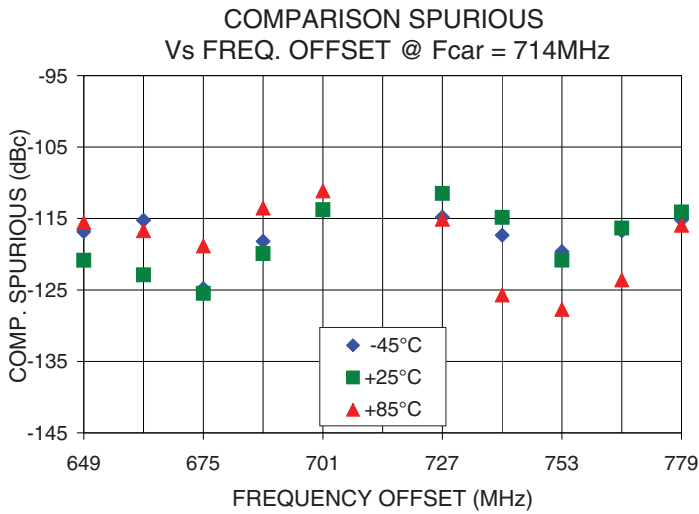

IF/RF MICROWAVE COMPONENTS • ISO 9001 ISO 14001 AS9100 CERTIFIED RoHS compliant  
P.O. Box 350166, Brooklyn, New York 11235-0003 (718) 934-4500 Fax (718) 332-4661



The Design Engineers Search Engine finds the model you need, Instantly • For detailed performance specs & shopping online see



Notes: 1. Performance and quality attributes and conditions not expressly stated in this specification sheet are intended to be excluded and do not form a part of this specification sheet. 2. Electrical specifications and performance data contained herein are based on Mini-Circuit's applicable established test performance criteria and measurement instructions. 3. The parts covered by this specification sheet are subject to Mini-Circuits standard limited warranty and terms and conditions (collectively, "Standard Terms"); Purchasers of this part are entitled to the rights and benefits contained therein. For a full statement of the Standard Terms and the exclusive rights and remedies thereunder, please visit Mini-Circuits' website at [www.minicircuits.com/MCLStore/terms.jsp](http://www.minicircuits.com/MCLStore/terms.jsp).

0.5 STEP SIZE & STEP SIZE SPURIOUS  
Vs FREQ. OFFSET @ F<sub>car</sub> = 714MHz

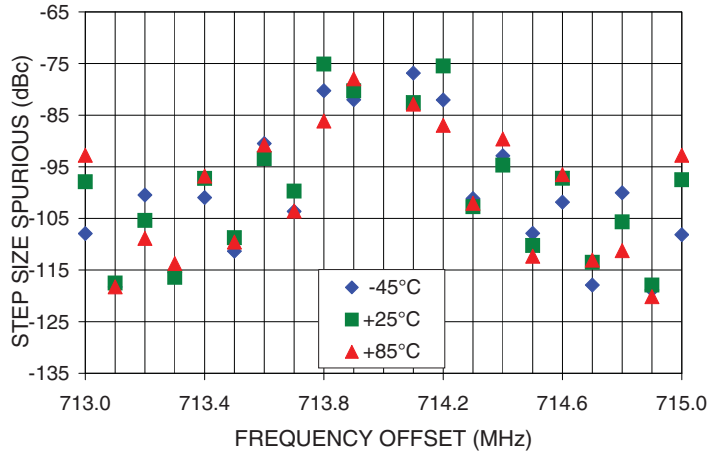

0.5 STEP SIZE & STEP SIZE SPURIOUS  
Vs FREQ. OFFSET @ F<sub>car</sub> = 731.4MHz

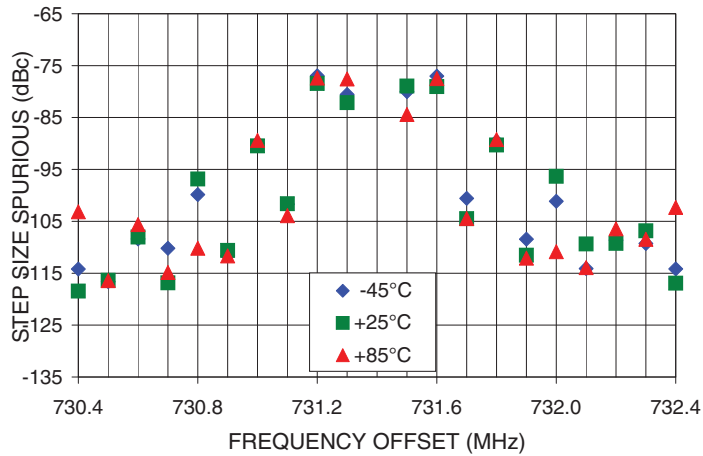

0.5 STEP SIZE & STEP SIZE SPURIOUS  
Vs FREQ. OFFSET @ F<sub>car</sub> = 749MHz

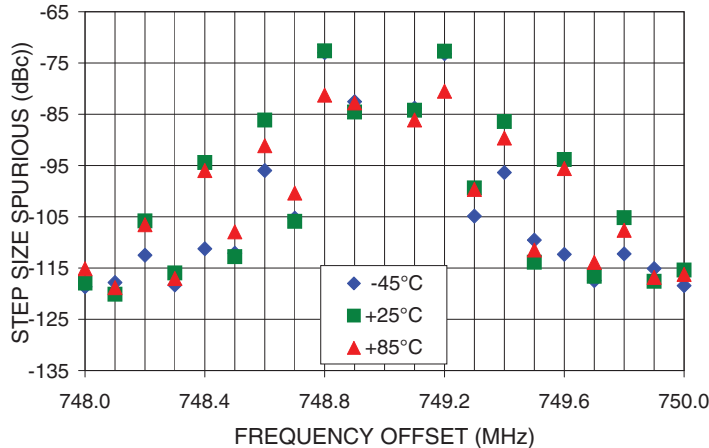

IF/RF MICROWAVE COMPONENTS • ISO 9001 ISO 14001 AS9100 CERTIFIED RoHS compliant  
P.O. Box 350166, Brooklyn, New York 11235-0003 (718) 934-4500 Fax (718) 332-4661



The Design Engineers Search Engine finds the model you need, Instantly • For detailed performance specs & shopping online see



Notes: 1. Performance and quality attributes and conditions not expressly stated in this specification sheet are intended to be excluded and do not form a part of this specification sheet. 2. Electrical specifications and performance data contained herein are based on Mini-Circuit's applicable established test performance criteria and measurement instructions. 3. The parts covered by this specification sheet are subject to Mini-Circuits standard limited warranty and terms and conditions (collectively, "Standard Terms"); Purchasers of this part are entitled to the rights and benefits contained therein. For a full statement of the Standard Terms and the exclusive rights and remedies thereunder, please visit Mini-Circuits' website at [www.minicircuits.com/MCLStore/terms.jsp](http://www.minicircuits.com/MCLStore/terms.jsp).

### Pin Configuration

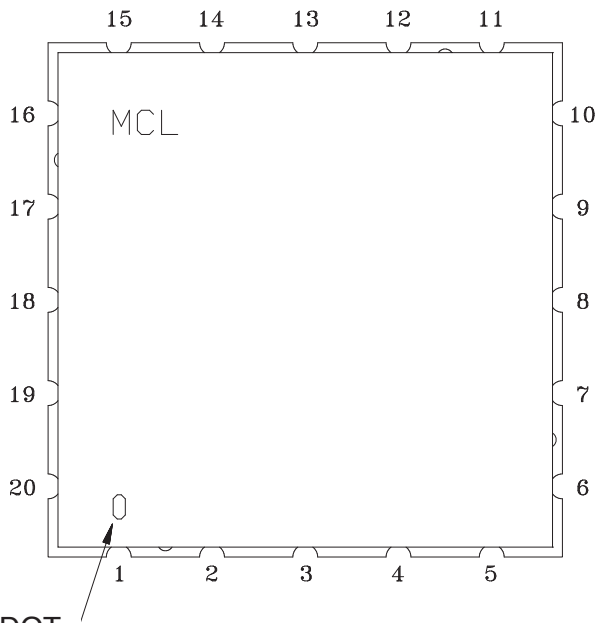

INDEX DOT

### Pin Connection

Pin Number	Function
1	GND
2	GND
3	GND
4	RF OUT
5	GND
6	GND
7	LOCK DET
8	LE
9	DATA
10	CLOCK
11	GND
12	REF IN
13	GND
14	GND
15	GND
16	VCC CP
17	VCC PLL
18	Not Connected
19	VCC VCO
20	GND

### Recommended Application Circuit

Note: REF IN and RF OUT ports are internally AC coupled.

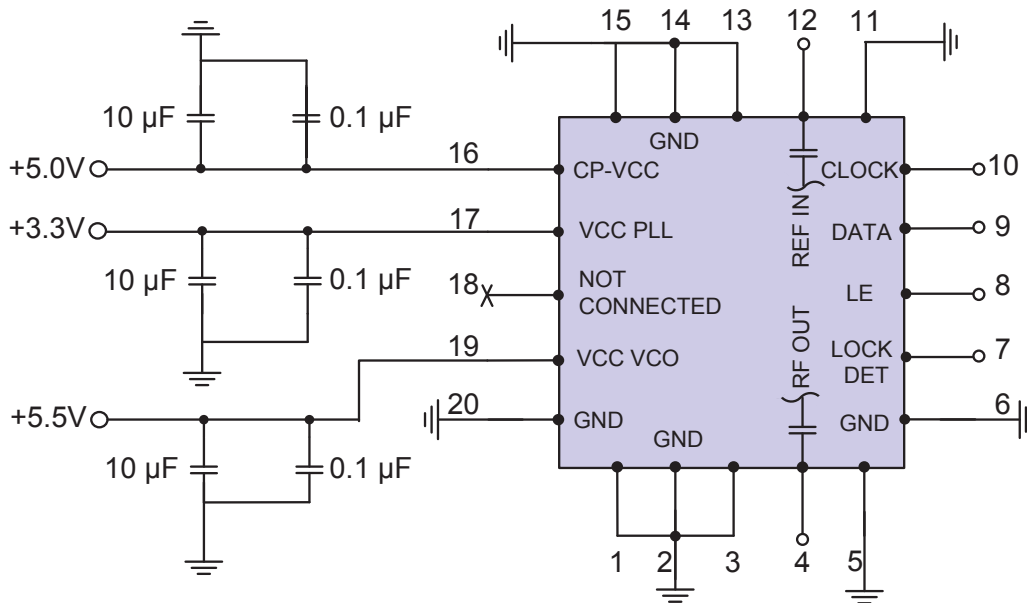

IF/RF MICROWAVE COMPONENTS • ISO 9001 ISO 14001 AS9100 CERTIFIED RoHS compliant  
 P.O. Box 350166, Brooklyn, New York 11235-0003 (718) 934-4500 Fax (718) 332-4661



The Design Engineers Search Engine finds the model you need, Instantly • For detailed performance specs & shopping online see



Notes: 1. Performance and quality attributes and conditions not expressly stated in this specification sheet are intended to be excluded and do not form a part of this specification sheet. 2. Electrical specifications and performance data contained herein are based on Mini-Circuit's applicable established test performance criteria and measurement instructions. 3. The parts covered by this specification sheet are subject to Mini-Circuits standard limited warranty and terms and conditions (collectively, "Standard Terms"); Purchasers of this part are entitled to the rights and benefits contained therein. For a full statement of the Standard Terms and the exclusive rights and remedies thereunder, please visit Mini-Circuits' website at [www.minicircuits.com/MCLStore/terms.jsp](http://www.minicircuits.com/MCLStore/terms.jsp).

### Device Marking

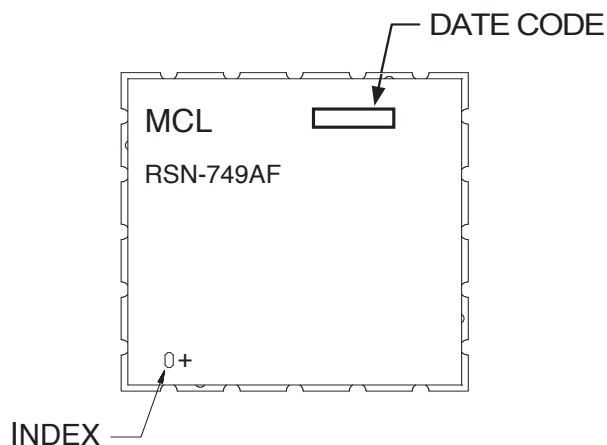

#### Additional Detailed Technical Information

Additional information is available on our web site. To access this information enter the model number on our web site home page.

**Case Style:** JG1228

**Tape & Reel:** TR-F99

**Suggested Layout for PCB Design:** PL-319

**Evaluation Board:** TB-554+

**Environment Ratings:** ENV03T2



IF/RF MICROWAVE COMPONENTS • ISO 9001 ISO 14001 AS9100 CERTIFIED RoHS compliant  
P.O. Box 350166, Brooklyn, New York 11235-0003 (718) 934-4500 Fax (718) 332-4661



The Design Engineers Search Engine finds the model you need, Instantly • For detailed performance specs & shopping online see



Notes: 1. Performance and quality attributes and conditions not expressly stated in this specification sheet are intended to be excluded and do not form a part of this specification sheet. 2. Electrical specifications and performance data contained herein are based on Mini-Circuit's applicable established test performance criteria and measurement instructions. 3. The parts covered by this specification sheet are subject to Mini-Circuits standard limited warranty and terms and conditions (collectively, "Standard Terms"); Purchasers of this part are entitled to the rights and benefits contained therein. For a full statement of the Standard Terms and the exclusive rights and remedies thereunder, please visit Mini-Circuits' website at [www.minicircuits.com/MCLStore/terms.jsp](http://www.minicircuits.com/MCLStore/terms.jsp).