

Voltage Variable Attenuator

VACC-22+

50Ω 1600 to 2200 MHz



Generic photo used for illustration purposes only

CASE STYLE: GF995

+RoHS Compliant

The +Suffix identifies RoHS Compliance. See our web site for RoHS Compliance methodologies and qualifications

Maximum Ratings

Operating Temperature	-45°C to 85°C
Storage Temperature	-55°C to 100°C
Absolute Max. Control Current	10mA
Absolute Max. RF Input Level	15dBm

Pin Connections

RF IN	2
V CONTROL 1	8
V CONTROL 2	4
RF OUT	6
GROUND	1,3,5,7

Equivalent schematic of DUT

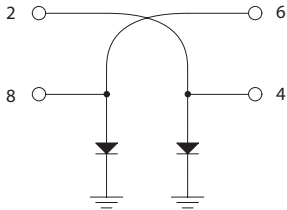

Outline Drawing

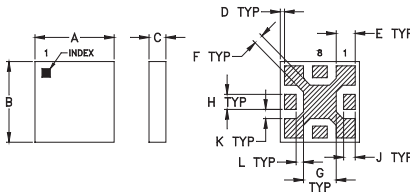

PCB Land Pattern

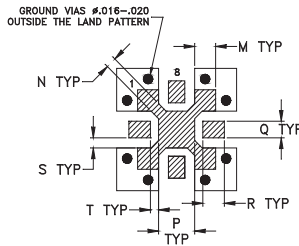

Suggested Layout,
Tolerance to be within ±.002

Outline Dimensions (inch/mm)

A	B	C	D	E	F	G	H	J
.150	.150	.050	.008	.036	.018	.062	.028	.022
3.81	3.81	1.27	0.20	0.91	0.46	1.57	0.71	0.56
K	L	M	N	P	Q	R	S	T
.017	.014	.036	.018	.062	.028	.037	.017	.014
0.43	0.36	0.91	0.46	1.57	0.71	0.94	0.43	0.36
								wt
								.014
								grams
								0.06

Features

- frequency range, 1600-2200 MHz
- IP3, 42 dBm typ.
- minimum current at min. attenuation
- low insertion loss
- aqueous washable
- protected by US Patent 7,030,713

Applications

- variable gain amplifier
- feed forward amps
- ALC circuits

Electrical Specifications

FREQ. (MHz)		INSERTION LOSS (dB) at 0V control voltage		ATTENUATION (dB)		IP3* (dBm)		RETURN LOSS (dB)		CONTROL VOLTAGE** (V)
Min.	Max.	Typ.	Max.	Typ.	Min.	Typ.	Min.	Typ.	Typ.	Typ.
1600	2220	1.2	1.5	25	23	42	38	20	20	0-5

* Input IP3 tested with two tones separated by 1 MHz at 7 dBm each and 0V control voltage.

** Using recommended control port biasing.

VACC-22+
ATTENUATION Vs. FREQUENCY Vs.
CONTROL VOLTAGE

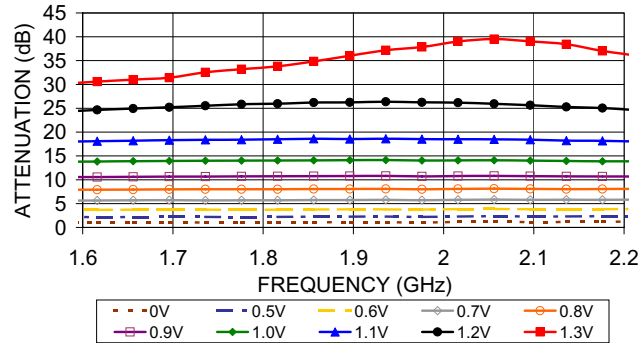

VACC-22+
TYPICAL ATTENUATION AT 1900 MHz

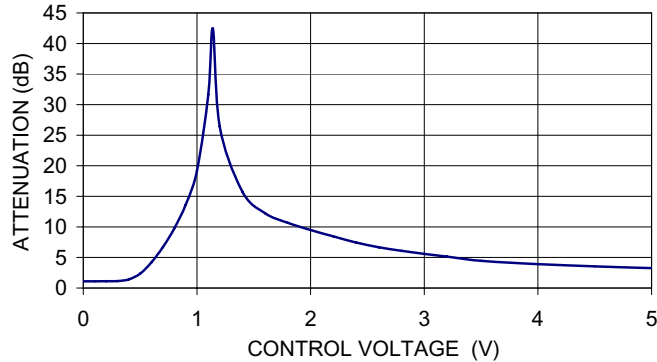

Notes

- Performance and quality attributes and conditions not expressly stated in this specification document are intended to be excluded and do not form a part of this specification document.
- Electrical specifications and performance data contained in this specification document are based on Mini-Circuit's applicable established test performance criteria and measurement instructions.
- The parts covered by this specification document are subject to Mini-Circuits standard limited warranty and terms and conditions (collectively, "Standard Terms"); Purchasers of this part are entitled to the rights and benefits contained therein. For a full statement of the Standard Terms and the exclusive rights and remedies thereunder, please visit Mini-Circuits' website at www.minicircuits.com/WCLStore/terms.jsp



Recommended control port biasing configuration

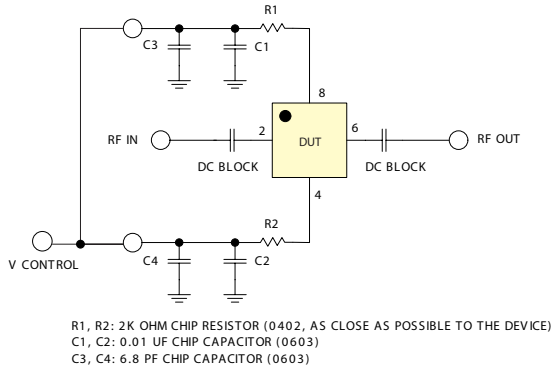

Demo Board MCL P/N: TB-250 Suggested PCB Layout (PL-148)

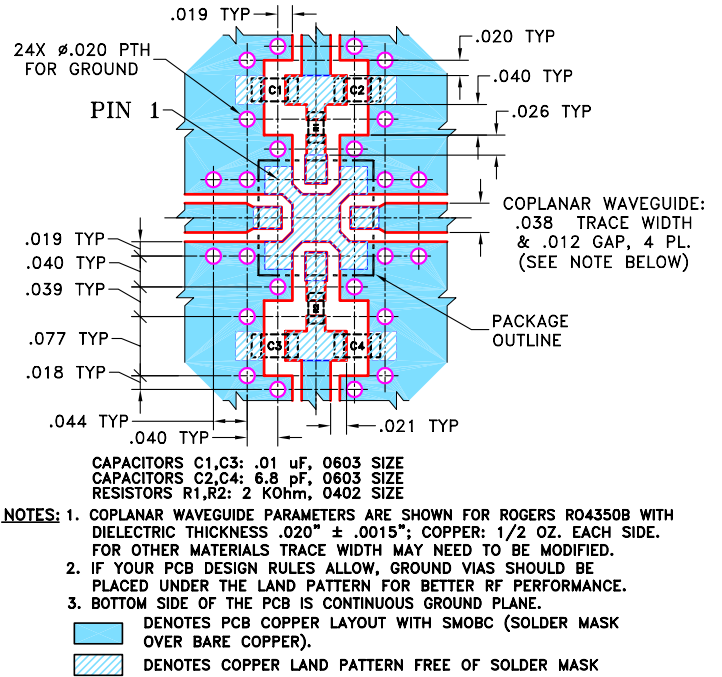

VACC-22+
INPUT RETURN LOSS vs. FREQUENCY vs. CONTROL VOLTAGE

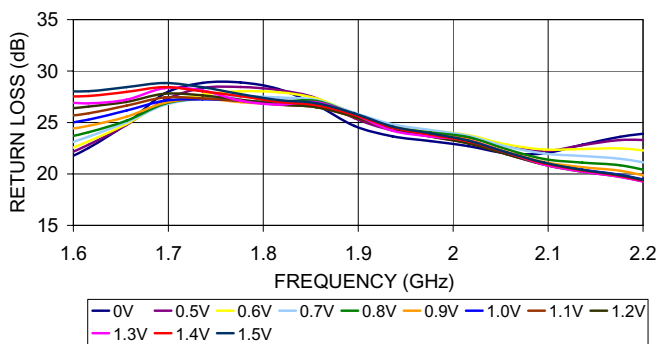

VACC-22+
OUTPUT RETURN LOSS vs. FREQUENCY vs. CONTROL VOLTAGE

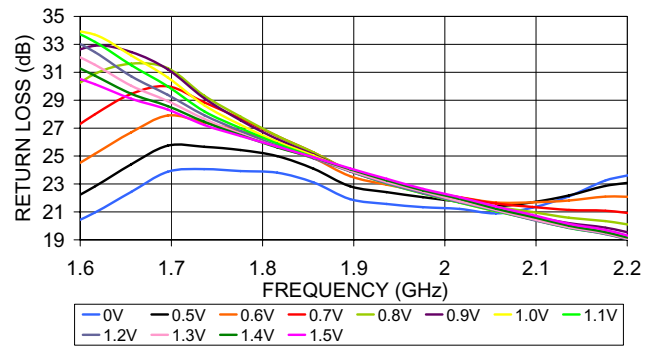

Notes

- A. Performance and quality attributes and conditions not expressly stated in this specification document are intended to be excluded and do not form a part of this specification document.
- B. Electrical specifications and performance data contained in this specification document are based on Mini-Circuit's applicable established test performance criteria and measurement instructions.
- C. The parts covered by this specification document are subject to Mini-Circuits standard limited warranty and terms and conditions (collectively, "Standard Terms"); Purchasers of this part are entitled to the rights and benefits contained therein. For a full statement of the Standard Terms and the exclusive rights and remedies thereunder, please visit Mini-Circuits' website at www.minicircuits.com/MCLStore/terms.jsp



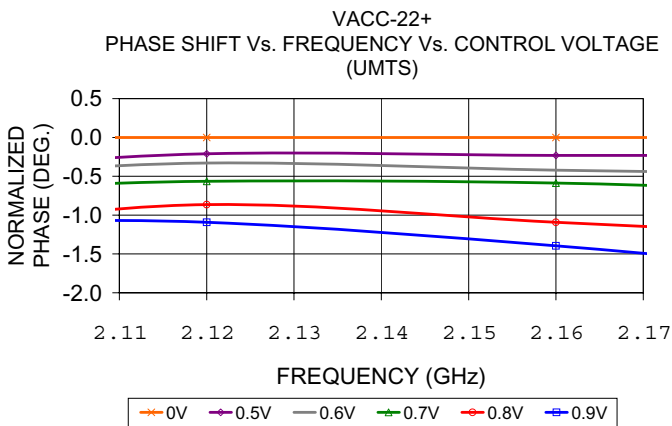
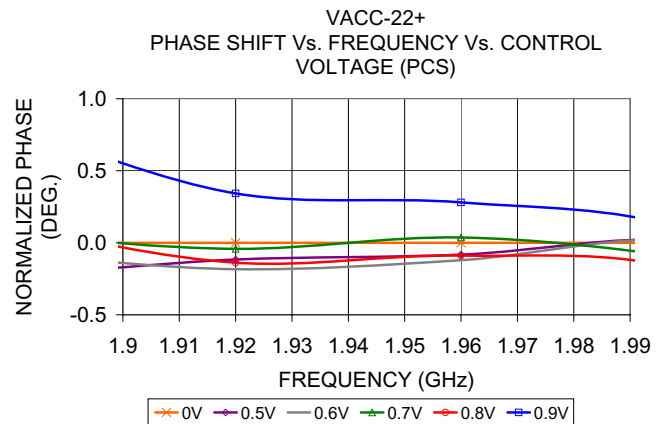
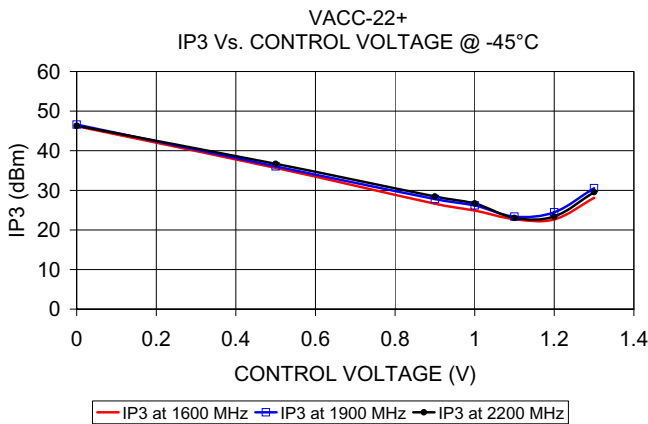
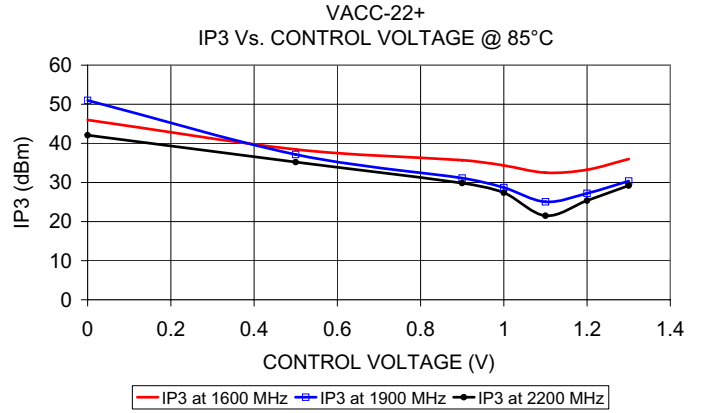
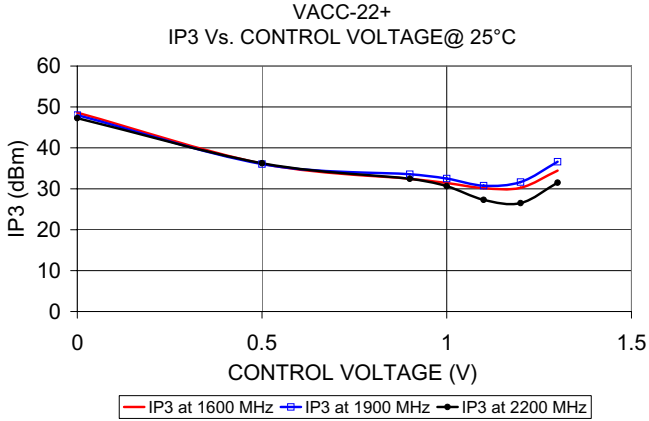

Notes

- A. Performance and quality attributes and conditions not expressly stated in this specification document are intended to be excluded and do not form a part of this specification document.
- B. Electrical specifications and performance data contained in this specification document are based on Mini-Circuit's applicable established test performance criteria and measurement instructions.
- C. The parts covered by this specification document are subject to Mini-Circuits standard limited warranty and terms and conditions (collectively, "Standard Terms"); Purchasers of this part are entitled to the rights and benefits contained therein. For a full statement of the Standard Terms and the exclusive rights and remedies thereunder, please visit Mini-Circuits' website at www.minicircuits.com/MCLStore/terms.jsp

