

### The Big Deal:

- Ultra Flat Gain Response:  
± 0.2 dB over 1700-2300 MHz
- 50Ω Input and Output:  
no External Components Required



CASE STYLE: DL1636

### Product Overview:

YSF-232+ is an advanced amplifier module in a Mini-Circuits System In Package **MSiP<sup>®</sup>**. This module is fully matched to 50Ω in/out impedance and has built-in Input & Output DC block capacitors. It is enclosed in a 5 x 6 mm MCLP plastic package. The YSF-232+ uses E-PHEMT technology enabling it to work with a single positive supply voltage.

### Key Features

Feature	Advantages
Superior Gain Flatness ± 0.2dB	The YSF-232+ provides industry leading gain flatness over the full PCS/UMTS communications band (1700-2300MHz) making this ideal for use in applications where gain-flatness and repeatability are critical performance requirements.
High Gain	The YSF-232+ is a two-stage design with internal feedback and bias to provide flat 20 dB nominal gain, supporting applications where a single gain block must overcome large system losses such as long cable runs and lossy components.
Strong Combination of Performance	The YSF-232+ provides a strong combination of performance parameters including high gain (20 dB), high IP3 (+35 dBm) and P1dB (+20 dBm) and low noise figures (2.9 dB) that are difficult to achieve in a single stage design and available only in the YSF amplifier series.
Integrated Matching, DC Blocking and Bias in Small Package	The YSF-232+ includes all support circuits including: Matching, Bias and DC Blocking, all integrated into a single 5x6mm package making the total footprint equal to or smaller than most solutions.
Excellent Return Loss	The YSF-232+ includes integrated input and output matching and bias circuits to make this amplifier a simple, complete drop-in solution. The matching circuits provide excellent output return loss (20dB), and are designed to give optimal P1dB and IP3 performance in a 50Ω environment.
High Reverse Isolation	With 30 dB of reverse isolation – the YSF-232+ is an ideal gain block for use in integrated systems to minimize VSWR interactions resulting from cascading highly reflective components such as sharp filters.

#### Notes

- A. Performance and quality attributes and conditions not expressly stated in this specification document are intended to be excluded and do not form a part of this specification document.  
 B. Electrical specifications and performance data contained in this specification document are based on Mini-Circuit's applicable established test performance criteria and measurement instructions.  
 C. The parts covered by this specification document are subject to Mini-Circuits standard limited warranty and terms and conditions (collectively, "Standard Terms"); Purchasers of this part are entitled to the rights and benefits contained therein. For a full statement of the Standard Terms and the exclusive rights and remedies thereunder, please visit Mini-Circuits' website at [www.minicircuits.com/MCLStore/terms.jsp](http://www.minicircuits.com/MCLStore/terms.jsp)



# Flat Gain Amplifier

1.7-2.3 GHz

## Product Features

- Matched 50-ohm surface mount amplifier
- High gain, 20 dB typ.
- Up to +20 dBm typ. output power
- High IP3, +35 dBm
- Low Noise Figure, 2.9 dB typ.
- High directivity, 30 dB isolation
- Internal Input & Output DC Block
- Separate terminal for DC
- Protected by us patent 8,994,157



## YSF-232+

CASE STYLE: DL1636

### +RoHS Compliant

The +Suffix identifies RoHS Compliance. See our web site for RoHS Compliance methodologies and qualifications

## Typical Applications

- Cellular
- WCDMA
- Portable Wireless
- Receivers & transmitters
- PCS-Korea

## General Description

YSF-232+ is an advanced amplifier module in a Mini-Circuits System In Package **MSiP<sup>®</sup>**. This module is fully matched to 50Ω in/out impedance and has built-in Input & Output DC block capacitors. It is enclosed in a 5 x 6 mm MCLP plastic package. The YSF-232+ uses E-PHEMT\* technology enabling it to work with a single positive supply voltage.

## simplified schematic and pad description

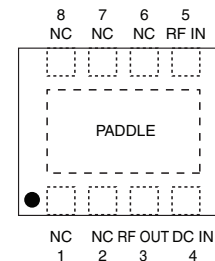
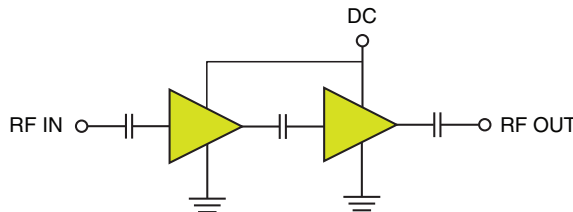

Function	Pad Number	Description
RF-IN	5	RF Input
RF-OUT	3	RF Output
DC	4	DC Supply
GND	Paddle	Connected to ground
NOT USED	1,2,6,7,8	No internal connection

\*Enhancement mode Pseudomorphic High Electron Mobility Transistor

### Notes

- A. Performance and quality attributes and conditions not expressly stated in this specification document are intended to be excluded and do not form a part of this specification document.  
 B. Electrical specifications and performance data contained in this specification document are based on Mini-Circuit's applicable established test performance criteria and measurement instructions.  
 C. The parts covered by this specification document are subject to Mini-Circuits standard limited warranty and terms and conditions (collectively, "Standard Terms"); Purchasers of this part are entitled to the rights and benefits contained therein. For a full statement of the Standard Terms and the exclusive rights and remedies thereunder, please visit Mini-Circuits' website at [www.minicircuits.com/MCLStore/terms.jsp](http://www.minicircuits.com/MCLStore/terms.jsp)



**Electrical Specifications<sup>(1)</sup> at 25°C, Zo=50Ω unless noted**

Parameter	Condition (MHz)	Min.	Typ.	Max.	Units
Frequency Range		1700		2300	MHz
Gain	1700	17.8	19.8	22.0	dB
	2000	18.0	20.0	22.0	
	2300	17.6	19.5	21.5	
Gain Flatness			± 0.2		dB
Input Return Loss	1700	—	10.0		dB
	2000	8.0	10.8		
	2300	—	12.6		
Output Return Loss	1700	—	23.5		dB
	2000	18.0	23.0		
	2300	—	19.0		
Reverse Isolation			30.0		dB
Output Power @ 1 dB compression	1700	—	20.0		dBm
	2000	—	20.0		
	2300	18.0	20.0		
Output Power @ 3 dB compression			21.0		dBm
Output IP3	1700	—	35.0		dBm
	2000	31.0	35.0		
	2300	—	35.0		
Noise Figure	1700		3.0	—	dB
	2000		2.8	3.8	
	2300		2.5	—	
Device Operating Voltage			5		V
Device Operating Current			118	145	mA
Device Current Variation vs. Temperature <sup>(2)</sup>			2		μA/°C
Device Current Variation vs Voltage			0.002		mA/mV
Thermal Resistance, junction-to-ground lead <sup>(3)</sup>			56		°C/W

<sup>(1)</sup> Measured on Mini-Circuits Characterization test board TB-616+. See Characterization Test Circuit (Fig. 1)

<sup>(2)</sup> D(+85°C to -45°C)

<sup>(3)</sup> Thermal Resistance=  $\frac{\text{Hot spot temperature} - \text{Ground lead temperature}}{\text{Power Dissipation}}$

**Absolute Maximum Ratings**

Parameter	Ratings	Units
Operating Temperature <sup>(4)</sup>	-40 to 85	°C
Storage Temperature	-65 to 150	°C
DC Voltage on Pad 4	7	V
Power Dissipation	1.5	W
Input Power	21	dBm

Note: Permanent damage may occur if any of these limits are exceeded.

These ratings are not intended for continuous normal operation.

<sup>(4)</sup> Case is defined as ground paddle.

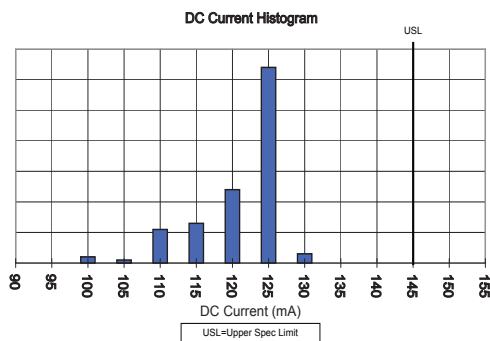

**Notes**

- A. Performance and quality attributes and conditions not expressly stated in this specification document are intended to be excluded and do not form a part of this specification document.
- B. Electrical specifications and performance data contained in this specification document are based on Mini-Circuit's applicable established test performance criteria and measurement instructions.
- C. The parts covered by this specification document are subject to Mini-Circuits standard limited warranty and terms and conditions (collectively, "Standard Terms"); Purchasers of this part are entitled to the rights and benefits contained therein. For a full statement of the Standard Terms and the exclusive rights and remedies thereunder, please visit Mini-Circuits' website at [www.minicircuits.com/MCLStore/terms.jsp](http://www.minicircuits.com/MCLStore/terms.jsp)



### Characterization Test Circuit

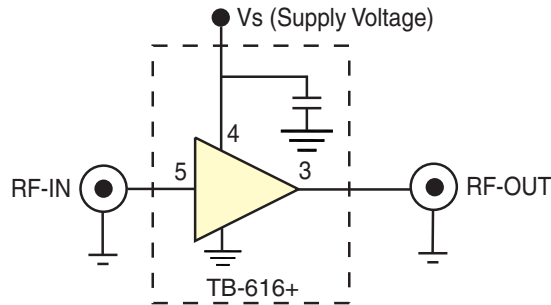

**Fig 1.** Block Diagram of Test Circuit used for characterization. (DUT soldered on Mini-Circuits Characterization Test Fixture TB-616+) Gain, Return loss, Output power at 1dB compression (P1 dB), Output IP3 (OIP3) and Noise Figure measured using Agilent's N5242A PNA-X microwave network analyzer.

**Conditions:**

1. Gain: Pin= -25dBm
2. Output IP3 (OIP3): Two tones, spaced 10 MHz apart, 2.5 dBm/tone at output.

### Recommended Application Circuit

(refer to evaluation board for PCB Layout and component values)

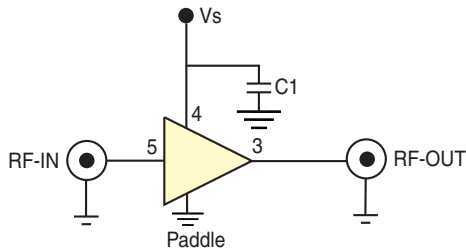

**Fig 2.** Recommended Application Circuit

### Product Marking

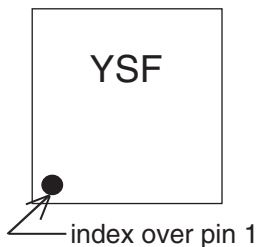

**Notes**

- A. Performance and quality attributes and conditions not expressly stated in this specification document are intended to be excluded and do not form a part of this specification document.
- B. Electrical specifications and performance data contained in this specification document are based on Mini-Circuit's applicable established test performance criteria and measurement instructions.
- C. The parts covered by this specification document are subject to Mini-Circuits standard limited warranty and terms and conditions (collectively, "Standard Terms"); Purchasers of this part are entitled to the rights and benefits contained therein. For a full statement of the Standard Terms and the exclusive rights and remedies thereunder, please visit Mini-Circuits' website at [www.minicircuits.com/MCLStore/terms.jsp](http://www.minicircuits.com/MCLStore/terms.jsp)

<b>Additional Detailed Technical Information</b>	
<i>additional information is available on our dash board. To access this information <a href="#">click here</a></i>	
<b>Performance Data</b>	Data Table
	Swept Graphs
	S-Parameter (S2P Files) Data Set (.zip file)
<b>Case Style</b>	DL1636 Plastic package, exposed paddle, lead finish: tin/silver/nickel
<b>Tape &amp; Reel</b> Standard quantities available on reel	F68 7" reels with 20, 50, 100, 200, 500 or 1K devices. 13" reels with 2K, or 4K devices.
<b>Suggested Layout for PCB Design</b>	PL-352
<b>Evaluation Board</b>	TB-616-4+
<b>Environmental Ratings</b>	ENV08T1

### ESD Rating

Human Body Model (HBM): Class 1A in accordance with ANSI/ESD STM 5.1 - 2001

Machine Model (MM): Class M3 (25V) in accordance with ANSI/ESD STM5.2-1999



**Attention**  
Observe precautions  
for handling electrostatic  
sensitive devices

### MSL Rating

Moisture Sensitivity: MSL1 in accordance with IPC/JEDEC J-STD-020D

### MSL Test Flow Chart

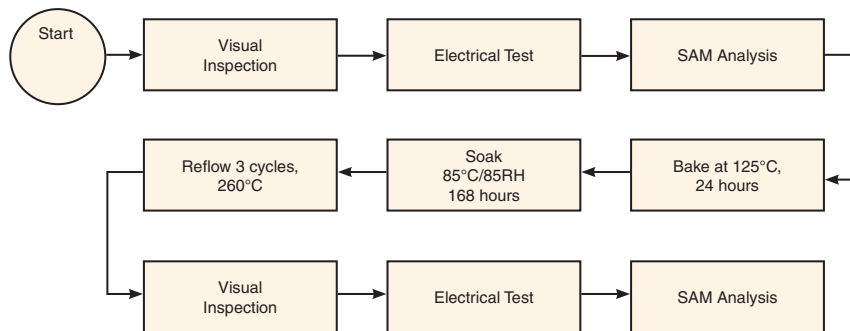

**Notes**

- A. Performance and quality attributes and conditions not expressly stated in this specification document are intended to be excluded and do not form a part of this specification document.
- B. Electrical specifications and performance data contained in this specification document are based on Mini-Circuit's applicable established test performance criteria and measurement instructions.
- C. The parts covered by this specification document are subject to Mini-Circuits standard limited warranty and terms and conditions (collectively, "Standard Terms"); Purchasers of this part are entitled to the rights and benefits contained therein. For a full statement of the Standard Terms and the exclusive rights and remedies thereunder, please visit Mini-Circuits' website at [www.minicircuits.com/MCLStore/terms.jsp](http://www.minicircuits.com/MCLStore/terms.jsp)

