



TTL

Mechanical Switch

ZK-MSP2TA-18

Mini-Circuits

50 Ω DC to 18 GHz SPDT SMA-Female

THE BIG DEAL

- Mechanical SPDT absorptive switch
- TTL interface for simple control integration
- Fail-safe/redundancy switching
- LED switch state indicator
- High isolation
- Low insertion loss

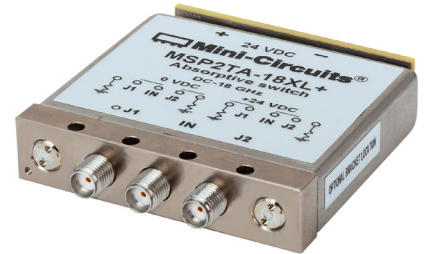

Generic photo used for illustration purposes only

APPLICATIONS

- RF signal routing/switch matrices
- Automated test & measurement systems
- 5G FR1, WiFi 6E, UWB, Bluetooth
- Military radio, radar & electronic warfare
- Harmonic testing

FUNCTIONAL BLOCK DIAGRAM

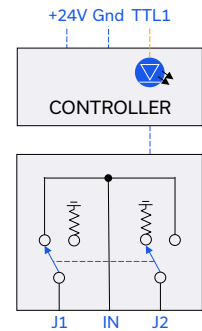

PRODUCT OVERVIEW

Mini-Circuits' ZK-MSP2TA-18 is an ultra-reliable electro-mechanical SPDT switch operating over a wide bandwidth from DC to 18 GHz with high isolation and low insertion loss. The switch is absorptive and fail-safe with a break before make configuration and lifetime of 5 million switching cycles when used within the noted specifications. All RF connections (SMA female) are conveniently grouped together on the front of the switch.

Simple control via TTL voltage levels allows integration with a wide range of microcontroller, embedded or custom systems without the additional complexity of USB or Ethernet control from a PC. The TTL control input and +24V DC supply connections are accessed through a single 3-pin PCB header connector on the rear of the switch. An LED indicator is also included on the rear of the package to give a convenient visual read out of the current switch state. An LED light-pipe connector allows the indicator to be routed to wherever it is needed when the switch is integrated into a final product.

KEY FEATURES

Feature	Advantages
Mechanical switch	Mechanical absorptive switches provide low loss, high isolation, high reliability, repeatable performance and internal termination of input signals on the disconnected paths
High repeatability	The high repeatability of switching cycles ensures reliable performance, critical for automated testing and other measurement applications.
Fail-safe design	The switch reverts to a known default state when the DC supply is removed, allowing their use in systems that must continue to operate safely in the event of power failure
Break-before-make configuration	Prevents a momentary connection of the old and new signal paths, reducing the inconsistent transient effects that could otherwise be observed during switching
TTL control	Simple control via TTL logic levels allows integration with a wide range of microcontroller, embedded, or custom systems.

REV. A
ECO-021312
ZK-MSP2TA-18
MCL NY
240326





TTL

Mechanical Switch

ZK-MSP2TA-18

Mini-Circuits

50 Ω DC to 18 GHz SPDT SMA-Female

ELECTRICAL SPECIFICATIONS AT +25°C

Parameter	Conditions	Min.	Typ.	Max.	Units
Frequency Range		DC		18	GHz
Insertion Loss	DC - 8 GHz		0.15	0.30	dB
	8 - 12 GHz		0.25	0.40	
	12 - 18 GHz		0.30	0.50	
Isolation (Inactive Paths) ¹	DC - 8 GHz	75	90		dB
	8 - 12 GHz	70	80		
	12 - 18 GHz	60	66		
Return Loss ²	DC - 8 GHz		20		dB
	8 - 12 GHz		20		
	12 - 18 GHz		19		
Switching Time			25		ms
RF Input Power (Cold Switching)	DC-18 GHz			20	W
	Into internal termination			1	
Switch Lifetime	100 mW hot switching ³		5		million cycles
	1W hot switching		1		

1. Isolation measured between Com and the disconnected port. Example: Isolation for Com to 1 is the leakage measured at port 1 from a signal input when the active switch path is set to Com to 2.

2. Return loss into all ports in all states.

3. Hot switching power above this level will degrade the switch's lifetime.



TTL

Mechanical Switch

ZK-MSP2TA-18

Mini-Circuits

50 Ω DC to 18 GHz SPDT SMA-Female

TYPICAL PERFORMANCE CURVES

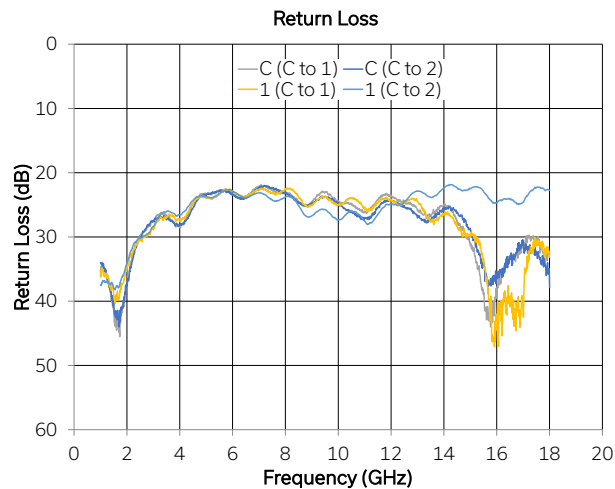
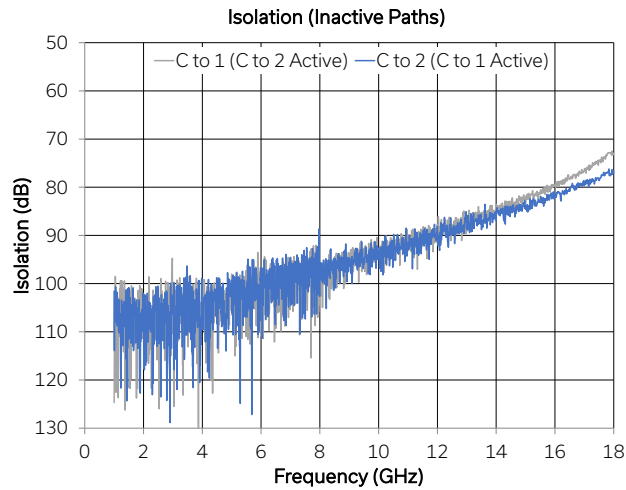
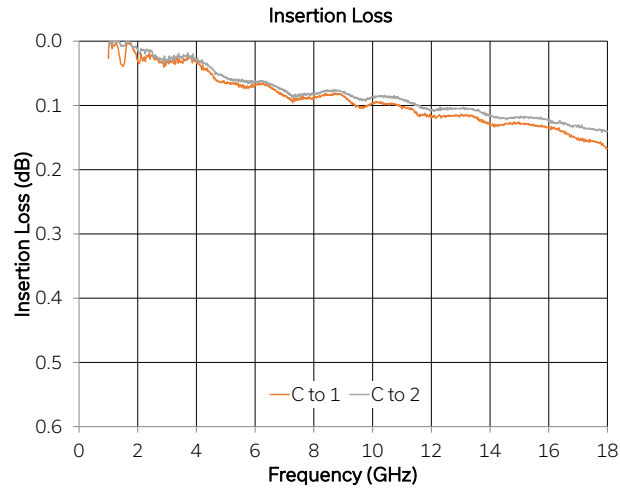



TTL

Mechanical Switch

ZK-MSP2TA-18

Mini-Circuits

50 Ω DC to 18 GHz SPDT SMA-Female

ABSOLUTE MAXIMUM RATINGS⁴

Parameter	Conditions	Limits	Units
Temperature	Operating	0 to +50	°C
	Storage	-20 to +60	
DC Voltage	Supply Voltage	+26	V
	Control Voltage	+5.5	
RF Input Power (No Damage)	Cold switching	20	W
	Hot switching	1	
	Into internal termination	1	

4. Permanent damage may occur if any of these limits are exceeded. Operating in the range between operating power limits and absolute maximum ratings for extended periods may result in reduced life and reliability.

DC ELECTRICAL SPECIFICATIONS

Parameter	Conditions	Typ	Units
Supply Voltage		24	V
Current Consumption	All ports disconnected	20	mA
	Any port active	220	

FUNCTIONAL BLOCK DIAGRAM

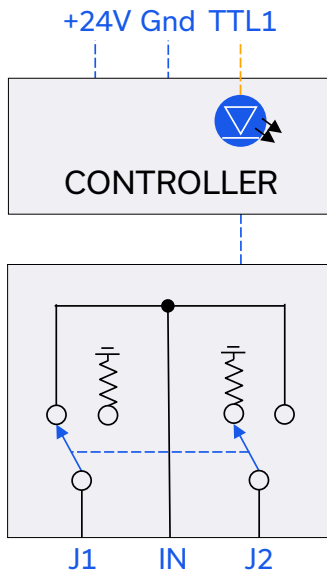

CONNECTIONS

Port	Connector
IN, J1-J2 ⁵	SMA female
DC & Control	Molex 53398-0371 (3-pin) ⁶
LED	Bivar SMFLP series ⁷

5. IN = RF common port; J1-J2 = RF input / output ports

6. Mating connector is Molex 51021-0300

7. Compatible with Bivar SMFLP light pipe system (1mm diameter optical fiber)



CONTROL

ZK-MSP2TA-18 requires a single +24V DC voltage supply and ground connection, with 1 control input using TTL logic levels.

Connect the included control cable assembly to the 3-pin header on the rear of ZK-MSP2TA-18. The other end of the cable assembly has exposed "pig-tail" wires which should be connected to the +24V DC supply and a 1-bit TTL control source.

The default switch state is in to J1, with J2 internally terminated. The switch is always in this state when the control input is at logic 0, or when no +24V DC supply is present.

Please contact testsolutions@minicircuits.com for support

SWITCH STATE TABLE

TTL Input	Switch State	LED Color
Low	In to J1	Green
High	In to J2	Orange

CONTROL HARNESS (B66-0001-12)

3-Pin Connector Pin	Bare Wire Color	Function
1	Red	TTL
2	Brown	Ground
3	White	+24 V DC Supply

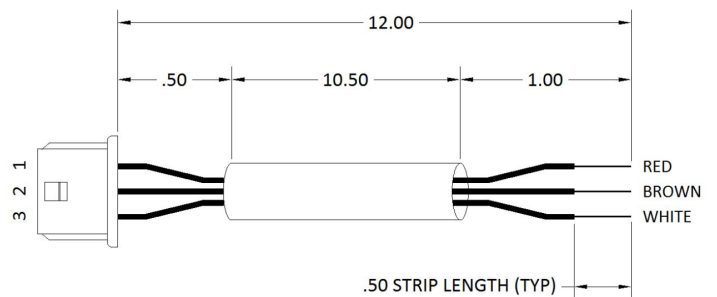



TTL

Mechanical Switch

ZK-MSP2TA-18

Mini-Circuits

50 Ω DC to 18 GHz SPDT SMA-Female

CASE STYLE DRAWING

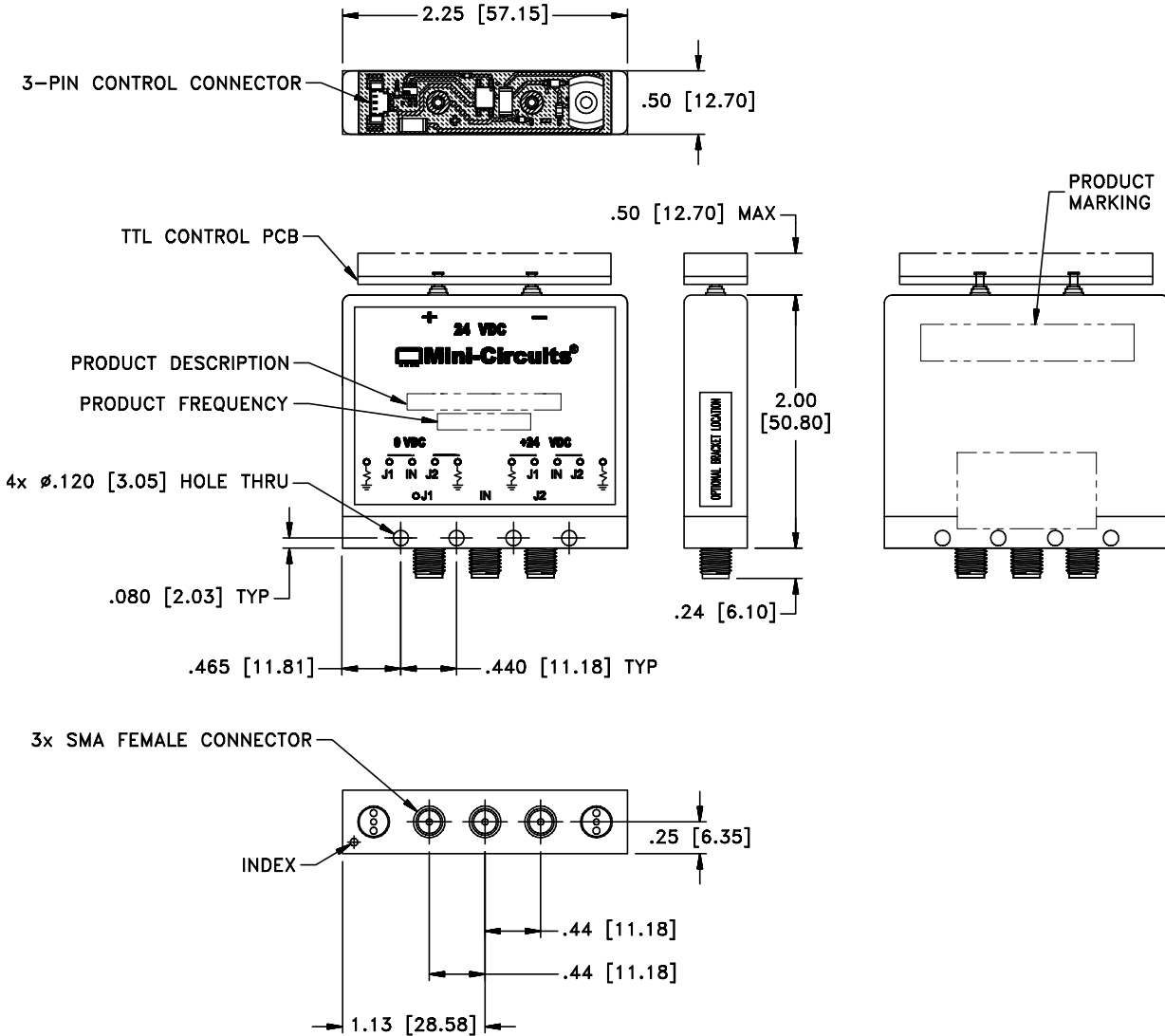

Weight: 95 grams.

Dimensions are in inches [mm]. Tolerances: 2 Pl. ±.03; 3 Pl. ±.015.

PRODUCT MARKING*

Product Marking: ZK-MSP2TA-18

Product Description: MSP2TA-18XL+ Absorptive switch

Product Frequency: DC - 18 GHz

*Marking may contain other features or characters for internal lot control





TTL

Mechanical Switch

ZK-MSP2TA-18

Mini-Circuits

50 Ω DC to 18 GHz SPDT SMA-Female

DETAILED MODEL INFORMATION IS AVAILABLE ON OUR WEBSITE [CLICK HERE](#)

Case Style	FP2963
Environmental Rating	ENV55
Regulatory Compliance	RoHS Compliant

Contact Us: testsolutions@minicircuits.com

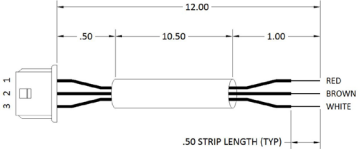
Included Accessories	Part Number	Description
	B66-0002-18	Control cable assembly (12" length) – 3-pin header connector (Molex 51021-0300) to 3 x bare wires (each 28 AWG)

- NOTES**
- A. Performance and quality attributes and conditions not expressly stated in this specification document are intended to be excluded and do not form a part of this specification document.
 - B. Electrical specifications and performance data contained in this specification document are based on Mini-Circuit's applicable established test performance criteria and measurement instructions.
 - C. The parts covered by this specification document are subject to Mini-Circuits standard limited warranty and terms and conditions (collectively, "Standard Terms"); Purchasers of this part are entitled to the rights and benefits contained therein. For a full statement of the standard. Terms and the exclusive rights and remedies thereunder, please visit Mini-Circuits' website at www.minicircuits.com/MCLStore/terms.jsp

