



Coaxial Cable

086 SBSM Model Series

50Ω DC to 18 GHz



CASE STYLE: KP1567-XX

XX= cable length in inches

The Big Deal

- Hand formable with tight bend radius
- SMA-F bulkhead connector at one end
- Excellent Return Loss and Insertion Loss
- Ideal for interconnect of assembled systems

Product Overview

The 086 SBSM Series Hand-Flex Coaxial Cables are ideal for interconnection of coaxial components or sub-systems to equipment racks. The construction includes a silver-plated copper-clad steel center conductor which maintains the shape after bending. The outer shield is copper braid, tin soaked, which minimizes signal leakage and at the same time flexible for easy bend. Dielectric is low loss PTFE. Connectors have passivated stainless-steel coupling nut over a gold plated connector body. SMA-M connector has gold plated, brass center conductor and SMA-F has gold plated BeCuB center conductor.

Key Features

Feature	Advantages
Hand-Formable RF Cables	The 086 Series Hand-Flex cables are hand formable making them ideal for use integrating coaxial components and sub-assemblies without the need for special cable-bending tools and alleviating the risk of damage during the bending process typical of semi-rigid coaxial cable assemblies.
SMA-F bulkhead connector at one end	Mounts directly on equipment racks eliminating need for bulkhead adapter, thereby improving reliability.
Tight Bend Radius	Capable of only 6mm bend radius, the 086 Hand Flex series is able to make connections in tight spaces making these cables ideal for dense system integration.
Excellent Return loss	Supporting typical return loss of 26 dB to 6 GHz and 19 dB to 18 GHz, the 086 Series Hand-Flex Cables are ideally suited for interconnecting a wide variety of RF components while minimizing VSWR ripple contribution due to mating cables & connectors.
Good Power Handling Capability: • 211W at 0.5 GHz • 35W at 18 GHz	Mini-Circuits 086 Cable series can support medium to high RF power levels enabling these cables to be used in the transmit path. (power rating is at sea-level altitudes)
Built in Anti-torque nut	Mini-Circuits 086 Series Hand Flex cables include an anti-torque feature to support the straight SMA connector body during installation alleviating risk of stress to the connector/cable interface.

Notes

- A. Performance and quality attributes and conditions not expressly stated in this specification document are intended to be excluded and do not form a part of this specification document.
 B. Electrical specifications and performance data contained in this specification document are based on Mini-Circuit's applicable established test performance criteria and measurement instructions.
 C. The parts covered by this specification document are subject to Mini-Circuits standard limited warranty and terms and conditions (collectively, "Standard Terms"); Purchasers of this part are entitled to the rights and benefits contained therein. For a full statement of the Standard Terms and the exclusive rights and remedies thereunder, please visit Mini-Circuits' website at www.minicircuits.com/MCLStore/terms.jsp



HAND FLEX™ Coaxial Cable

50Ω 10 inch DC to 18 GHz

086-10SBSM+

Maximum Ratings

Operating Temperature	-55°C to 105°C		
Storage Temperature	-55°C to 105°C		
Power Handling at 25°C, Sea Level	211W at	0.5 GHz	
	150W at	1 GHz	
	101W at	2 GHz	
	59W at	6 GHz	
	45W at	10 GHz	
	35W at	18 GHz	

Permanent damage may occur if any of these limits are exceeded.

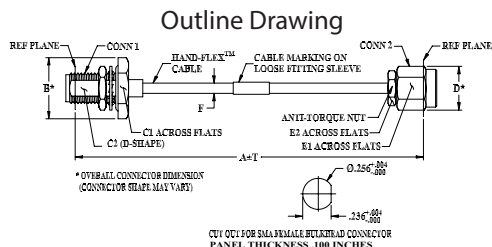

Outline Dimensions (in/mm)

A	B	C1	C2	D
10.0	.51	.438	.232	.36
254.00	12.95	11.13	5.89	9.14
E1	E2	F	T	wt
.313	.250	.108	0.1	grams
7.95	6.35	2.75	2.54	10.57

Cable Construction

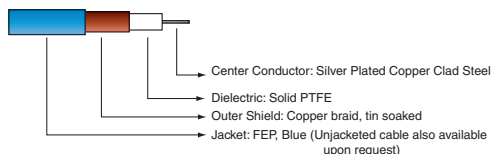

Connectors: Coupling Nut: Stainless Steel Passivated
 Body: Stainless Steel Gold Plated
 Center Pin: Brass, Gold Plated (SMA-M) and BeCuB Gold Plated (SMA-F)

Features

- Wideband frequency coverage, DC to 18 GHz
- Low Loss, 1.0 dB at 18 GHz
- Excellent Return Loss, 25 dB at 18 GHz
- SMA-F bulkhead connector at one end
- Hand formable to almost any custom shape without special bending tools
- 6mm bend radius for tight installations
- Anti-torque nut prevents cable stress during installation
- Insulated outer jacket standard
- Connector interface, meets MIL-STD-348
- Ideal for interconnect of assembled systems

Applications

- Bulkhead connector mounts on front panel of equipment racks
- Replacement for custom bent 0.086" semi-rigid cables
- Communication receivers and transmitters
- Military and aerospace system
- Environmental and test chambers

Electrical Specifications at 25°C

Parameter	Condition (GHz)	Min.	Typ.	Max.	Unit
Frequency Range		DC		18	GHz
Length ¹			10		inches
Insertion Loss	DC - 2	—	0.2	0.41	
	2 - 6	—	0.36	0.74	dB
	6 - 10	—	0.58	1.0	
Return Loss	10 - 18	—	0.78	1.36	
	DC - 2	23	37	—	
	2 - 6	23	31	—	dB
	6 - 10	17	30	—	
	10 - 18	16	27	—	

1. Custom sizes available, consult factory.

Typical Performance Data

Frequency (MHz)	Insertion Loss (dB)	Return Loss (dB)	
		SMA-Male	SMA-Female Bulkhead
100	0.05	40.3	40.4
1008	0.20	36.9	37.8
1800	0.27	35.9	36.1
2000	0.30	31.9	34.3
4001	0.43	27.5	28.8
5000	0.49	25.4	25.9
6000	0.54	28.8	28.7
7001	0.57	37.2	33.3
8001	0.62	29.9	28.6
9000	0.67	25.3	24.1
10000	0.70	25.2	24.7
12001	0.76	29.4	36.2
14001	0.86	24.4	35.3
16000	0.91	27.3	26.2
18000	1.02	25.2	24.6

086-10SBSM+ INSERTION LOSS

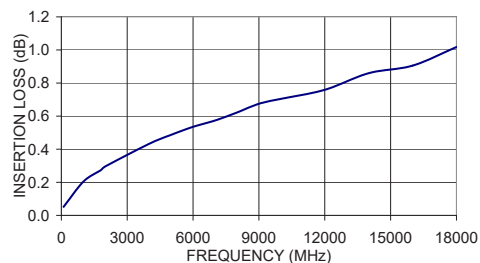

086-10SBSM+ RETURN LOSS

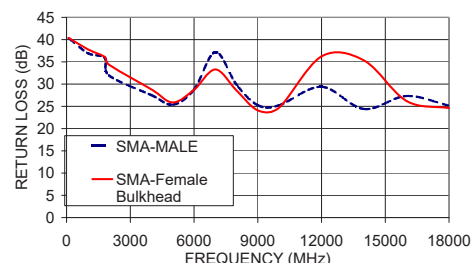

Notes

- Performance and quality attributes and conditions not expressly stated in this specification document are intended to be excluded and do not form a part of this specification document.
- Electrical specifications and performance data contained in this specification document are based on Mini-Circuit's applicable established test performance criteria and measurement instructions.
- The parts covered by this specification document are subject to Mini-Circuits standard limited warranty and terms and conditions (collectively, "Standard Terms"); Purchasers of this part are entitled to the rights and benefits contained therein. For a full statement of the Standard Terms and the exclusive rights and remedies thereunder, please visit Mini-Circuits' website at www.minicircuits.com/WCLStore/terms.jsp



www.minicircuits.com P.O. Box 350166, Brooklyn, NY 11235-0003 (718) 934-4500 sales@minicircuits.com

Rev. B
 ECO-009593
 086-10SBSM+
 RS/CP/AM
 210907



Generic photo used for illustration purposes only

CASE STYLE: KP1567-10

Connectors	Model
Conn1 SMA-Male	Conn2 SMA-Female Bulkhead
	086-10SBSM+

+RoHS Compliant

The +Suffix identifies RoHS Compliance. See our web site for RoHS Compliance methodologies and qualifications

Proper Cable Connection Using Anti-Torque Nut

Mini-Circuits 086-series HandFlex™ interconnect cables are constructed with an anti-torque nut adjacent to the connector coupling nut. When used properly, this feature prevents possible damage to the cable due to torquing and twisting when tightening the cable connector.

To properly tighten the cable connector:

- 1) The cable connector includes a coupling nut which rotates to fasten the connector, and an anti-torque nut, which is fixed to prevent the cable from twisting during connection.

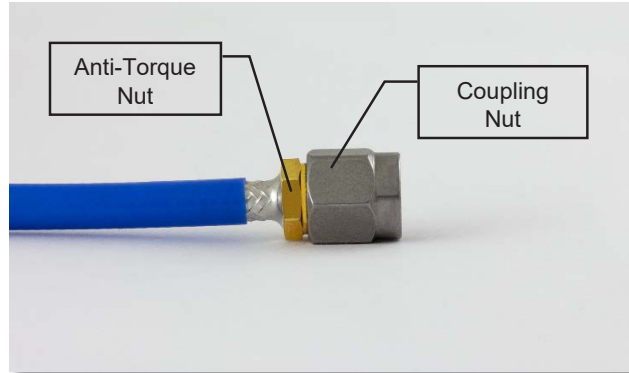

- 2) To properly tighten the cable, use a standard 1/4-inch open end wrench to brace the anti-torque nut.
- 3) Using a 5/16-inch open end wrench, rotate the coupling nut clockwise to tighten the cable connector.

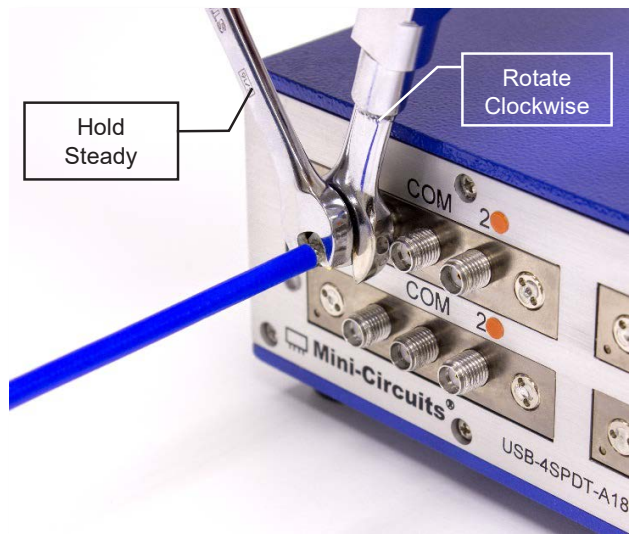

***NOTE:** Mini-Circuits recommends using a 5/16-inch open end wrench calibrated to 8 inch-pounds maximum torque to prevent damage due to over-torquing the connector.

Notes

- A. Performance and quality attributes and conditions not expressly stated in this specification document are intended to be excluded and do not form a part of this specification document.
- B. Electrical specifications and performance data contained in this specification document are based on Mini-Circuit's applicable established test performance criteria and measurement instructions.
- C. The parts covered by this specification document are subject to Mini-Circuits standard limited warranty and terms and conditions (collectively, "Standard Terms"); Purchasers of this part are entitled to the rights and benefits contained therein. For a full statement of the Standard Terms and the exclusive rights and remedies thereunder, please visit Mini-Circuits' website at www.minicircuits.com/MCLStore/terms.jsp



Hand-Flex Coaxial Cable

086-10SBSM+

Straight SMA Female Bulkhead to Straight SMA Male

Typical Performance Data

FREQUENCY (MHz)	INSERTION LOSS (dB)	SMA-MALE RETURN LOSS (dB)	SMA-FEMALE BULKHEAD RETURN LOSS (dB)
100.0	0.05	40.3	40.4
200.0	0.08	35.5	35.5
300.0	0.10	34.9	34.9
400.0	0.12	39.1	39.5
500.0	0.13	49.4	45.6
600.0	0.15	35.6	36.4
700.0	0.17	32.2	33.6
800.0	0.18	33.9	34.8
900.0	0.19	44.9	40.6
1000.0	0.20	37.8	38.4
1100.0	0.22	32.0	33.4
1200.0	0.23	31.1	32.3
1300.0	0.23	34.6	34.7
1400.0	0.24	41.3	40.3
1500.0	0.25	34.9	37.0
1600.0	0.26	31.8	33.3
1700.0	0.27	32.6	33.3
1800.0	0.27	35.9	36.1
1900.0	0.28	34.9	37.5
2000.0	0.30	32.0	34.3
2400.0	0.32	33.5	37.3
3000.0	0.36	30.4	31.6
4000.0	0.42	27.9	29.3
5000.0	0.49	25.2	25.6
6000.0	0.54	28.8	28.7
7000.0	0.57	35.5	32.7
8000.0	0.61	31.9	30.0
9000.0	0.66	25.9	24.6
10000.0	0.70	25.2	24.7
11000.0	0.72	24.1	27.2
12000.0	0.77	27.8	39.3
13000.0	0.81	29.6	31.8
14000.0	0.90	25.1	35.9
15000.0	0.92	25.5	28.5
16000.0	0.92	27.4	26.7
17000.0	0.97	35.4	35.2
18000.0	1.02	25.2	24.6



P.O. Box 350166, Brooklyn, New York 11235-0003 (718) 934-4500 • Fax (718) 332-4661 For detailed performance specs & shopping online see Mini-Circuits web site



The Design Engineers Search Engine Provides ACTUAL Data Instantly From MINI-CIRCUITS At: www.minicircuits.com

IF/RF MICROWAVE COMPONENTS

REV. OR
086-10SBSM+
5/21/2013
Page 1 of 1

Hand-Flex Coaxial Cable

086-10SBSM+

Straight SMA Female Bulkhead to Straight SMA Male

Typical Performance Curves

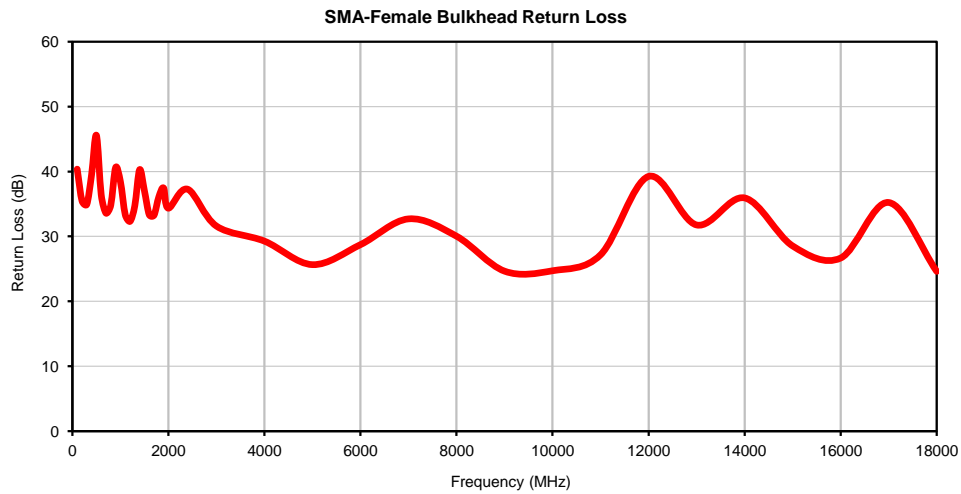
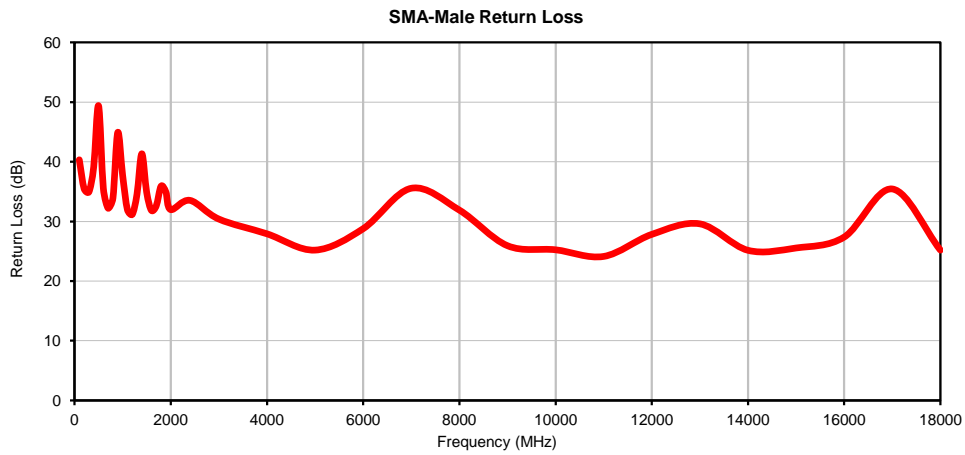

P.O. Box 350166, Brooklyn, New York 11235-0003 • (718) 934-4500 • Fax (718) 332-4661 For detailed performance specs & shopping online see Mini-Circuits web site www.minicircuits.com



The Design Engineers Search Engine Provides ACTUAL Data Instantly From MINI-CIRCUITS At: www.minicircuits.com

IF/RF MICROWAVE COMPONENTS

REV. OR
086-10SBSM+
5/21/2013
Page 1 of 1

Outline Dimensions

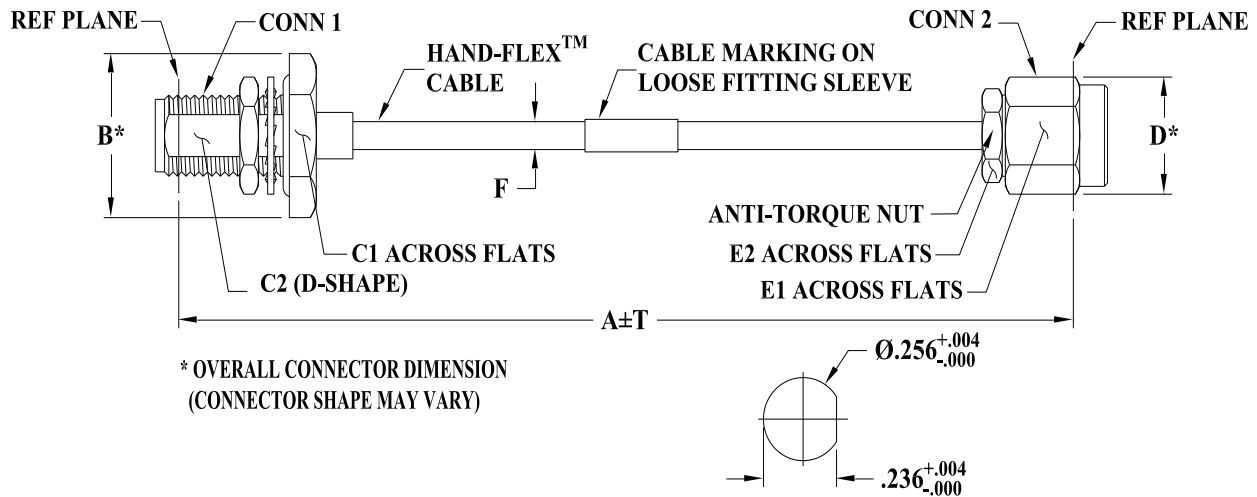

* OVERALL CONNECTOR DIMENSION
(CONNECTOR SHAPE MAY VARY)

CUT OUT FOR SMA FEMALE BULKHEAD CONNECTOR
PANEL THICKNESS .100 MAX INCHES

KP1567 SERIES
SMA FEMALE BULKHEAD (CONN-1)
SMA MALE (CONN-2)

CASE STYLE #	A		B	C1	C2	D	E1	E2	F		T		WEIGHT GRAMS
	INCH	MM							086U-ASM+	086-ASM+	INCH	MM	
KP1567-3	3.00	76.20	.51 (12.95)	.438 (11.13)	.232 (5.89)	.36 (9.14)	.313 (7.95)	.250 (6.35)	.089 ∇ .002 (2.26 ∇ .06)	.108 NOM (2.75 NOM)	.05	1.27	7.37
KP1567-5	5.00	127.00									.05	1.27	8.29
KP1567-6	6.00	152.40									.05	1.27	8.74
KP1567-7	7.00	177.80									.10	2.54	9.20
KP1567-8	8.00	203.20									.10	2.54	9.66
KP1567-9	9.00	228.60									.10	2.54	10.11
KP1567-10	10.00	254.00									.10	2.54	10.57
KP1567-11	11.00	279.40									.10	2.54	11.03
KP1567-12	12.00	304.80									.10	2.54	11.48
KP1567-13	13.00	330.20									.15	3.81	11.94
KP1567-14	14.00	355.60									.15	3.81	12.40
KP1567-16	16.00	406.40									.15	3.81	13.31

Unless otherwise specified dimensions are in inches (mm).

Tolerances: 2Pl. \pm .03; 3Pl. \pm .015

Note:

1. 086 Hand-Flex™ Coaxial Cable.
2. "A" represents length of cable.



All Mini-Circuits products are manufactured under exacting quality assurance and control standards, and are capable of meeting published specifications after being subjected to any or all of the following physical and environmental test.

Specification	Test/Inspection Condition	Reference/Spec
Operating Temperature	-55° to 105° C or -55° to 85° C (see datasheet) Ambient Environment	Individual Model Data sheet
Storage Temperature	-55° to 105° C or -55° to 85° C (see data sheet) Ambient Environment	Individual Model Data Sheet
Thermal Shock	-55° to 100°C, 100 Cycles	MIL-STD-202F; Method 107G
Multiple Bend Radius	40 mm, 5 times for 141 series cables 30 mm, 5 times for 086 series cables	
Single Bend Radius	8 mm for 141 series cables 6 mm for 086 series cables	