



HAND FLEX™

Coaxial Cable

141-8SMNM+

Mini-Circuits

50Ω 8 inch DC to 18 GHz SMA Male to N-Type Male

THE BIG DEAL

- Wideband Frequency Coverage, DC to 18 GHz
- Low Insertion Loss, 0.86 dB Typ. at 18 GHz
- Excellent Return Loss, 18 dB Typ. at 18 GHz
- Hand Formable to Almost Any Custom Shape Without Special Bending Tools
- 8 mm Bend Radius for Tight Installations
- Anti-Torque Nut Prevents Cable Stress During Installation
- Insulated Outer Jacket Standard
- Ideal for Interconnect of Assembled Systems

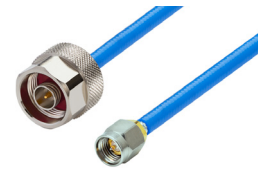

Generic photo used for illustration purposes only

Model No.	141-8SMNM+
Case Style	KQ1668-8
Connectors	SMA Male to N-Type Male

+RoHS Compliant

The +Suffix identifies RoHS Compliance. See our website for methodologies and qualifications

APPLICATIONS

- Replacement for Custom Bent 0.141" Semi-Rigid Cables
- Communication Receivers and Transmitters
- Military and Aerospace System
- Environmental and Test Chambers

PRODUCT OVERVIEW

Mini-Circuits' 141 SMNM+ Series Hand-Flex™ Coaxial Cables are ideal for integrating coaxial components and sub-systems in tight spaces and dense system configurations. SMA to N-type connection avoids need for an adapter between components with SMA female and N-type female connection ports, reducing system cost and improving reliability. Sturdy, hand-formable cable construction maintains shape after bending with bend radius as small as 8 mm. 141 SMNM+ coaxial cables have the advantages of wide frequency range and excellent return loss and insertion loss. Available in a variety of lengths.

KEY FEATURES

Features	Advantages
Hand Formable	141 SMNM+ Series Hand-Flex cables avoid the need for cable-bending tools, alleviating the risk of damage during bending processes typical of semi-rigid cable assemblies.
Tight Bend Radius	Capable of bending to radii as small as 8 mm, the 141 SMNM+ Series is ideal for making connections in tight spaces and dense system assemblies.
Excellent Return Loss	Typical return loss of 25 dB to 6 GHz and 18 dB to 18 GHz makes the 141 SMNM+ Series ideal for interconnecting a wide variety of RF components while minimizing VSWR ripple contribution due to mating cables & connectors.
High Power Handling Capability: <ul style="list-style-type: none"> • 546 W at 0.5 GHz • 90 W at 18 GHz 	Mini-Circuits' 141 SMNM+ Series cables can support medium to high RF power levels and can be used in the transmit path. (NOTE: Power rating at sea level.)
Built-In Anti-Torque Nut	Supports the connector bodies during installation, preventing stress to the connector/cable interface.
SMA Male/N-Type Male Connectors	Eliminates need for adapter when connecting to SMA female and N-type female connectors, reducing cost and improving reliability.

REV. C
ECO-018755
141-8SMNM+
MCL NY
260415





Coaxial Cable

141-8SMNM+

50Ω 8 inch DC to 18 GHz SMA Male to N-Type Male

ELECTRICAL SPECIFICATIONS AT +25 °C

Parameter	Frequency (GHz)	Min.	Typ.	Max.	Units
Frequency Range		DC		18	GHz
Length ¹		8			inches
Insertion Loss	DC-2	-	0.18	0.31	dB
	2-6	-	0.42	0.56	
	6-10	-	0.54	0.74	
	10-18	-	0.86	1.04	
Return Loss	DC-2	23	29	-	dB
	2-6	23	26	-	
	6-10	17	25	-	
	10-18	17	18	-	

1. Custom sizes available, consult factory.

ABSOLUTE MAXIMUM RATINGS²

Parameter	Ratings
Operating Temperature	-55 °C to +105 °C
Storage Temperature	-55 °C to +105 °C
Power Handling at +25 °C, Sea Level	546 W at 0.5 GHz 387 W at 1 GHz 273 W at 2 GHz 156 W at 6 GHz 121 W at 10 GHz 90 W at 18 GHz

2. Permanent damage may occur if any of these limits are exceeded.



CABLE CONSTRUCTION

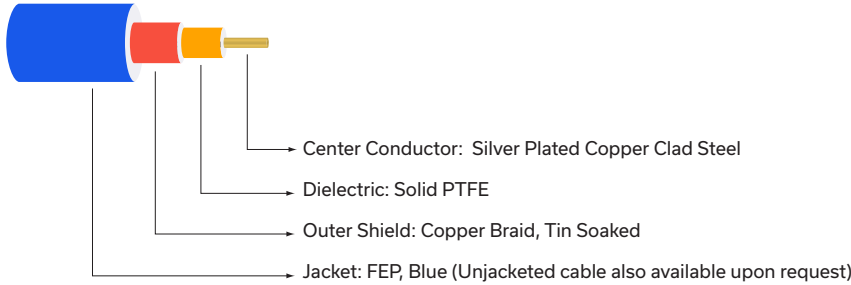

SMA Male Connector:
 Coupling Nut: Stainless Steel Passivated
 Body: Stainless Steel Gold Plated
 Center Pin: Silver Plated Copper Clad Steel

N-Type Male Connector:
 Coupling Nut: Brass, Nickel Plated
 Body: Brass, Nickel Plated
 Center Pin: Brass, Gold Plated

OUTLINE DRAWING

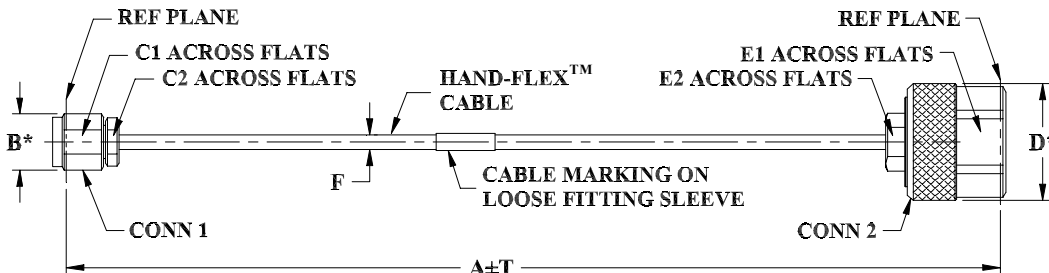

* OVERALL CONNECTOR DIMENSION
 [CONNECTOR SHAPE MAY VARY]

OUTLINE DIMENSIONS (Inch/mm)

A	B	C1	C2	D	E1	E2	F	T	wt
8.0	.36	.313	.250	.88	.750	.375	.163±.004	.10	grams
203.20	9.14	7.95	6.35	22.35	19.05	9.53	4.14±0.10	2.54	42.44



HAND FLEX™

Coaxial Cable

141-8SMNM+

Mini-Circuits

50Ω 8 inch DC to 18 GHz SMA Male to N-Type Male

TYPICAL PERFORMANCE DATA AND CHARTS

Frequency (MHz)	Insertion Loss (dB)	Return Loss (dB)	
		SMA Male	N-Type Male
100	0.02	37.6	38.5
1000	0.09	33.3	33.1
1800	0.10	33.0	36.4
2404	0.14	30.5	31.5
4001	0.22	29.2	31.9
5000	0.23	31.2	31.2
6000	0.30	29.5	26.4
7001	0.33	38.2	41.1
8001	0.33	34.3	36.4
9000	0.43	35.0	32.2
10000	0.42	25.7	25.9
12001	0.56	29.3	30.0
14001	0.46	30.3	31.2
16242	0.62	23.6	26.2
18000	0.69	19.3	22.4

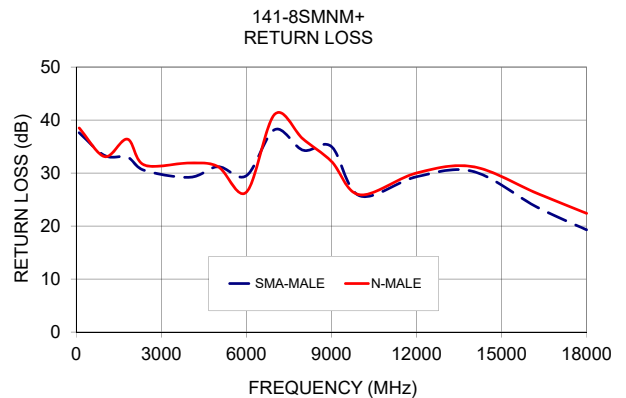
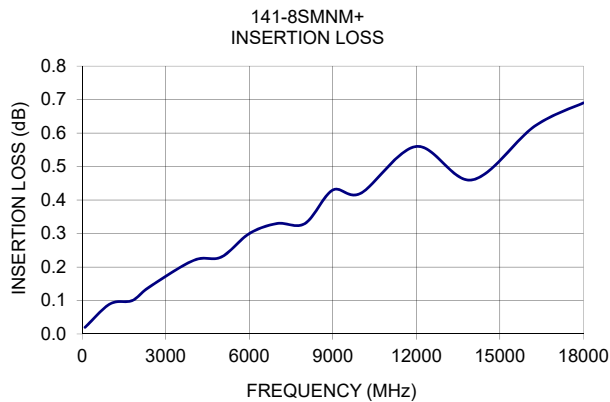



PROPER CABLE CONNECTION USING ANTI-TORQUE NUT

Mini-Circuits' 141 Series Hand-Flex interconnect cables are constructed with an anti-torque nut adjacent to the connector coupling nut. When used properly, this feature prevents possible damage to the cable due to torquing and twisting when tightening the cable connector.

TO PROPERLY TIGHTEN THE CABLE CONNECTOR:

1) The cable connector includes a coupling nut which rotates to fasten the connector, and an anti-torque nut, which is fixed to prevent the cable from twisting during connection.

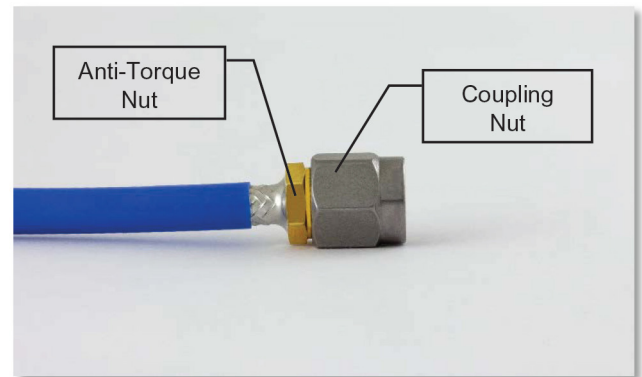

2) To properly tighten the cable, use a standard 1/4 inch open end wrench to brace the anti-torque nut.

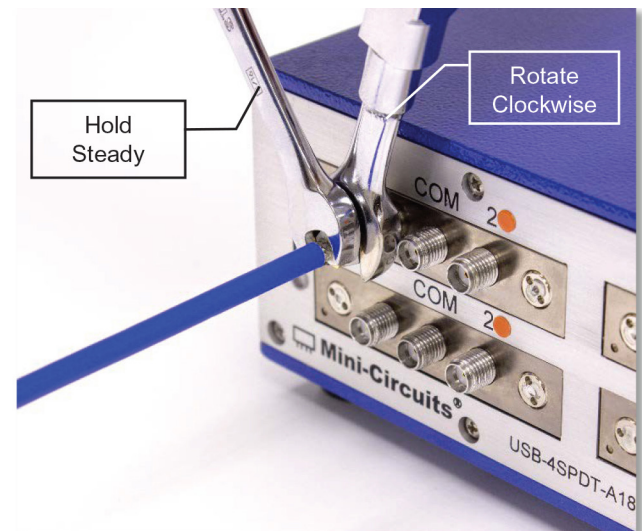

3) Using a 5/16-inch open end wrench, rotate the coupling nut clockwise to tighten the cable connector.

*NOTE: Mini-Circuits recommends using a 5/16-inch open end wrench calibrated to 8 inch-pounds maximum torque to prevent damage due to over-torquing the connector.

NOTES

- A. Performance and quality attributes and conditions not expressly stated in this specification document are intended to be excluded and do not form a part of this specification document.
- B. Electrical specifications and performance data contained in this specification document are based on Mini-Circuit's applicable established test performance criteria and measurement instructions.
- C. The parts covered by this specification document are subject to Mini-Circuits standard limited warranty and terms and conditions (collectively, "Standard Terms"); Purchasers of this part are entitled to the rights and benefits contained therein. For a full statement of the standard terms and the exclusive rights and remedies thereunder, please visit Mini-Circuits' website at www.minicircuits.com/terms/viewterm.html

Typical Performance Data

FREQUENCY (MHz)	INSERTION LOSS (dB)	SMA-MALE RETURN LOSS (dB)	N-MALE RETURN LOSS (dB)
100.0	0.02	37.6	38.5
200.0	0.03	32.8	33.6
300.0	0.04	31.1	31.7
500.0	0.06	38.4	38.8
600.0	0.07	45.0	46.8
800.0	0.09	31.7	31.7
900.0	0.09	31.0	31.0
1000.0	0.09	33.3	33.1
1200.0	0.10	39.7	42.1
1400.0	0.10	30.8	32.5
1600.0	0.10	34.4	33.5
1800.0	0.10	33.0	36.4
2000.0	0.12	29.8	30.5
2200.0	0.13	31.1	31.0
2400.0	0.14	30.6	31.5
2600.0	0.15	32.4	31.9
2800.0	0.17	32.6	33.3
3000.0	0.18	30.0	30.6
3500.0	0.20	28.1	29.4
4000.0	0.22	30.0	32.6
4500.0	0.23	31.5	33.2
5000.0	0.27	31.2	30.9
5500.0	0.29	31.3	28.5
6000.0	0.30	29.5	26.4
6500.0	0.31	36.2	33.4
7000.0	0.33	38.3	40.6
7500.0	0.34	35.3	37.0
8000.0	0.34	34.0	35.9
8500.0	0.36	32.4	31.1
9000.0	0.42	33.9	31.8
9500.0	0.38	30.1	30.6
10000.0	0.42	25.7	25.9
10500.0	0.43	27.1	28.1
11000.0	0.49	29.3	30.4
11500.0	0.50	25.2	25.6
12000.0	0.42	29.3	29.8
12500.0	0.47	25.6	26.0
13000.0	0.46	24.4	24.4
13500.0	0.45	25.5	24.6
14000.0	0.49	30.0	30.3
14500.0	0.57	26.0	26.9
15000.0	0.44	21.4	27.9
16000.0	0.41	21.8	24.6
16500.0	0.55	24.4	26.4
17500.0	0.67	24.7	25.8
18000.0	0.69	19.3	22.4

Typical Performance Curves

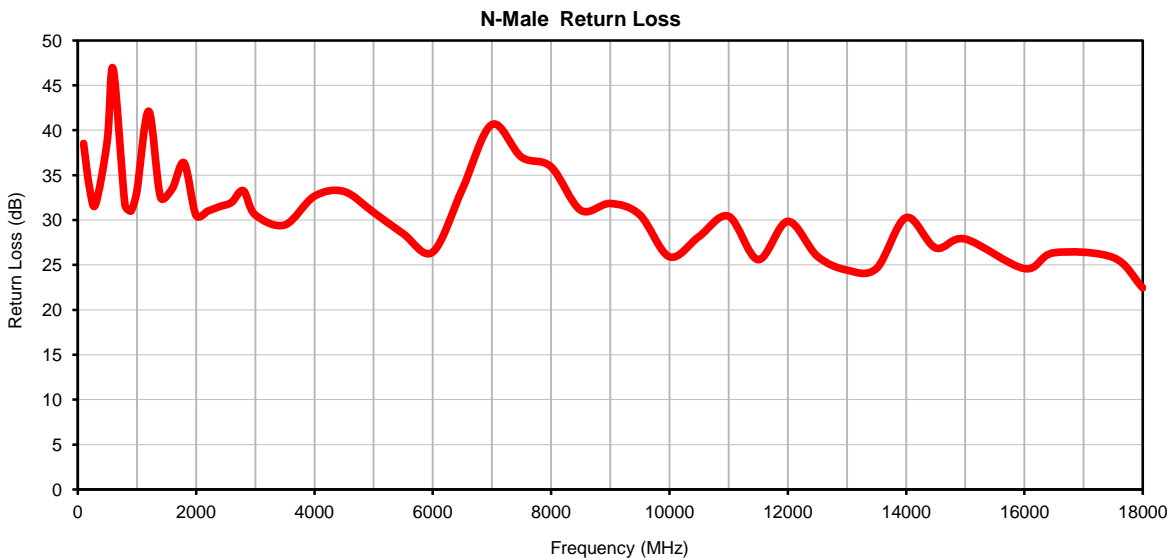
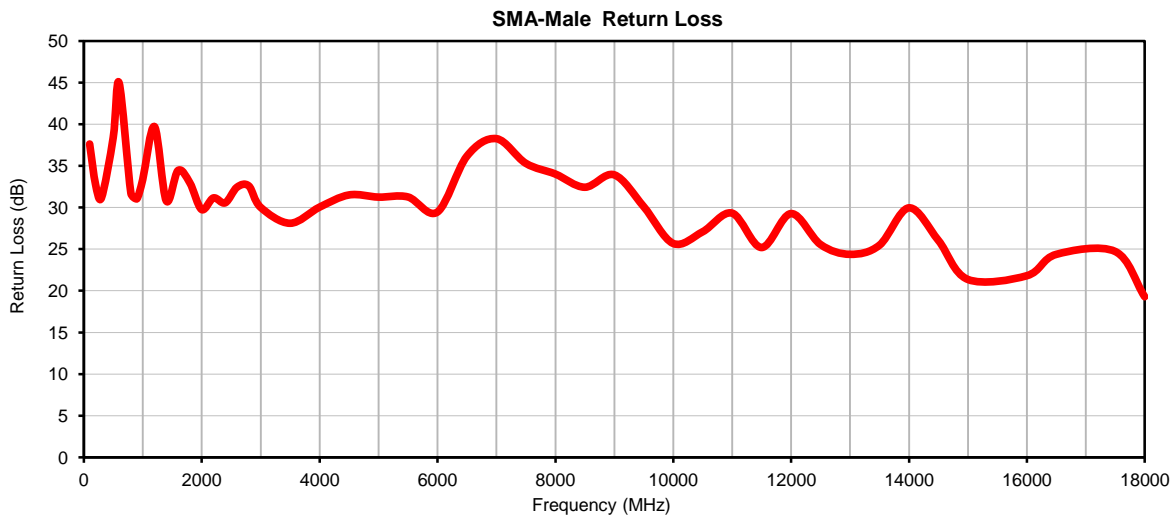

Outline Dimensions

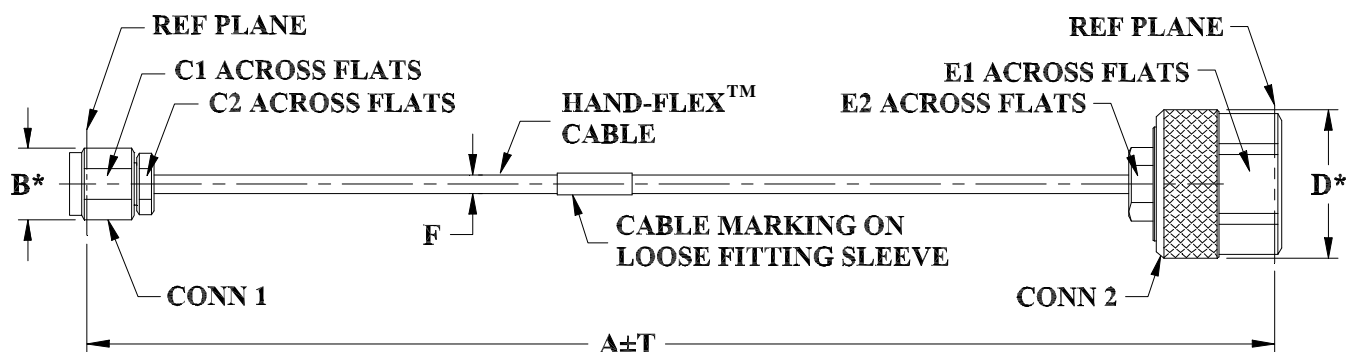

* OVERALL CONNECTOR DIMENSION
[CONNECTOR SHAPE MAY VARY]

KQ1668 SERIES
SMA MALE (CONN-1)
N MALE (CONN-2)

CASE STYLE #	A		B	C1	C2	D	E1	E2	F		T		WEIGHT GRAMS
	INCH	MM							141U-ASMNM+	141-ASMNM+	INCH	MM	
KQ1668-4	4.00	101.60	.36 (9.14)	.313 (7.95)	.250 (6.35)	.88 (22.35)	.750 (19.05)	.375 (9.53)	.141±.003 (3.58±0.07)	.163±.004 (4.14±0.10)	.05	1.27	37.87
KQ1668-5	5.00	127.00									.05	1.27	39.02
KQ1668-6	6.00	152.00									.05	1.27	40.16
KQ1668-7	7.00	177.80									.10	2.54	41.30
KQ1668-8	8.00	203.20									.10	2.54	42.44
KQ1668-10	10.00	254.00									.10	2.54	44.73
KQ1668-12	12.00	304.80									.10	2.54	47.02
KQ1668-18	18.00	457.20									.15	3.81	53.87
KQ1668-24	24.00	609.60									.15	3.81	60.73

Unless otherwise specified dimensions are in inches (mm).

Tolerances: 2Pl. ± .03; 3Pl. ± .015

Note:

1. 141 Hand-Flex™ Coaxial Cable.
2. "A" Represents Length of Cable.



All Mini-Circuits products are manufactured under exacting quality assurance and control standards, and are capable of meeting published specifications after being subjected to any or all of the following physical and environmental test.

Specification	Test/Inspection Condition	Reference/Spec
Operating Temperature	-55° to 105°C Ambient Environment	Individual Model Data Sheet
Storage Temperature	-55° to 105°C Ambient Environment	Individual Model Data Sheet
Thermal Shock	-55° to 100°C, 50 Cycles	MIL-STD-202F; Method 107G
Multiple Bend Radius	40 mm, 5 times for 141 series cables 30 mm, 5 times for 086 series cables	
Single Bend Radius	8 mm for 141 series cables 6 mm for 086 series cables	