

# Surface Mount Directional Coupler

75Ω 40 to 1000 MHz

## ADC-20-4-75R+



Generic photo used for illustration purposes only

CASE STYLE: CD636

**+RoHS Compliant**

The +Suffix identifies RoHS Compliance. See our web site for RoHS Compliance methodologies and qualifications



Available Tape and Reel at no extra cost

Reel Size	Devices/Reel
7"	20, 50, 100, 200
13"	500, 1000

### Maximum Ratings

Operating Temperature	-40°C to 85°C
Storage Temperature	-55°C to 100°C

Permanent damage may occur if any of these limits are exceeded.

### Pin Connections

INPUT	1
OUTPUT	6
COUPLED	3
GROUND	2,5
NOT USED	4

### Outline Drawing

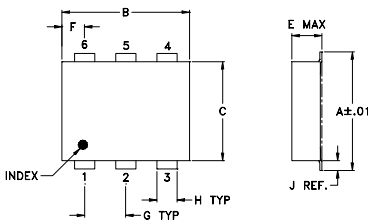

### PCB Land Pattern

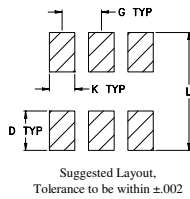

### Outline Dimensions (inch/mm)

A	B	C	D	E	F	G
.272	.310	.220	.100	.162	.055	.100
6.91	7.87	5.59	2.54	4.11	1.40	2.54
H	J	K	L	wt		
.030	.026	.065	.300	grams		
0.76	0.66	1.65	7.62	0.25		

### Demo Board MCL P/N: TB-356 Suggested PCB Layout (PL-213)

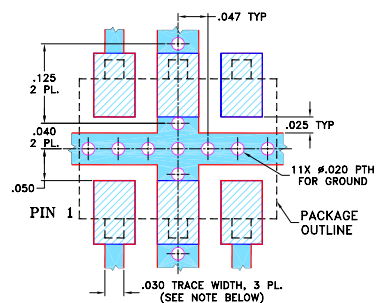

- NOTES:
- TRACE WIDTH IS SHOWN FOR ROGERS RO4350B WITH DIELECTRIC THICKNESS .030" ± .002"; COPPER: 1/2 OZ. EACH SIDE. FOR OTHER MATERIALS TRACE WIDTH MAY NEED TO BE MODIFIED.
  - BOTTOM SIDE OF THE PCB IS CONTINUOUS GROUND PLANE.
  - DENOTES PCB COPPER LAYOUT WITH SMOBS (SOLDER MASK OVER BARE COPPER)
  - DENOTES COPPER LAND PATTERN FREE OF SOLDER MASK

### Features

- wideband, 40-1000 MHz
- low mainline loss, 0.6 dB typ.
- excellent VSWR, 1.1:1 typ.
- internal load, no external components required
- protected by U.S. Patents 6,133,525 & 6,140,887

### Applications

- cable tv

### Directional Coupler Electrical Specifications

FREQ. (MHz)	COUPLING (dB)		MAINLINE LOSS <sup>1</sup> (dB)			DIRECTIVITY (dB)			VSWR (:1)	POWER INPUT, W							
	Nom.	Flatness	L	M	U	L	M	U		Typ.	L	MU					
f <sub>L</sub> -f <sub>U</sub>			Typ.	Max.	Typ.	Max.	Typ.	Max.	Typ.	Max.	Max.						
40-1000	20.5±0.5	±0.8	0.5	0.8	0.6	0.9	0.7	1.2	24	17	20	15	17	12	1.10	1.0	1.0

L= 40-400 MHz M= 400-500 MHz U= 500-1000 MHz  
1. Mainline loss includes theoretical power loss at coupled port.

### Typical Performance Data

Frequency (MHz)	Mainline Loss (dB) In-Out	Coupling (dB) In-Cpl	Directivity (dB)	Return Loss (dB)		
				In	Out	Cpl
40.00	0.57	20.74	24.46	24.97	25.29	25.60
100.00	0.52	20.82	24.90	29.34	29.25	28.73
220.00	0.50	20.87	23.92	28.31	29.17	31.75
340.00	0.53	20.82	22.10	26.02	26.77	39.90
450.00	0.56	20.73	20.26	24.23	25.60	41.94
560.00	0.62	20.59	18.57	25.31	24.40	37.70
680.00	0.68	20.42	17.84	30.01	23.08	36.42
800.00	0.71	20.23	17.23	27.10	23.22	30.86
900.00	0.74	20.07	16.93	23.57	23.74	28.67
1000.00	0.77	19.86	16.53	25.62	24.50	27.23

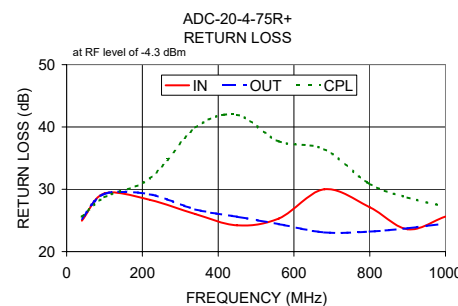
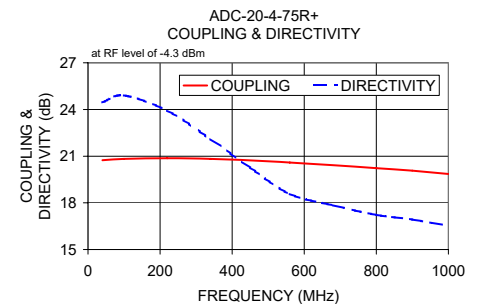
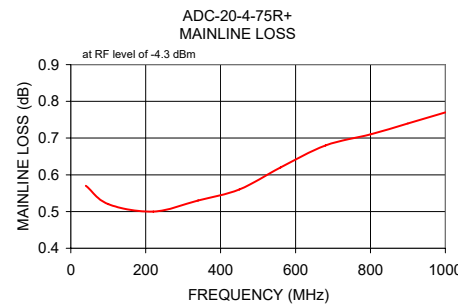

### Electrical Schematic

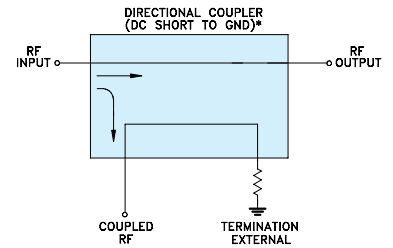

\* ELECTRICAL SCHEMATIC IS FOR DIRECTIONAL COUPLER WITH INTERNAL TRANSFORMER(S) AND EXTERNAL TERMINATION.

### Notes

- Performance and quality attributes and conditions not expressly stated in this specification document are intended to be excluded and do not form a part of this specification document.
- Electrical specifications and performance data contained in this specification document are based on Mini-Circuits' applicable established test performance criteria and measurement instructions.
- The parts covered by this specification document are subject to Mini-Circuits standard limited warranty and terms and conditions (collectively, "Standard Terms"); Purchasers of this part are entitled to the rights and benefits contained therein. For a full statement of the Standard Terms and the exclusive rights and remedies thereunder, please visit Mini-Circuits' website at [www.minicircuits.com/MCLStore/terms.jsp](http://www.minicircuits.com/MCLStore/terms.jsp)



# Directional Coupler

# ADC-20-4-75R+

## Typical Performance Data

TEST CONDITIONS: INPUT POWER =0 dBm @Temperature = +25°C

FREQUENCY (MHz)	INSERTION LOSS (dB)	COUPLING LOSS (dB)	DIRECTIVITY (dB)	RETURN LOSS (dB)		
				IN	OUT	CPL
10	0.56	20.70	21.41	19.24	19.29	20.38
20	0.55	20.77	23.52	22.91	23.20	23.37
30	0.54	20.81	24.20	24.78	25.27	24.92
40	0.52	20.83	24.50	26.16	26.78	26.06
50	0.51	20.85	24.56	27.31	28.06	26.98
75	0.50	20.90	24.44	29.62	30.74	28.86
100	0.49	20.92	24.31	31.13	32.57	30.31
150	0.50	20.93	23.45	31.30	32.46	32.48
175	0.50	20.94	22.78	30.61	31.28	33.42
200	0.51	20.94	22.31	29.69	30.06	34.17
250	0.52	20.92	21.29	27.89	27.79	35.14
275	0.52	20.90	20.77	27.01	26.90	35.41
300	0.53	20.88	20.35	26.24	26.11	35.52
325	0.54	20.86	20.12	25.59	25.40	35.44
350	0.55	20.85	19.51	25.03	24.77	35.11
375	0.55	20.82	19.17	24.52	24.26	34.44
400	0.56	20.79	18.80	24.05	23.78	33.55
450	0.58	20.72	17.98	23.36	23.07	31.86
475	0.59	20.69	17.72	23.11	22.75	31.22
500	0.60	20.65	17.29	22.89	22.52	30.69
550	0.62	20.58	16.71	22.54	22.16	29.54
575	0.63	20.53	16.65	22.43	22.04	28.88
600	0.64	20.50	16.18	22.36	21.97	28.20
650	0.67	20.41	15.78	22.38	21.97	27.17
700	0.69	20.32	15.51	22.61	22.10	26.50
750	0.71	20.20	15.38	23.05	22.44	25.73
800	0.72	20.10	15.26	23.57	22.89	24.98
850	0.73	19.98	15.06	24.32	23.46	24.43
900	0.75	19.86	15.10	25.31	24.32	24.04
950	0.76	19.74	14.99	26.56	25.20	23.60
975	0.76	19.67	15.20	27.20	25.77	23.45
1000	0.78	19.61	15.22	28.07	26.39	23.33
1025	0.78	19.59	14.76	28.83	26.92	23.25
1050	0.79	19.49	15.21	29.86	27.53	23.25
1100	0.80	19.38	15.04	31.97	28.86	23.23
1150	0.82	19.27	14.66	34.56	30.33	23.21
1200	0.83	19.14	14.01	37.01	31.61	23.22
1250	0.86	19.05	13.09	36.73	32.39	23.38
1300	0.89	18.93	12.40	34.61	32.77	23.77
1400	0.93	18.66	10.84	31.58	31.91	24.58
1500	0.97	18.40	9.75	29.27	30.76	26.18
1600	0.99	18.18	8.66	27.84	29.56	27.94
1700	1.04	18.03	8.25	26.99	27.91	31.31
1800	1.11	17.92	8.18	25.99	26.11	37.08
1900	1.21	17.81	8.59	25.13	24.14	43.88
2000	1.32	17.76	9.34	23.74	22.17	36.73
2200	1.35	17.83	9.18	20.79	18.44	27.04
2400	1.19	17.94	6.16	18.11	15.28	22.80
2500	1.16	17.84	4.46	17.38	14.29	21.88
2600	1.23	17.63	3.84	17.00	13.51	20.15
2800	1.95	17.22	3.75	16.39	12.08	18.14
3000	2.70	17.09	7.21	16.76	11.39	17.00
3250	2.45	16.23	10.40	19.48	12.11	16.51
3500	1.71	18.14	0.06	18.00	11.57	16.81

REV. X1  
ADC-20-4-75R+  
080914  
Page 1 of 3



IF/RF MICROWAVE COMPONENTS • ISO 9001 ISO 14001 AS 9100 CERTIFIED • RoHS compliant

P.O. Box 350166, Brooklyn, New York 11235-0003 (718) 934-4500 Fax (718) 332-4661



The Design Engineers Search Engine finds the model you need, Instantly • For detailed performance specs & shopping online see



# Directional Coupler

# ADC-20-4-75R+

## Typical Performance Data

TEST CONDITIONS: INPUT POWER =0 dBm @Temperature = -40°C

FREQUENCY (MHz)	INSERTION LOSS (dB)	COUPLING LOSS (dB)	DIRECTIVITY (dB)	RETURN LOSS (dB)		
				IN	OUT	CPL
10	0.36	20.59	20.04	18.80	18.52	19.38
20	0.43	20.71	23.90	24.38	23.76	24.52
30	0.44	20.75	24.76	27.62	26.45	27.14
40	0.44	20.79	25.04	30.13	28.40	29.14
50	0.43	20.81	25.04	32.03	30.14	30.46
75	0.43	20.84	25.10	33.24	34.71	30.65
100	0.42	20.86	24.85	33.26	40.71	30.13
150	0.42	20.88	23.99	35.73	41.89	35.01
175	0.42	20.88	23.30	36.58	38.91	39.16
200	0.43	20.88	22.91	36.88	36.66	38.01
250	0.44	20.86	21.81	31.04	32.53	36.54
275	0.44	20.84	21.32	28.84	30.63	38.22
300	0.45	20.83	20.90	27.87	29.00	40.83
325	0.45	20.79	20.63	27.40	27.56	42.58
350	0.46	20.78	20.06	26.39	26.35	40.27
375	0.46	20.75	19.71	25.06	25.32	36.91
400	0.47	20.71	19.33	24.00	24.42	34.52
450	0.49	20.65	18.56	23.04	23.17	32.65
475	0.50	20.61	18.35	22.49	22.66	31.71
500	0.50	20.58	17.86	21.86	22.26	30.29
550	0.52	20.49	17.29	21.09	21.64	27.99
575	0.53	20.45	17.42	20.93	21.38	27.31
600	0.54	20.41	16.86	20.71	21.17	26.51
650	0.57	20.32	16.61	20.41	20.86	24.82
700	0.58	20.21	16.36	20.61	20.76	24.04
750	0.60	20.11	16.36	20.88	20.90	23.02
800	0.61	20.00	16.43	21.75	21.36	21.88
850	0.62	19.88	16.42	22.89	22.05	21.42
900	0.63	19.76	16.57	24.35	23.13	20.80
950	0.64	19.63	16.59	27.26	24.44	20.31
975	0.64	19.56	17.00	29.00	25.21	20.27
1000	0.65	19.50	17.16	30.97	26.09	20.26
1025	0.65	19.46	16.82	33.03	26.90	20.31
1050	0.65	19.40	17.35	36.36	27.97	20.47
1100	0.66	19.28	17.34	42.69	30.05	20.86
1150	0.68	19.17	16.96	33.73	31.99	21.21
1200	0.69	19.04	16.11	28.62	32.58	21.97
1250	0.72	18.93	14.88	26.30	32.15	23.01
1300	0.74	18.82	14.08	25.09	31.73	24.31
1400	0.77	18.56	12.01	23.34	31.83	28.88
1500	0.79	18.31	10.73	23.24	31.81	40.14
1600	0.78	18.11	9.58	23.17	28.24	32.21
1700	0.82	17.95	9.23	24.65	24.12	26.10
1800	0.89	17.88	9.44	24.88	21.33	23.07
1900	0.97	17.76	10.15	25.18	19.75	20.97
2000	1.08	17.69	11.36	29.71	19.12	21.02
2200	1.01	17.77	10.47	26.30	19.14	22.68
2400	0.78	17.92	6.14	15.88	17.82	23.11
2500	0.76	17.87	4.19	13.56	16.20	19.63
2600	0.77	17.63	3.42	12.12	14.62	16.54
2800	1.35	17.21	3.65	10.19	11.31	12.09
3000	2.26	16.91	8.40	11.68	9.36	9.87
3250	1.91	15.95	9.05	22.68	10.75	10.25
3500	0.95	18.34	1.82	11.45	13.16	15.85

REV. X1

ADC-20-4-75R+

080914

Page 2 of 3



IF/RF MICROWAVE COMPONENTS • ISO 9001 ISO 14001 AS 9100 CERTIFIED RoHS compliant

P.O. Box 350166, Brooklyn, New York 11235-0003 (718) 934-4500 Fax (718) 332-4661



The Design Engineers Search Engine finds the model you need, Instantly • For detailed performance specs & shopping online see



# Directional Coupler

# ADC-20-4-75R+

## Typical Performance Data

TEST CONDITIONS: INPUT POWER =0 dBm @Temperature = +85°C

FREQUENCY (MHz)	INSERTION LOSS (dB)	COUPLING LOSS (dB)	DIRECTIVITY (dB)	RETURN LOSS		
				IN (dB)	OUT (dB)	CPL
10	0.75	20.77	20.95	18.39	18.65	19.95
20	0.68	20.84	22.72	21.19	22.01	22.27
30	0.65	20.86	23.29	22.44	23.83	23.27
40	0.63	20.88	23.53	23.21	25.14	23.82
50	0.61	20.90	23.65	23.79	26.13	24.21
75	0.60	20.94	23.60	25.15	27.82	25.43
100	0.59	20.96	23.39	26.77	28.56	27.39
150	0.60	20.98	22.72	28.82	28.35	30.73
175	0.60	21.00	22.03	28.02	27.88	30.28
200	0.61	21.00	21.60	26.85	27.15	29.93
250	0.62	20.99	20.66	26.17	25.79	32.12
275	0.62	20.97	20.21	26.32	25.28	34.16
300	0.63	20.95	19.84	26.21	24.86	35.57
325	0.64	20.95	19.44	25.66	24.47	35.44
350	0.64	20.92	18.99	24.94	24.12	34.48
375	0.65	20.91	18.51	24.54	23.86	33.80
400	0.66	20.88	18.16	24.50	23.65	33.48
450	0.68	20.82	17.31	24.78	23.43	33.49
475	0.69	20.78	17.05	24.55	23.31	33.34
500	0.70	20.76	16.61	24.23	23.25	32.91
550	0.72	20.68	15.97	24.12	23.18	31.86
575	0.73	20.64	15.92	24.33	23.20	31.37
600	0.74	20.61	15.39	24.40	23.20	31.03
650	0.77	20.52	14.94	24.30	23.29	30.70
700	0.79	20.43	14.52	24.26	23.38	30.27
750	0.81	20.34	14.29	24.30	23.52	29.27
800	0.82	20.22	14.12	24.36	23.69	28.81
850	0.84	20.12	13.94	24.45	23.94	28.03
900	0.86	20.00	13.72	24.57	24.30	26.98
950	0.87	19.89	13.51	24.99	24.67	26.34
975	0.87	19.82	13.63	25.24	24.90	25.95
1000	0.89	19.75	13.57	25.56	25.15	25.42
1025	0.89	19.74	13.07	25.86	25.40	25.02
1050	0.90	19.65	13.43	26.23	25.65	24.75
1100	0.91	19.55	13.19	27.36	26.35	24.32
1150	0.93	19.44	12.78	29.14	27.19	23.49
1200	0.95	19.31	12.20	31.36	27.98	22.84
1250	0.97	19.21	11.40	34.71	28.79	22.55
1300	1.00	19.08	10.89	41.08	29.60	22.55
1400	1.06	18.79	9.55	37.29	29.95	22.44
1500	1.10	18.52	8.60	29.53	30.56	23.77
1600	1.15	18.27	7.61	25.72	31.74	25.37
1700	1.21	18.09	7.23	23.59	33.52	29.35
1800	1.30	17.96	7.11	21.94	32.53	31.72
1900	1.39	17.81	7.40	20.76	27.51	29.12
2000	1.50	17.74	7.99	19.64	23.27	23.69
2200	1.55	17.80	7.93	18.16	17.87	19.58
2400	1.46	17.85	5.62	18.51	15.04	18.81
2500	1.48	17.66	4.21	19.52	14.47	19.76
2600	1.60	17.44	3.72	20.94	14.10	20.53
2800	2.38	17.00	3.63	20.40	13.11	23.15
3000	3.03	16.96	6.51	17.39	12.25	21.18
3250	2.74	16.33	10.74	16.88	12.57	16.82
3500	2.15	18.15	1.03	18.95	11.91	15.82

REV. X1  
ADC-20-4-75R+  
080914  
Page 3 of 3



IF/Rf MICROWAVE COMPONENTS • ISO 9001 ISO 14001 AS 9100 CERTIFIED • RoHS compliant  
P.O. Box 350166, Brooklyn, New York 11235-0003 (718) 934-4500 Fax (718) 332-4661



The Design Engineers Search Engine finds the model you need, Instantly • For detailed performance specs & shopping online see



# Directional Coupler

# ADC-20-4-75R+

## Typical Performance Curves

Insertion Loss

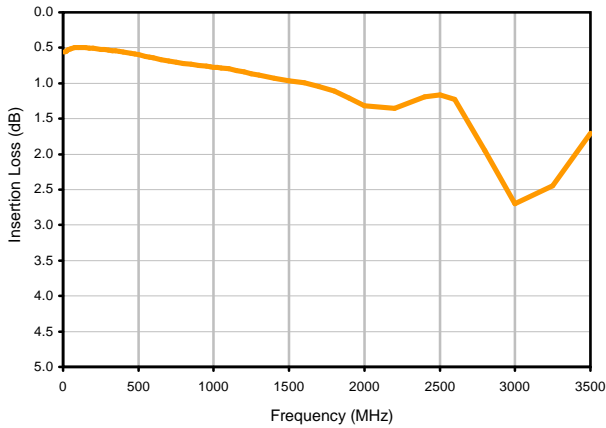

Insertion Loss vs. TEMPERATURE

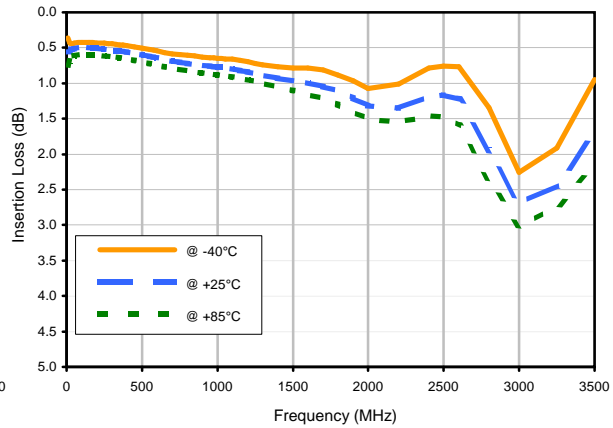

Coupling Loss vs. TEMPERATURE

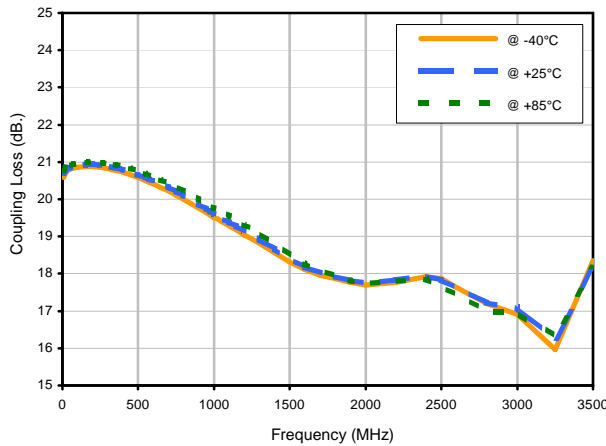

Directivity vs. TEMPERATURE

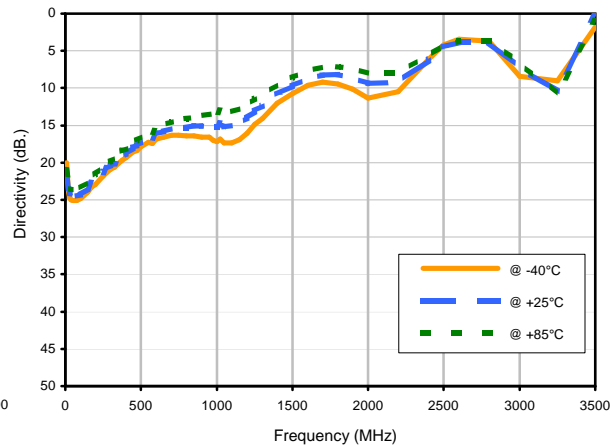

# Directional Coupler

# ADC-20-4-75R+

## Typical Performance Curves

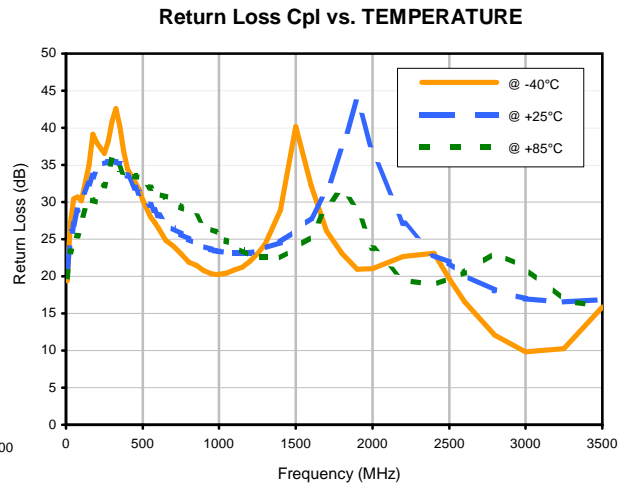
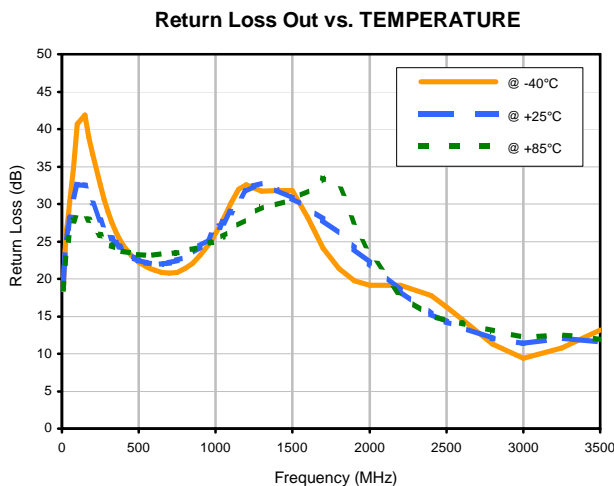
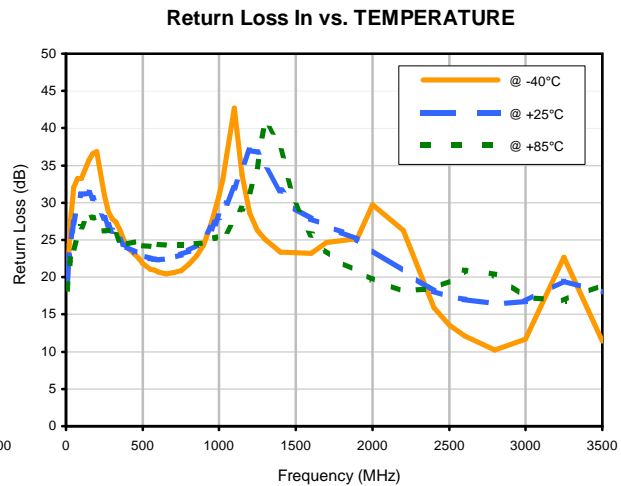

# Case Style

# CD

CD541  
CD542  
CD636  
CD637

## Outline Dimensions

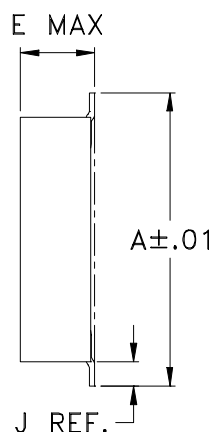

## PCB Land Pattern



Suggested Layout,  
Tolerance to be within  $\pm.002$

CASE#	A	B	C	D	E	F	G	H	J	K	L	WT, GRAM
CD541					.082 (2.08)							.15
CD542	.272 (6.91)	.310 (7.87)	.220 (5.58)	.100 (2.54)	.112 (2.84)	.055 (1.40)	.100 (2.54)	.030 (0.76)	.026 (0.66)	.065 (1.65)	.300 (7.62)	.20
CD636					.162 (4.11)							.25
CD637					.206 (5.23)							.40

Dimensions are in inches (mm). Tolerances: 2 Pl.  $\pm .01$ ; 3 Pl.  $\pm .005$

### Notes:

- Case material: Plastic.
- Termination finish:
  - For RoHS Case Styles: Tin plate over Nickel plate. All models, (+) suffix.
  - For RoHS-5 Case Styles: Tin-Lead plate. All models, no (+) suffix.

**Mini-Circuits**

INTERNET <http://www.minicircuits.com>

P.O. Box 350166, Brooklyn, New York 11235-0003 (718) 934-4500 Fax (718) 332-4661

Distribution Centers NORTH AMERICA 800-654-7949 • 417-335-5935 • Fax 417-335-5945 • EUROPE 44-1252-832600 • Fax 44-1252-837010

Mini-Circuits ISO 9001 & ISO 14001 Certified

# Tape & Reel Packaging TR-F34



Tape Width, mm	Device Cavity Pitch, mm	Reel Size, inches	Devices per Reel see note	
16	12	7	Small quantity standard (see note)	20
				50
				100
				200
		13	Standard	500
				1000

Note: Availability of small reel quantity varies by model.  
Refer to pricing and availability on individual model dashboard.

Mini-Circuits carrier tape materials provide protection from ESD (Electro-Static Discharge) during handling and transportation. Tapes are static dissipative and comply with industry standards EIA-481/EIA-541.

Go to: [www.minicircuits.com/pages/pdfs/tape.pdf](http://www.minicircuits.com/pages/pdfs/tape.pdf)



INTERNET <http://www.minicircuits.com>

P.O. Box 350166, Brooklyn, New York 11235-0003 (718) 934-4500 Fax (718) 332-4661

Distribution Centers NORTH AMERICA 800-654-7949 • 417-335-5935 • Fax 417-335-5945 • EUROPE 44-1252-832600 • Fax 44-1252-837010

Mini-Circuits ISO 9001 & ISO 14001 Certified



THIRD ANGLE PROJECTION

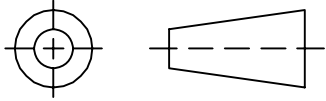

REVISIONS

REV	ECN No.	DESCRIPTION	DATE	DR	AUTH
OR	M100739	NEW RELEASE	02/14/06	MMG	DY

SUGGESTED MOUNTING CONFIGURATION FOR CD636 CASE STYLE, "hz" PIN CONNECTION

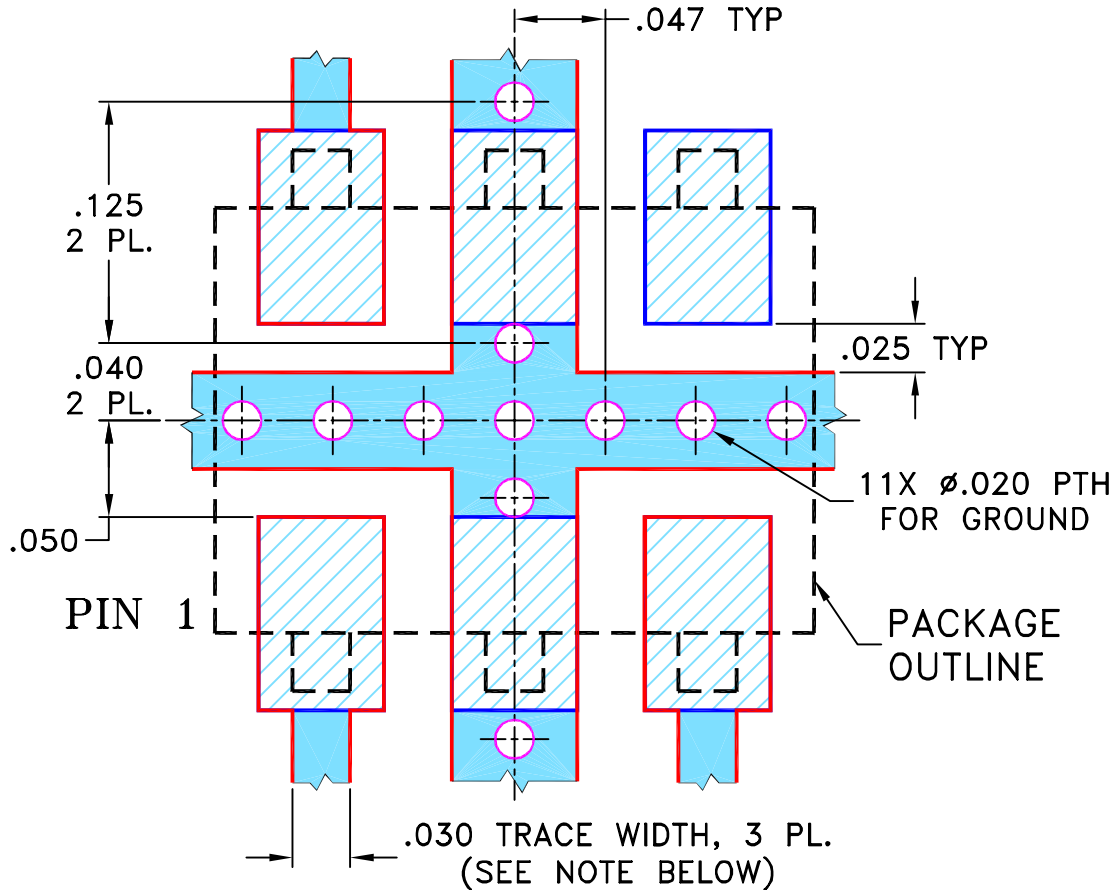

- NOTES:** 1. TRACE WIDTH IS SHOWN FOR ROGERS R04350B WITH DIELECTRIC THICKNESS .030" ± .002"; COPPER: 1/2 OZ. EACH SIDE. FOR OTHER MATERIALS TRACE WIDTH MAY NEED TO BE MODIFIED.  
 2. BOTTOM SIDE OF THE PCB IS CONTINUOUS GROUND PLANE.



DENOTES PCB COPPER LAYOUT WITH SMOBS (SOLDER MASK OVER BARE COPPER)



DENOTES COPPER LAND PATTERN FREE OF SOLDER MASK

UNLESS OTHERWISE SPECIFIED	INITIALS	DATE
DIMENSIONS ARE IN INCHES TOLERANCES ON: 2 PL DECIMALS ± 3 PL DECIMALS ± .005 ANGLES ± FRACTIONS ±	DRAWN	MMG 12/30/05
	CHECKED	AV 02/14/06
	APPROVED	DY 02/14/06



Mini-Circuits®

13 Neptune Avenue  
Brooklyn NY 11235

PL, hz, 75, CD636, ADC, TB-356

SIZE A	CODE IDENT 15542	DRAWING NO: 98-PL-213	REV: OR
FILE:	98PL213	SCALE: 10:1	SHEET: 1 OF 1

Mini-Circuits®  
 THIS DOCUMENT AND ITS CONTENTS ARE THE PROPERTY OF MINI-CIRCUITS. EXCEPT FOR USE EXPRESSLY GRANTED, IN WRITING, TO ITS VENDORS, VENDEE AND THE UNITED STATES GOVERNMENT, MINI-CIRCUITS RESERVES ALL PROPRIETARY DESIGN, USE, MANUFACTURING AND REPRODUCTION RIGHTS THERETO. THESE CONTENTS SHALL NOT BE USED, DUPLICATED OR DISCLOSED TO ANY OUTSIDE PARTY, IN WHOLE OR IN PART, WITHOUT WRITTEN PERMISSION OF MINI-CIRCUITS.

ASHEETA1.DWG REV:A DATE:01/12/95

# Evaluation Board and Circuit

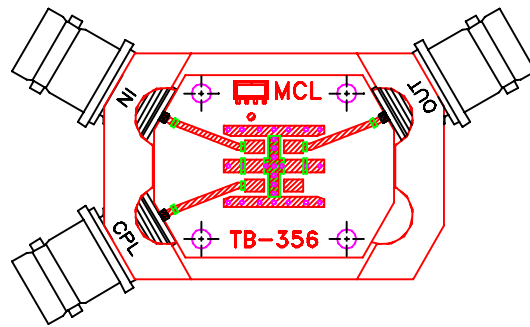

TB-356

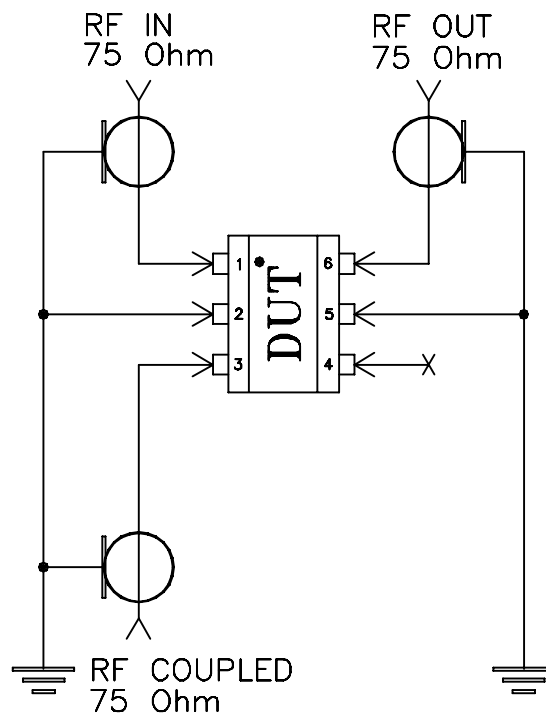

Schematic Diagram

## Notes:

1. 75 Ohm BNC Female connectors.
2. PCB Material: Rogers R04350 or equivalent,  
Dielectric Constant=3.5, Thickness=.030 inch.

 Mini-Circuits®



All Mini-Circuits products are manufactured under exacting quality assurance and control standards, and are capable of meeting published specifications after being subjected to any or all of the following physical and environmental test.

Specification	Test/Inspection Condition	Reference/Spec
Operating Temperature	-40° to 85°C Ambient Environment	Individual Model Data Sheet
Storage Temperature	-55° to 100° C Ambient Environment	Individual Model Data Sheet
Humidity	90 to 95% RH, 240 hours, 50°C	MIL-STD-202, Method 103, Condition A, Except 50°C and end-point electrical test done within 12 hours
Thermal Shock	-55° to 100°C, 100 cycles	MIL-STD-202, Method 107, Condition A-3, except +100°C
Solder Reflow Heat	Sn-Pb Eutetic Process: 225°C peak Pb-Free Process 245° - 250°C peak	J-STD-020, Table 4-1, 4-2 and 5-2, Figure 5-1
Solderability	10X Magnification	J-STD-002, 95% Coverage
Vibration (High Frequency)	20g peak, 10-2000 Hz, 12 times in each of three perpendicular directions (total 36)	MIL-STD-202, Method 204, Condition D
Mechanical Shock	50g, 11 ms, 1/2-sine, 18 shocks: 3 each direction, each of 3 axes	MIL-STD-202, Method 213, Condition A
Marking Resistance to Solvents	Isopropyl alcohol + mineral spirits at 25°C; terpene defluxer at 25°C; distilled water + proylene glycol monomethyl ether + monoethanolamine at 63°C to 70°C	MIL-STD-202, Method 215