

Engineering Development Model

Directional Coupler

ADC-ED10553/1

Important Note

This model has been designed, built and tested in our engineering department. Performance data represents model capability. At present it is a non-catalog model. On request, we can supply a final specification sheet, part number and price/delivery information.



Please click "Back", and then click "Contact Us" for Applications support.

CASE STYLE : CD636

ELECTRICAL SPECIFICATIONS 75Ω/50Ω @ +25°C					
Parameter		Min.	Typ.	Max.	Units
Frequency		10		1000	MHz
Coupling	Nominal		6.0 ± 1.0		dB
	Flatness		± 1.0		dB
Mainline Loss **	10-100 MHz		1.90		dB
	100-500 MHz		2.85		dB
	500-1000 MHz		3.20		dB
Directivity	10-100 MHz		17		dB
	100-500 MHz		17		dB
	500-1000 MHz		14		dB
VSWR	10-1000 MHz		1.4		(:1)
RF Power Input	10-1000 MHz			0.5	W

Notes: **Mainline loss includes theoretical coupled power loss of 1.256 dB at 6 dB coupling.

Input and coupled ports impedance: 75 ohms; Output port impedance: 50 ohms

MAXIMUM RATINGS	
Operating Temperature	-40°C to 85°C
Storage Temperature	-55°C to 100°C

PIN CONNECTIONS	
INPUT	1
OUTPUT	6
COUPLED FORWARD	3
75Ω TERM. EXTERNAL	4
GROUND	2
NOT USED	5

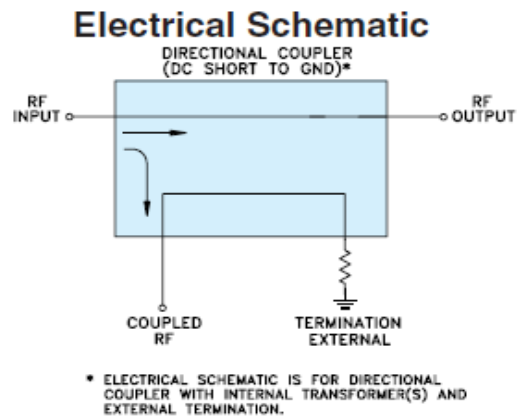

Directional Coupler

ADC-ED10553/1

Typical Performance Data

FREQUENCY (MHz)	INSERTION LOSS (dB)	COUPLING (dB)	DIRECTIVITY (dB)	RETURN LOSS		
				IN	(dB) OUT	CPL
10.0	3.17	6.45	13.59	10.49	11.97	8.73
30.0	2.92	6.32	16.43	12.58	19.00	11.10
50.0	2.88	6.28	17.00	13.07	21.35	11.67
70.0	2.84	6.25	17.24	13.38	22.26	11.98
90.0	2.82	6.24	17.36	13.64	22.61	12.19
100.0	2.83	6.24	17.37	13.75	22.64	12.26
110.0	2.84	6.23	17.37	13.86	22.63	12.32
120.0	2.83	6.23	17.39	13.96	22.57	12.38
130.0	2.81	6.23	17.38	14.05	22.47	12.42
140.0	2.82	6.23	17.38	14.13	22.36	12.46
150.0	2.83	6.23	17.36	14.19	22.24	12.51
160.0	2.80	6.23	17.33	14.22	22.09	12.55
170.0	2.77	6.23	17.32	14.24	21.94	12.58
180.0	2.78	6.23	17.28	14.24	21.77	12.62
190.0	2.83	6.23	17.26	14.22	21.62	12.65
200.0	2.84	6.23	17.23	14.20	21.46	12.69
250.0	2.77	6.22	17.04	14.07	20.67	12.84
300.0	2.83	6.19	16.84	14.58	19.75	12.85
350.0	2.78	6.18	16.54	15.22	19.02	13.11
400.0	2.85	6.15	16.47	15.58	18.37	13.68
450.0	2.92	6.14	16.12	15.72	17.72	14.14
500.0	2.88	6.10	15.91	16.42	17.08	14.30
550.0	2.94	6.07	15.64	16.88	16.47	14.27
600.0	2.95	6.02	15.39	16.21	15.88	14.06
650.0	3.04	6.00	15.13	15.80	15.32	13.83
700.0	3.07	5.95	14.82	16.31	14.77	13.76
710.0	3.10	5.94	14.76	16.46	14.67	13.80
720.0	3.12	5.94	14.70	16.59	14.58	13.86
730.0	3.13	5.93	14.67	16.68	14.49	13.92
740.0	3.13	5.92	14.65	16.71	14.40	13.99
750.0	3.15	5.92	14.63	16.70	14.32	14.09
760.0	3.17	5.91	14.61	16.64	14.24	14.18
770.0	3.17	5.91	14.54	16.53	14.16	14.28
780.0	3.16	5.91	14.49	16.37	14.09	14.35
790.0	3.18	5.91	14.45	16.20	14.03	14.42
800.0	3.22	5.90	14.40	16.02	13.96	14.44
900.0	3.35	5.83	13.68	15.84	13.27	14.24
1000.0	3.50	5.76	12.96	15.10	12.72	13.87



Directional Coupler

Typical Performance Curves

ADC-ED10553/1

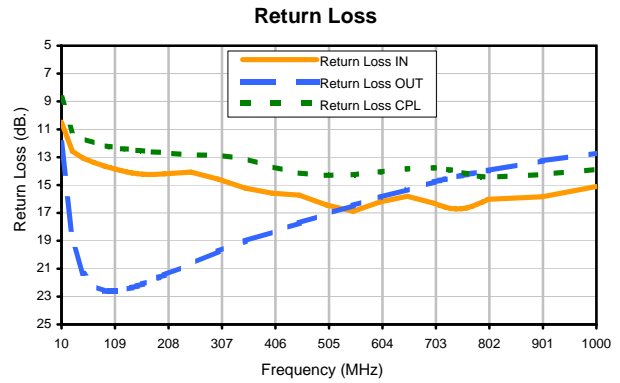
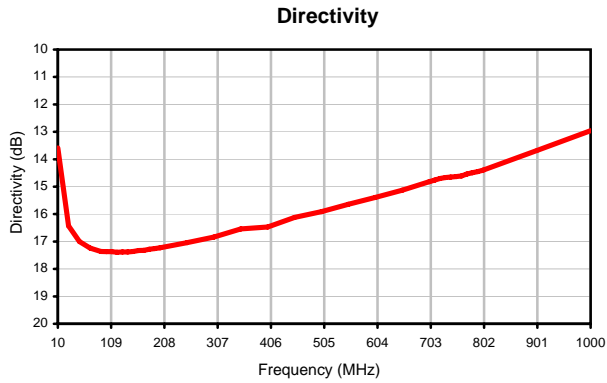
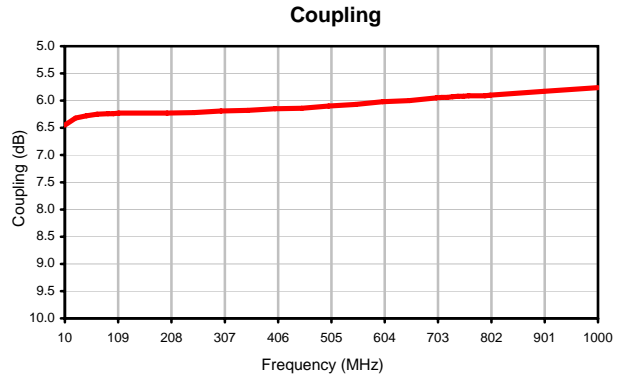
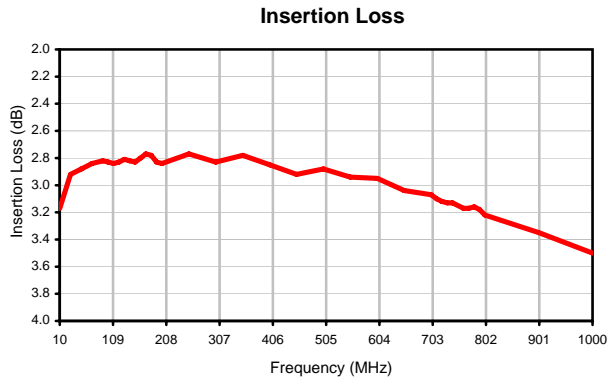

Case Style

CD

CD541
CD542
CD636
CD637

Outline Dimensions



PCB Land Pattern



Suggested Layout,
Tolerance to be within $\pm .002$

CASE#	A	B	C	D	E	F	G	H	J	K	L	WT, GRAM
CD541					.082 (2.08)							.15
CD542	.272 (6.91)	.310 (7.87)	.220 (5.58)	.100 (2.54)	.112 (2.84)	.055 (1.40)	.100 (2.54)	.030 (0.76)	.026 (0.66)	.065 (1.65)	.300 (7.62)	.20
CD636					.162 (4.11)							.25
CD637					.206 (5.23)							.40

Dimensions are in inches (mm). Tolerances: 2 Pl. $\pm .01$; 3 Pl. $\pm .005$

Notes:

- Case material: Plastic.
- Termination finish:
 - For RoHS Case Styles: Tin plate over Nickel plate. All models, (+) suffix.
 - For RoHS-5 Case Styles: Tin-Lead plate. All models, no (+) suffix.

Mini-Circuits

INTERNET <http://www.minicircuits.com>

P.O. Box 350166, Brooklyn, New York 11235-0003 (718) 934-4500 Fax (718) 332-4661

Distribution Centers NORTH AMERICA 800-654-7949 • 417-335-5935 • Fax 417-335-5945 • EUROPE 44-1252-832600 • Fax 44-1252-837010

Mini-Circuits ISO 9001 & ISO 14001 Certified

Tape & Reel Packaging TR-F34



Tape Width, mm	Device Cavity Pitch, mm	Reel Size, inches	Devices per Reel see note	
16	12	7	Small quantity standard (see note)	20
				50
				100
				200
		13	Standard	500
				1000

Note: Availability of small reel quantity varies by model.
Refer to pricing and availability on individual model dashboard.

Mini-Circuits carrier tape materials provide protection from ESD (Electro-Static Discharge) during handling and transportation. Tapes are static dissipative and comply with industry standards EIA-481/EIA-541.

Go to: www.minicircuits.com/pages/pdfs/tape.pdf



INTERNET <http://www.minicircuits.com>

P.O. Box 350166, Brooklyn, New York 11235-0003 (718) 934-4500 Fax (718) 332-4661

Distribution Centers NORTH AMERICA 800-654-7949 • 417-335-5935 • Fax 417-335-5945 • EUROPE 44-1252-832600 • Fax 44-1252-837010

Mini-Circuits ISO 9001 & ISO 14001 Certified

THIRD ANGLE PROJECTION

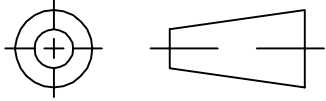

REVISIONS

REV	ECN No.	DESCRIPTION	DATE	DR	AUTH
OR	M82272	NEW RELEASE	08/05/02	MMG	DJ
A	M102713	ADDED NOTE 2 & "...WITH SMOBC"	01/17/06	MMG	IL

SUGGESTED MOUNTING CONFIGURATION
FOR CD542 CASE STYLE "hz" PIN CONNECTION

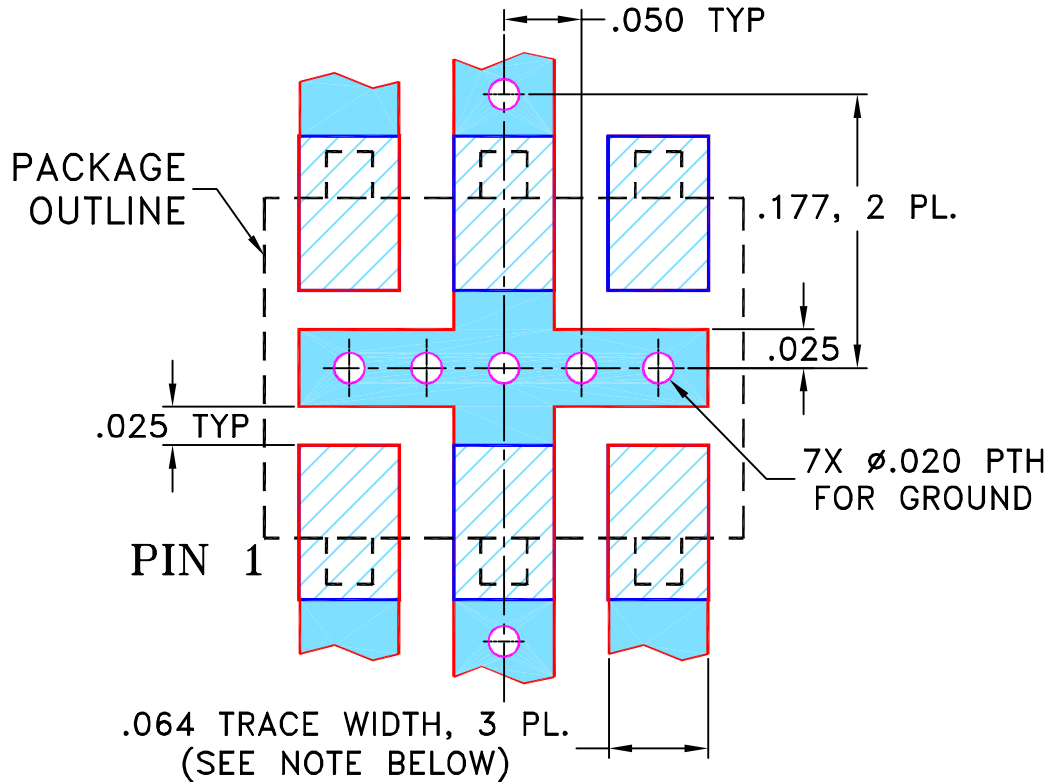

- NOTES: 1. TRACE WIDTH IS SHOWN FOR ROGERS RO4350B WITH DIELECTRIC THICKNESS .030" ± .002"; COPPER: 1/2 OZ. EACH SIDE.
 FOR OTHER MATERIALS TRACE WIDTH MAY NEED TO BE MODIFIED.
 2. BOTTOM SIDE OF THE PCB IS CONTINUOUS GROUND PLANE.

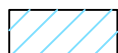
-  DENOTES PCB COPPER LAYOUT WITH SMOBC (SOLDER MASK OVER BARE COPPER)
 DENOTES COPPER LAND PATTERN FREE OF SOLDER MASK

UNLESS OTHERWISE SPECIFIED	INITIALS	DATE
DIMENSIONS ARE IN INCHES	DRAWN MMG	07/23/02
TOLERANCES ON:	CHECKED LC	08/02/02
2 PL DECIMALS ±	APPROVED DJ	08/05/02
3 PL DECIMALS ± .005		
ANGLES ±		
FRACTIONS ±		

 **Mini-Circuits®** 13 Neptune Avenue
 Brooklyn NY 11235

PL, hz, CD542, ADC, TB-32

SIZE A	CODE IDENT 15542	DRAWING NO: 98-PL-094	REV: A
FILE: 98PL094	SCALE: 8:1	SHEET: 1 OF 1	

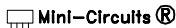
 Mini-Circuits®
 THIS DOCUMENT AND ITS CONTENTS ARE THE PROPERTY OF MINI-CIRCUITS. EXCEPT FOR USE EXPRESSLY GRANTED, IN WRITING, TO ITS VENDORS, VENDEE AND THE UNITED STATES GOVERNMENT, MINI-CIRCUITS RESERVES ALL PROPRIETARY DESIGN, USE, MANUFACTURING AND REPRODUCTION RIGHTS THERETO. THESE CONTENTS SHALL NOT BE USED, DUPLICATED OR DISCLOSED TO ANY OUTSIDE PARTY, IN WHOLE OR IN PART, WITHOUT WRITTEN PERMISSION OF MINI-CIRCUITS.

Evaluation Board and Circuit

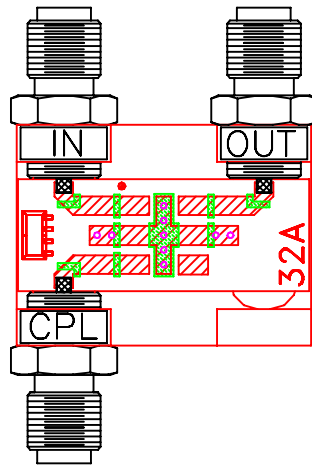

TB-32

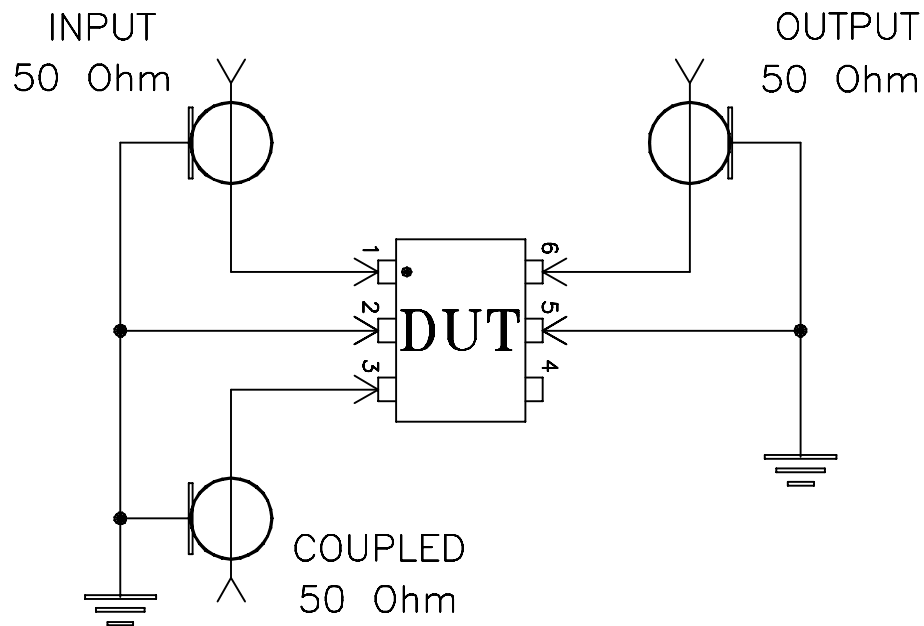

Schematic Diagram

Notes:

1. SMA Female connectors.
2. PCB Material: Rogers R04350 or equivalent,
Dielectric Constant=3.5, Thickness=.030 inch.

 Mini-Circuits®

All Mini-Circuits products are manufactured under exacting quality assurance and control standards, and are capable of meeting published specifications after being subjected to any or all of the following physical and environmental test.

Specification	Test/Inspection Condition	Reference/Spec
Operating Temperature	-40° to 85°C Ambient Environment	Individual Model Data Sheet
Storage Temperature	-55° to 100° C Ambient Environment	Individual Model Data Sheet
Humidity	90 to 95% RH, 240 hours, 50°C	MIL-STD-202, Method 103, Condition A, Except 50°C and end-point electrical test done within 12 hours
Thermal Shock	-55° to 100°C, 100 cycles	MIL-STD-202, Method 107, Condition A-3, except +100°C
Solder Reflow Heat	Sn-Pb Eutetic Process: 225°C peak Pb-Free Process 245° - 250°C peak	J-STD-020, Table 4-1, 4-2 and 5-2, Figure 5-1
Solderability	10X Magnification	J-STD-002, 95% Coverage
Vibration (High Frequency)	20g peak, 10-2000 Hz, 12 times in each of three perpendicular directions (total 36)	MIL-STD-202, Method 204, Condition D
Mechanical Shock	50g, 11 ms, 1/2-sine, 18 shocks: 3 each direction, each of 3 axes	MIL-STD-202, Method 213, Condition A
Marking Resistance to Solvents	Isopropyl alcohol + mineral spirits at 25°C; terpene defluxer at 25°C; distilled water + proylene glycol monomethyl ether + monoethanolamine at 63°C to 70°C	MIL-STD-202, Method 215