

Surface Mount Frequency Mixer

ADE-13+

Level 7 (LO Power +7 dBm) 50 to 1600 MHz



CASE STYLE: CD541

Maximum Ratings

Operating Temperature	-40°C to 85°C
Storage Temperature	-55°C to 100°C
RF Power	50mW
IF Current	40mA

Pin Connections

LO	6
RF	3
IF	4
GROUND	1,2,5

Features

- low conversion loss, 8.1 dB typ.
- excellent L-R isolation, 40 dB typ.
- low profile package
- aqueous washable
- protected by U.S. Patent 6,133,525

Applications

- satellite distribution
- GPS

+RoHS Compliant

The +Suffix identifies RoHS Compliance. See our web site for RoHS Compliance methodologies and qualifications



Available Tape and Reel at no extra cost

Reel Size	Devices/Reel
7"	20, 50, 100, 200, 500
13"	500, 1000

Outline Drawing

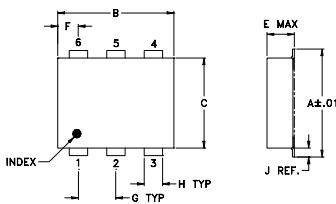

PCB Land Pattern

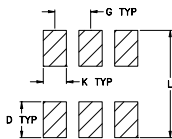

Suggested Layout, Tolerance to be within ±.002

Outline Dimensions (inch/mm)

A	B	C	D	E	F	G
.272	.310	.220	.100	.082	.055	.100
6.91	7.87	5.59	2.54	2.08	1.40	2.54
H	J	K	L	wt		
.030	.026	.065	.300	grams		
0.76	0.66	1.65	7.62	0.15		

Demo Board MCL P/N: TB-02
Suggested PCB Layout (PL-051)

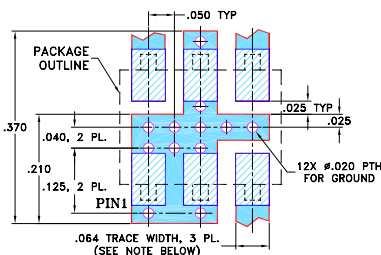

- NOTES: 1. TRACE WIDTH IS SHOWN FOR ROGERS RO4350B WITH DIELECTRIC THICKNESS .030" ± .002"; COPPER: 1/2 OZ. EACH SIDE. FOR OTHER MATERIALS TRACE WIDTH MAY NEED TO BE MODIFIED.
2. BOTTOM SIDE OF THE PCB IS CONTINUOUS GROUND PLANE.

- DENOTES PCB COPPER LAYOUT WITH SMOBC (SOLDER MASK OVER BARE COPPER)
- DENOTES COPPER LAND PATTERN FREE OF SOLDER MASK

Notes

- A. Performance and quality attributes and conditions not expressly stated in this specification document are intended to be excluded and do not form a part of this specification document.
B. Electrical specifications and performance data contained in this specification document are based on Mini-Circuit's applicable established test performance criteria and measurement instructions.
C. The parts covered by this specification document are subject to Mini-Circuit's standard limited warranty and terms and conditions (collectively, "Standard Terms"); Purchasers of this part are entitled to the rights and benefits contained therein. For a full statement of the Standard Terms and the exclusive rights and remedies thereunder, please visit Mini-Circuit's website at www.minicircuits.com/MCLStore/terms.jsp

Electrical Specifications

FREQUENCY (MHz)	CONVERSION LOSS (dB)	LO-RF ISOLATION (dB)			LO-IF ISOLATION (dB)			IP3 at center band (dBm)										
		L	M	U	L	M	U											
LO/RF f_L - f_U	Mid-Band m \bar{X} σ Max.	Typ.	Min.	Typ.	Min.	Typ.	Min.	Typ.										
50-1600	50-1000	8.1	0.10	9.0	9.8	50	25	40	25	33	20	49	30	35	20	32	20	11

1 dB COMP.: +1 dBm typ.

L = low range [f_L to 10 f_L]
m = mid band [$2f_L$ to $f_U/2$]

M = mid range [10 f_L to $f_U/2$]

U = upper range [$f_U/2$ to f_U]

Typical Performance Data

Frequency (MHz)		Conversion Loss (dB)	Isolation L-R (dB)	Isolation L-I (dB)	VSWR RF Port (:1)	VSWR LO Port (:1)
RF	LO	LO +7dBm	LO +7dBm	LO +7dBm	LO +7dBm	LO +7dBm
50.00	80.00	7.46	55.80	52.20	1.07	2.68
100.00	130.00	7.58	52.00	47.90	1.05	2.72
160.71	190.71	7.51	49.30	44.30	1.01	2.61
271.43	301.43	7.74	45.70	40.50	1.13	2.58
300.00	330.00	7.76	45.00	39.70	1.17	2.72
382.14	412.14	7.69	43.20	38.00	1.31	2.65
492.86	522.86	7.86	40.40	36.20	1.49	2.61
500.00	530.00	7.92	40.40	36.10	1.50	2.61
603.57	633.57	8.06	37.80	35.40	1.71	2.46
714.29	744.29	8.16	36.20	34.40	1.81	2.35
825.00	855.00	7.91	35.30	33.50	1.69	2.52
935.71	965.71	7.87	32.30	33.20	1.64	2.72
1000.00	1030.00	7.75	31.00	33.40	1.63	2.80
1046.43	1076.43	7.87	30.60	33.60	1.61	2.80
1157.14	1187.14	8.02	30.00	33.20	1.48	3.01
1267.86	1297.86	8.09	30.60	32.80	1.30	3.26
1300.00	1330.00	8.17	31.50	32.30	1.27	3.32
1378.57	1408.57	8.24	31.60	31.90	1.27	3.57
1489.29	1519.29	8.30	28.10	31.10	1.42	4.22
1600.00	1630.00	8.40	27.60	30.80	1.56	5.33

Electrical Schematic

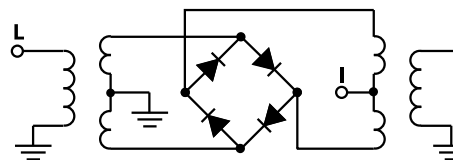

Mini-Circuits

www.minicircuits.com P.O. Box 350166, Brooklyn, NY 11235-0003 (718) 934-4500 sales@minicircuits.com

REV. G
M158496
ADE-13+
ED-6103/1
DJ/TD/CP/AM
161021
Page 1 of 2

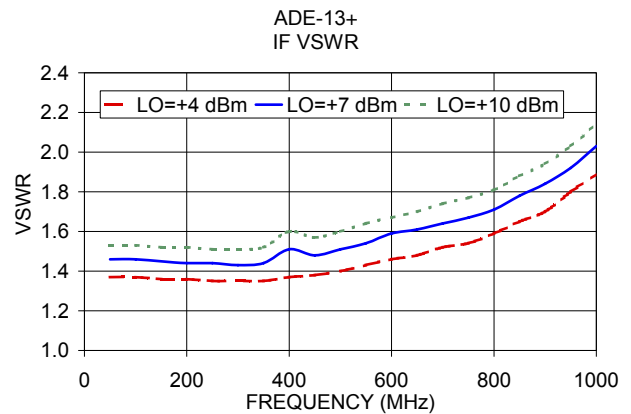
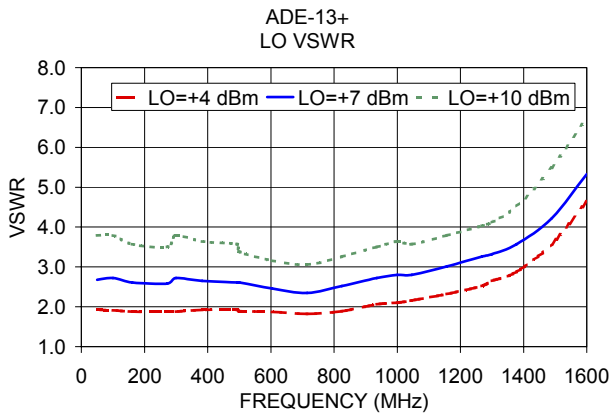
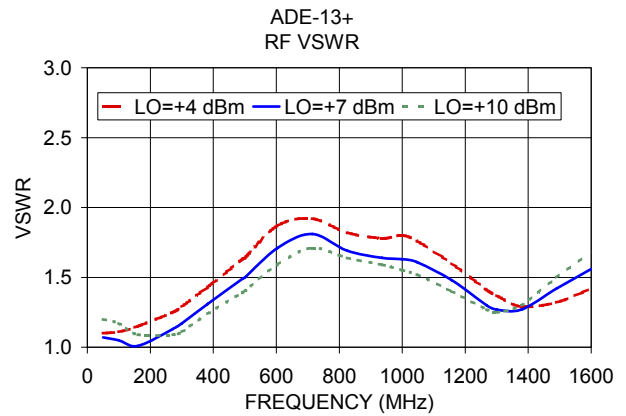
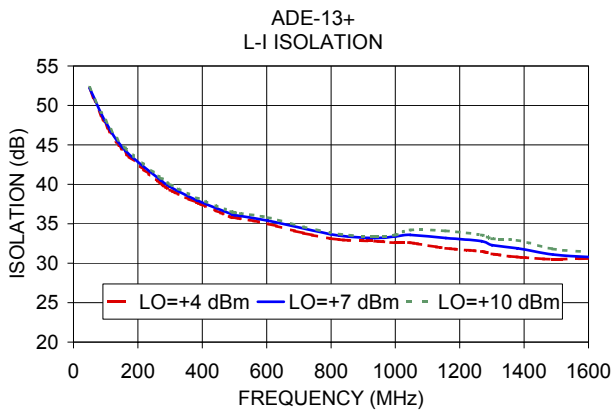
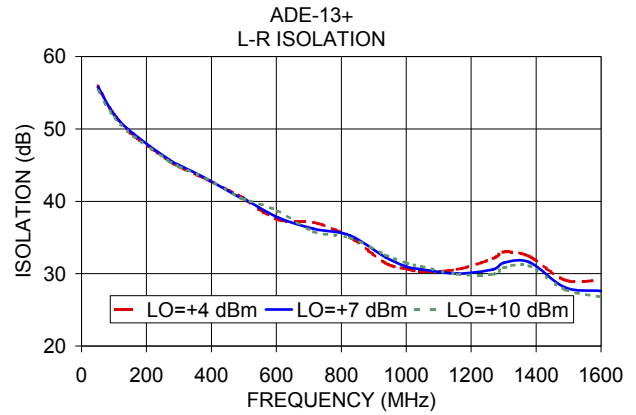
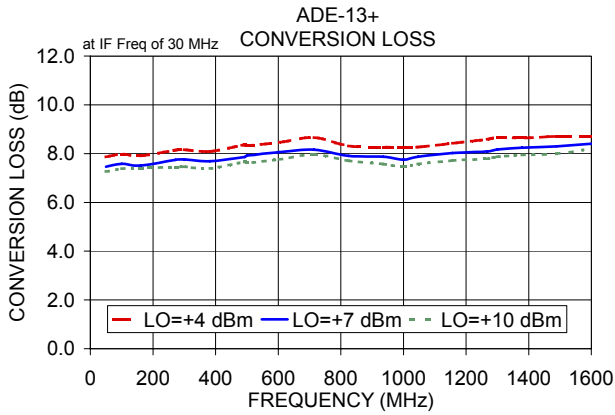

Notes

- A. Performance and quality attributes and conditions not expressly stated in this specification document are intended to be excluded and do not form a part of this specification document.
- B. Electrical specifications and performance data contained in this specification document are based on Mini-Circuit's applicable established test performance criteria and measurement instructions.
- C. The parts covered by this specification document are subject to Mini-Circuit's standard limited warranty and terms and conditions (collectively, "Standard Terms"); Purchasers of this part are entitled to the rights and benefits contained therein. For a full statement of the Standard Terms and the exclusive rights and remedies thereunder, please visit Mini-Circuit's website at www.minicircuits.com/MCLStore/terms.jsp



Typical Performance Data

RF (IN) (MHz)	LO (MHz)	CONVERSION LOSS IF FIXED @IF(OUT)=50MHz (dB)			RF (IN) (MHz)	LO (MHz)	IP3 INPUT (dBm)			RF (IN) (MHz)	LO (MHz)	COMPRESSION @RF IN=+1dBm (dB)		
		@LO (dBm)					@LO (dBm)					@LO (dBm)		
		+4	+7	+10			+4	+7	+10			+4	+7	+10
10.1	60.1	6.99	6.45	6.28	10.1	60.1	12.96	14.60	14.33	10.1	60.1	20.57	16.95	4.37
70.4	120.4	7.83	7.31	7.08	70.4	120.4	11.58	11.86	12.62	70.4	120.4	1.16	0.70	0.43
130.7	180.7	7.78	7.31	7.09	130.7	180.7	10.12	12.39	15.54	130.7	180.7	1.17	0.75	0.54
191.0	241.0	7.84	7.36	7.14	191.0	241.0	10.53	14.51	18.86	191.0	241.0	1.14	0.74	0.48
251.3	301.3	7.88	7.44	7.20	251.3	301.3	11.97	18.67	15.66	251.3	301.3	1.27	0.88	0.58
311.5	361.5	7.92	7.47	7.21	311.5	361.5	14.11	14.42	14.58	311.5	361.5	1.27	0.92	0.72
371.8	421.8	8.01	7.54	7.30	371.8	421.8	14.39	12.91	13.72	371.8	421.8	1.36	0.96	0.73
432.1	482.1	8.05	7.59	7.29	432.1	482.1	12.48	12.13	13.24	432.1	482.1	1.39	1.04	0.85
492.4	542.4	8.16	7.66	7.43	492.4	542.4	9.96	10.90	11.25	492.4	542.4	1.49	1.11	0.83
552.7	602.7	8.21	7.68	7.38	552.7	602.7	8.54	9.82	13.43	552.7	602.7	1.34	1.10	0.86
613.0	663.0	8.37	7.87	7.53	613.0	663.0	8.19	9.08	10.67	613.0	663.0	1.45	1.11	1.04
673.3	723.3	8.45	8.01	7.72	673.3	723.3	7.64	8.35	9.40	673.3	723.3	1.34	1.04	0.86
733.6	783.6	8.36	7.99	7.76	733.6	783.6	7.67	8.68	9.82	733.6	783.6	1.25	0.96	0.79
793.9	843.9	8.29	7.85	7.63	793.9	843.9	7.36	10.43	13.39	793.9	843.9	1.43	1.13	1.06
834.0	884.0	8.25	7.78	7.56	834.0	884.0	7.24	10.11	12.62	834.0	884.0	1.33	1.06	0.96
894.3	944.3	8.26	7.73	7.49	894.3	944.3	7.24	8.77	11.53	894.3	944.3	1.35	1.23	1.05
934.5	984.5	8.35	7.77	7.50	934.5	984.5	7.80	8.35	10.76	934.5	984.5	1.26	1.15	1.00
994.8	1044.8	8.38	7.78	7.45	994.8	1044.8	8.36	8.94	9.68	994.8	1044.8	1.11	1.06	0.93
1035.0	1085.0	8.45	7.85	7.48	1035.0	1085.0	8.19	9.47	9.75	1035.0	1085.0	1.06	0.93	0.87
1095.3	1145.3	8.50	7.93	7.52	1095.3	1145.3	7.78	9.94	11.05	1095.3	1145.3	1.06	0.92	0.89
1135.5	1185.5	8.59	8.03	7.63	1135.5	1185.5	7.09	9.37	12.00	1135.5	1185.5	1.09	0.89	0.89
1195.8	1245.8	8.66	8.19	7.83	1195.8	1245.8	6.07	7.60	10.02	1195.8	1245.8	1.07	0.91	0.88
1236.0	1286.0	8.66	8.27	7.94	1236.0	1286.0	5.30	6.06	7.53	1236.0	1286.0	1.08	0.78	0.74
1296.3	1346.3	8.57	8.21	7.91	1296.3	1346.3	5.16	5.36	6.08	1296.3	1346.3	1.15	0.80	0.75
1336.4	1386.4	8.53	8.12	7.80	1336.4	1386.4	5.47	6.08	7.42	1336.4	1386.4	1.21	0.92	0.82
1396.7	1446.7	8.43	7.95	7.63	1396.7	1446.7	6.90	8.93	11.09	1396.7	1446.7	1.38	0.96	0.69
1436.9	1486.9	8.34	7.83	7.58	1436.9	1486.9	8.57	10.96	12.78	1436.9	1486.9	1.39	0.98	0.66
1497.2	1547.2	8.26	7.78	7.53	1497.2	1547.2	9.11	11.79	13.81	1497.2	1547.2	1.49	0.91	0.58
1537.4	1587.4	8.24	7.77	7.55	1537.4	1587.4	9.04	11.85	14.25	1537.4	1587.4	1.44	0.79	0.52
1597.7	1647.7	8.21	7.82	7.60	1597.7	1647.7	9.41	13.06	14.75	1597.7	1647.7	1.38	0.72	0.44
1637.9	1687.9	8.30	7.89	7.68	1637.9	1687.9	9.29	12.50	14.65	1637.9	1687.9	1.46	0.71	0.48
1698.2	1748.2	8.37	7.99	7.80	1698.2	1748.2	9.31	12.84	14.68	1698.2	1748.2	1.27	0.61	0.35
1738.4	1788.4	8.47	8.09	7.89	1738.4	1788.4	8.77	12.55	14.72	1738.4	1788.4	1.28	0.54	0.34
1798.7	1848.7	8.66	8.24	8.06	1798.7	1848.7	8.23	11.41	13.71	1798.7	1848.7	1.20	0.54	0.29
1838.9	1888.9	8.81	8.40	8.23	1838.9	1888.9	7.95	11.50	13.36	1838.9	1888.9	1.30	0.63	0.29
1899.1	1949.1	9.11	8.65	8.47	1899.1	1949.1	7.58	11.02	14.40	1899.1	1949.1	1.20	0.53	0.30
1939.3	1989.3	9.36	8.86	8.71	1939.3	1989.3	7.46	10.67	13.26	1939.3	1989.3	1.17	0.51	0.31
1999.6	2049.6	9.70	9.18	9.01	1999.6	2049.6	8.53	11.63	14.58	1999.6	2049.6	1.15	0.52	0.23
2039.8	2089.8	10.02	9.48	9.28	2039.8	2089.8	7.66	11.28	12.90	2039.8	2089.8	1.09	0.51	0.21
2100.1	2150.1	10.34	9.81	9.65	2100.1	2150.1	8.65	13.36	14.27	2100.1	2150.1	0.99	0.39	0.25

Frequency Mixer

ADE-13+

Typical Performance Data

IF (OUT) (MHz)	LO (MHz)	CONVERSION LOSS VS. IF FREQUENCY @RF(IN)=800.1MHz (dB)	IF (OUT) (MHz)	LO (MHz)	CONVERSION LOSS VS. IF FREQUENCY @RF(IN)=50.1MHz (dB)	IF (OUT) (MHz)	LO (MHz)	CONVERSION LOSS VS. IF FREQUENCY @RF(IN)=1600.1MHz (dB)
		@LO (dBm)			@LO (dBm)			@LO (dBm)
		+7			+7			+7
790.0	10.1	7.44	50.0	100.1	7.20	1000.0	600.1	7.56
771.0	29.1	7.48	70.2	120.3	7.33	979.8	620.3	7.42
752.1	48.0	7.45	90.4	140.5	7.23	959.6	640.5	7.39
733.1	67.0	7.49	110.6	160.7	7.22	939.4	660.7	7.39
714.1	86.0	7.53	130.9	181.0	7.16	919.1	681.0	7.39
695.1	105.0	7.57	151.1	201.2	7.17	898.9	701.2	7.39
676.2	123.9	7.55	171.3	221.4	7.12	878.7	721.4	7.38
657.2	142.9	7.55	191.5	241.6	7.15	858.5	741.6	7.30
638.2	161.9	7.55	211.7	261.8	7.10	838.3	761.8	7.31
619.2	180.9	7.57	231.9	282.0	7.07	818.1	782.0	7.31
600.3	199.8	7.58	252.1	302.2	7.03	797.9	802.2	7.31
581.3	218.8	7.58	272.3	322.4	7.02	777.7	822.4	7.29
562.3	237.8	7.54	292.6	342.7	7.02	757.4	842.7	7.27
543.3	256.8	7.57	312.8	362.9	6.98	737.2	862.9	7.25
524.4	275.7	7.57	333.0	383.1	6.96	717.0	883.1	7.25
505.4	294.7	7.56	353.2	403.3	6.96	696.8	903.3	7.27
486.4	313.7	7.59	373.4	423.5	6.90	676.6	923.5	7.21
467.4	332.7	7.58	393.6	443.7	6.89	656.4	943.7	7.26
448.5	351.6	7.57	413.8	463.9	7.00	636.2	963.9	7.26
429.5	370.6	7.63	434.0	484.1	7.00	616.0	984.1	7.37
410.5	389.6	7.61	454.3	504.4	6.88	595.7	1004.4	7.46
391.5	408.6	7.60	474.5	524.6	6.90	575.5	1024.6	7.51
372.6	427.5	7.60	494.7	544.8	6.90	555.3	1044.8	7.62
353.6	446.5	7.67	514.9	565.0	6.87	535.1	1065.0	7.72
334.6	465.5	7.65	535.3	605.4	6.85	494.7	1105.4	7.87
315.6	484.5	7.75	555.5	625.6	6.88	474.5	1125.6	7.95
296.7	503.4	7.77	616.0	666.1	6.92	434.0	1166.1	8.03
277.7	522.4	7.77	636.2	686.3	6.89	413.8	1186.3	8.10
258.7	541.4	7.79	676.6	726.7	6.92	373.4	1226.7	8.03
239.7	560.4	7.75	696.8	746.9	6.94	353.2	1246.9	8.00
220.8	579.3	7.83	737.2	787.3	6.94	312.8	1287.3	8.01
201.8	598.3	7.81	757.4	807.5	6.93	292.6	1307.5	8.05
182.8	617.3	7.88	797.9	848.0	6.95	252.1	1348.0	8.07
163.8	636.3	7.86	818.1	868.2	6.93	231.9	1368.2	8.09
144.9	655.2	7.90	858.5	908.6	6.95	191.5	1408.6	8.06
125.9	674.2	7.94	878.7	928.8	6.97	171.3	1428.8	7.99
106.9	693.2	7.94	919.1	969.2	7.02	130.9	1469.2	7.91
87.9	712.2	8.01	939.4	989.5	7.12	110.6	1489.5	7.91
69.0	731.1	7.95	979.8	1029.9	7.22	70.2	1529.9	7.81
50.0	750.1	7.95	1000.0	1050.1	7.28	50.0	1550.1	7.80

REV. X2
ADE-13+
100817
Page 2 of 5



IF/RF MICROWAVE COMPONENTS • ISO 9001 ISO 14001 AS 9100 CERTIFIED • RoHS compliant
P.O. Box 350166, Brooklyn, New York 11235-0003 (718) 934-4500 Fax (718) 332-4661



The Design Engineers Search Engine finds the model you need, Instantly • For detailed performance specs & shopping online see



Typical Performance Data

LO (MHz)	LO-RF ISOLATION (dB)			LO-IF ISOLATION (dB)		
	@LO (dBm)			@LO (dBm)		
	+4	+7	+10	+4	+7	+10
10.1	58.40	53.85	54.17	57.27	57.85	67.92
70.4	52.12	49.64	48.36	52.89	52.37	53.05
130.7	47.33	45.42	44.30	47.21	47.33	47.37
191.0	44.65	42.99	42.07	43.93	44.13	44.26
251.3	42.83	41.47	40.50	41.70	41.90	41.95
311.5	41.55	40.22	39.17	40.05	40.24	40.32
371.8	40.45	39.07	38.05	38.70	38.83	38.90
432.1	39.37	38.20	37.21	37.60	37.75	37.81
492.4	37.63	36.68	35.93	36.84	37.08	37.19
552.7	35.74	35.08	34.46	35.92	36.13	36.24
613.0	34.23	33.78	33.49	35.36	35.51	35.54
673.3	33.16	32.51	32.09	35.04	35.26	35.32
733.6	32.00	31.51	31.03	34.67	34.87	34.96
793.9	31.12	30.86	30.41	34.51	34.56	34.54
834.0	30.56	30.66	30.34	34.51	34.45	34.34
894.3	29.17	29.63	29.73	34.78	34.74	34.59
934.5	28.44	28.79	28.98	34.94	34.92	34.70
994.8	27.56	27.75	27.93	34.99	35.08	34.83
1035.0	27.31	27.52	27.72	34.97	35.05	34.82
1095.3	26.61	26.88	27.13	35.02	35.15	34.99
1135.5	26.18	26.44	26.69	35.10	35.23	35.13
1195.8	25.86	26.10	26.32	35.68	35.80	35.74
1236.0	25.68	25.88	25.98	35.93	36.06	35.94
1296.3	26.04	26.53	26.76	36.52	36.58	36.40
1336.4	26.09	26.88	27.35	36.85	36.83	36.65
1396.7	25.83	26.89	27.71	36.83	37.03	37.07
1436.9	25.59	26.70	27.61	36.77	37.40	37.86
1497.2	24.92	26.01	27.02	36.69	38.32	39.68
1537.4	24.64	25.76	26.82	36.43	38.61	40.53
1597.7	24.35	25.49	26.62	35.96	38.70	41.38
1637.9	24.33	25.47	26.62	35.52	38.33	41.24
1698.2	24.63	25.75	26.88	35.08	37.77	40.66
1738.4	24.96	26.01	27.09	34.63	37.12	39.69
1798.7	25.73	26.55	27.41	34.15	36.23	38.26
1838.9	26.33	26.87	27.45	33.66	35.37	36.95
1899.1	27.49	27.48	27.55	33.10	34.27	35.22
1939.3	28.38	27.87	27.50	32.86	33.65	34.20
1999.6	30.05	28.46	27.40	32.22	32.48	32.57
2039.8	30.86	28.57	27.14	31.72	31.60	31.41
2100.1	31.54	28.52	26.70	31.02	30.52	30.13

RF (IN) (MHz)	LO (MHz)	RF-IF ISOLATION (dB)		
		@LO (dBm)		
		+4	+7	+10
10.1	60.1	40.57	32.81	35.25
70.4	120.4	38.58	41.02	39.90
130.7	180.7	34.36	35.50	36.15
191.0	241.0	31.54	32.17	32.68
251.3	301.3	29.41	30.16	30.75
311.5	361.5	27.86	28.48	29.03
371.8	421.8	26.62	27.32	28.05
432.1	482.1	25.64	26.57	27.29
492.4	542.4	25.08	25.88	26.60
552.7	602.7	24.92	25.85	26.64
613.0	663.0	25.07	26.14	27.18
673.3	723.3	25.42	26.66	27.69
733.6	783.6	25.83	27.31	28.43
793.9	843.9	25.72	27.25	28.20
834.0	884.0	25.05	26.33	26.80
894.3	944.3	23.83	24.60	24.83
934.5	984.5	23.35	23.98	24.21
994.8	1044.8	22.97	23.35	23.51
1035.0	1085.0	23.05	23.38	23.39
1095.3	1145.3	23.84	23.95	23.74
1135.5	1185.5	24.65	24.67	24.27
1195.8	1245.8	26.33	26.00	25.23
1236.0	1286.0	26.91	26.41	25.52
1296.3	1346.3	25.00	24.10	23.09
1336.4	1386.4	22.83	21.77	20.74
1396.7	1446.7	19.86	18.76	17.94
1436.9	1486.9	18.06	17.10	16.45
1497.2	1547.2	15.92	15.13	14.64
1537.4	1587.4	14.72	14.01	13.58
1597.7	1647.7	13.16	12.47	12.07
1637.9	1687.9	12.38	11.64	11.22
1698.2	1748.2	11.27	10.52	10.08
1738.4	1788.4	10.67	9.87	9.41
1798.7	1848.7	9.79	8.94	8.47
1838.9	1888.9	9.25	8.38	7.89
1899.1	1949.1	8.56	7.64	7.14
1939.3	1989.3	8.15	7.21	6.70
1999.6	2049.6	7.57	6.60	6.07
2039.8	2089.8	7.32	6.33	5.79
2100.1	2150.1	6.71	5.81	5.31

Typical Performance Data

RF (IN) (MHz)	LO (MHz)	RF VSWR (:1)		
		@LO (dBm)		
		+4	+7	+10
10.1	60.1	1.33	1.26	1.20
70.4	120.4	1.19	1.03	1.14
130.7	180.7	1.20	1.03	1.08
191.0	241.0	1.25	1.09	1.02
251.3	301.3	1.28	1.14	1.07
311.5	361.5	1.32	1.18	1.11
371.8	421.8	1.41	1.27	1.19
432.1	482.1	1.50	1.36	1.27
492.4	542.4	1.58	1.44	1.37
552.7	602.7	1.66	1.50	1.40
613.0	663.0	1.77	1.62	1.51
673.3	723.3	1.84	1.72	1.63
733.6	783.6	1.85	1.75	1.69
793.9	843.9	1.84	1.73	1.68
834.0	884.0	1.88	1.78	1.75
894.3	944.3	1.88	1.78	1.77
934.5	984.5	1.96	1.82	1.81
994.8	1044.8	1.99	1.82	1.79
1035.0	1085.0	2.02	1.84	1.76
1095.3	1145.3	2.04	1.88	1.77
1135.5	1185.5	2.13	1.97	1.85
1195.8	1245.8	2.04	1.93	1.82
1236.0	1286.0	2.03	1.94	1.85
1296.3	1346.3	1.93	1.84	1.77
1336.4	1386.4	1.88	1.77	1.71
1396.7	1446.7	1.75	1.64	1.61
1436.9	1486.9	1.66	1.57	1.56
1497.2	1547.2	1.54	1.48	1.48
1537.4	1587.4	1.47	1.42	1.43
1597.7	1647.7	1.38	1.35	1.37
1637.9	1687.9	1.32	1.29	1.32
1698.2	1748.2	1.23	1.22	1.27
1738.4	1788.4	1.18	1.18	1.24
1798.7	1848.7	1.19	1.04	1.11
1838.9	1888.9	1.08	1.12	1.24
1899.1	1949.1	1.12	1.13	1.24
1939.3	1989.3	1.08	1.17	1.30
1999.6	2049.6	1.16	1.28	1.41
2039.8	2089.8	1.16	1.26	1.39
2100.1	2150.1	1.24	1.40	1.54

LO (MHz)	LO VSWR (:1)		
	@LO (dBm)		
	+4	+7	+10
10.1	1.80	2.37	3.52
70.4	1.83	2.60	3.59
130.7	1.82	2.58	3.55
191.0	1.83	2.57	3.51
251.3	1.84	2.57	3.51
311.5	1.85	2.58	3.51
371.8	1.90	2.66	3.60
432.1	1.90	2.63	3.55
492.4	1.92	2.65	3.54
552.7	1.99	2.74	3.67
613.0	2.00	2.72	3.58
673.3	2.03	2.74	3.59
733.6	2.12	2.85	3.73
793.9	2.12	2.80	3.62
834.0	2.19	2.88	3.70
894.3	2.20	2.83	3.59
934.5	2.31	2.97	3.75
994.8	2.34	2.98	3.72
1035.0	2.41	3.07	3.82
1095.3	2.44	3.10	3.85
1135.5	2.48	3.14	3.89
1195.8	2.52	3.17	3.90
1236.0	2.56	3.20	3.94
1296.3	2.55	3.13	3.82
1336.4	2.57	3.15	3.84
1396.7	2.51	3.01	3.66
1436.9	2.53	3.03	3.70
1497.2	2.50	2.98	3.63
1537.4	2.57	3.06	3.71
1597.7	2.69	3.14	3.76
1637.9	2.82	3.24	3.85
1698.2	2.99	3.35	3.92
1738.4	3.15	3.47	4.02
1798.7	3.33	3.58	4.07
1838.9	3.52	3.72	4.20
1899.1	3.72	3.82	4.22
1939.3	3.92	3.98	4.37
1999.6	4.15	4.08	4.37
2039.8	4.38	4.27	4.55
2100.1	4.57	4.37	4.59

IF (OUT) (MHz)	IF VSWR @LO=1600.1MHz (:1)		
	@LO (dBm)		
	+4	+7	+10
50.1	1.35	1.44	1.50
69.9	1.41	1.50	1.53
89.7	1.36	1.43	1.49
109.5	1.32	1.40	1.45
129.3	1.35	1.39	1.48
149.1	1.35	1.43	1.49
168.9	1.37	1.45	1.49
188.6	1.35	1.42	1.46
208.4	1.32	1.41	1.45
228.2	1.34	1.41	1.46
248.0	1.35	1.42	1.47
267.8	1.34	1.41	1.47
287.6	1.31	1.38	1.44
307.4	1.31	1.37	1.42
327.2	1.31	1.38	1.43
347.0	1.33	1.39	1.44
366.8	1.32	1.39	1.44
386.6	1.31	1.39	1.43
406.4	1.30	1.37	1.42
426.1	1.31	1.39	1.43
445.9	1.30	1.38	1.43
465.7	1.29	1.36	1.42
505.3	1.27	1.35	1.40
525.1	1.27	1.35	1.40
564.7	1.26	1.33	1.39
584.5	1.25	1.33	1.39
624.1	1.25	1.32	1.39
643.9	1.26	1.33	1.40
683.4	1.26	1.34	1.40
703.2	1.27	1.34	1.41
742.8	1.32	1.39	1.45
762.6	1.36	1.42	1.47
802.2	1.38	1.44	1.49
822.0	1.42	1.48	1.53
861.6	1.52	1.57	1.61
881.4	1.55	1.59	1.63
920.9	1.64	1.68	1.71
940.7	1.72	1.75	1.78
980.3	1.83	1.84	1.87
1000.1	1.89	1.89	1.91

Harmonics Tables

RF HARMONICS ORDER

	(-dBm)	(-dBc)										
0	-	-	5	10	26	42	8	24	23	49	34	44
1	-	19	0	31	18	22	37	26	38	42	48	48
2	104	46	57	56	57	45	46	63	39	52	53	58
3	119	52	55	59	56	66	57	55	71	59	60	82
4	119	94	71	67	78	69	82	73	71	86	64	75
5	117	84	94	87	98	88	86	86	91	93	90	85
6	120	104	89	101	91	87	89	83	94	97	93	97
7	109	103	102	104	97	99	104	104	92	95	101	112
8	111	107	102	107	118	102	107	101	96	85	97	99
9	119	92	101	102	100	104	98	105	105	94	95	108
10	112	105	104	99	102	104	107	98	98	100	92	88
	RF CAL	0	1	2	3	4	5	6	7	8	9	10

LO HARMONICS ORDER

Test conditions: RF IN: 820.1 MHz; -14.00 dBm.
 LO IN: 850.1 MHz; +7.00 dBm
 IF OUT: 30 MHz; -22.4 dBm

RF HARMONICS ORDER

	(-dBm)	(-dBc)										
0	-	-	15	19	40	49	22	37	42	59	48	60
1	-	18	0	32	17	26	39	30	41	49	60	67
2	89	44	50	59	49	43	42	57	35	49	48	64
3	110	35	38	44	42	55	46	39	66	45	57	63
4	112	69	66	59	66	56	87	55	56	85	49	64
5	116	60	80	58	57	62	53	67	55	55	70	57
6	114	70	70	85	68	64	69	65	74	72	64	75
7	120	83	82	70	85	70	69	74	65	77	71	67
8	112	86	84	76	77	94	75	72	77	74	76	86
9	112	92	97	91	91	80	94	82	82	81	79	81
10	117	97	92	95	92	85	86	107	86	77	87	78
	RF CAL	0	1	2	3	4	5	6	7	8	9	10

LO HARMONICS ORDER

Test conditions: RF IN: 820.1 MHz; -4.00 dBm.
 LO IN: 850.1 MHz; +7.00 dBm
 IF OUT: 30 MHz; -12.4 dBm

- Notes: 1. All Harmonics are in (dBc) relative to IF OUTPUT.
 2. + entry denotes harmonics are in (dBc) above IF OUTPUT.
 3. RF Cal represent the Harmonics level of the RF input signal to the mixer.

REV. X2
 ADE-13+
 100817

Page 5 of 5



IF/RF MICROWAVE COMPONENTS • ISO 9001 ISO 14001 AS 9100 CERTIFIED • RoHS compliant
 P.O. Box 350166, Brooklyn, New York 11235-0003 (718) 934-4500 Fax (718) 332-4661



The Design Engineers Search Engine finds the model you need, Instantly • For detailed performance specs & shopping online see minicircuits.com

Typical Performance Curves

Conversion Loss @ IF=50MHz

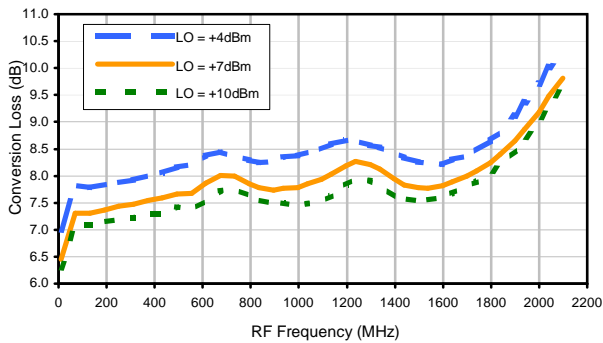

Conversion Loss vs. IF @ RF=800.1MHz

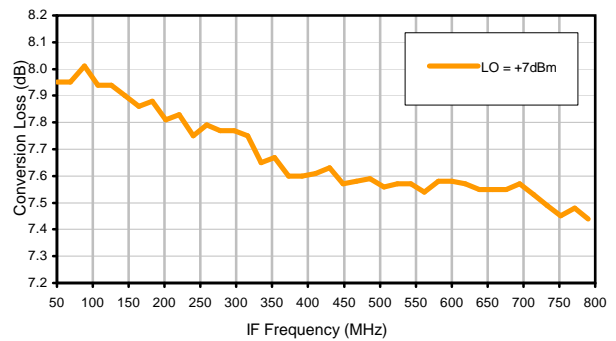

Conversion Loss vs. IF @ RF=50.1MHz

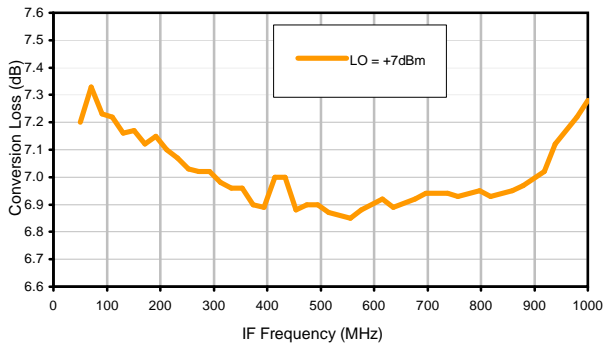

Conversion Loss vs. IF @ RF=1600.1MHz

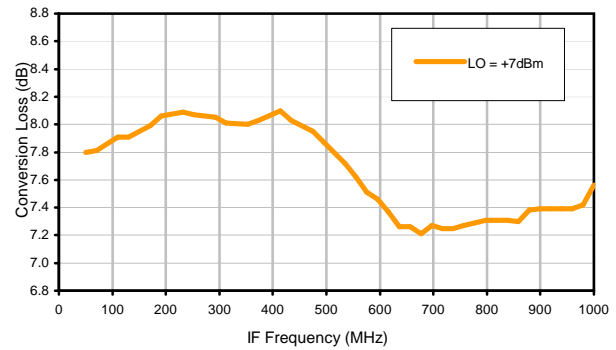

IP3 Input

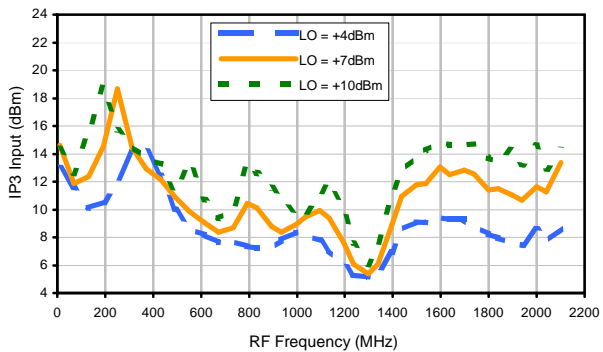

Compression @ RF IN=+1dBm

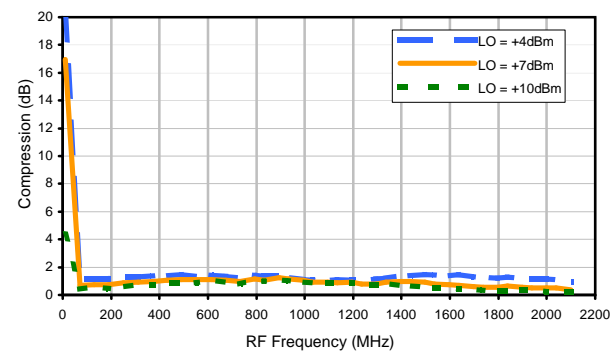

Typical Performance Curves

LO-RF Isolation

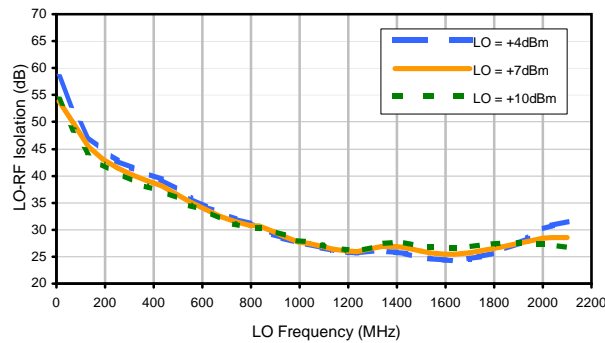

LO-IF Isolation

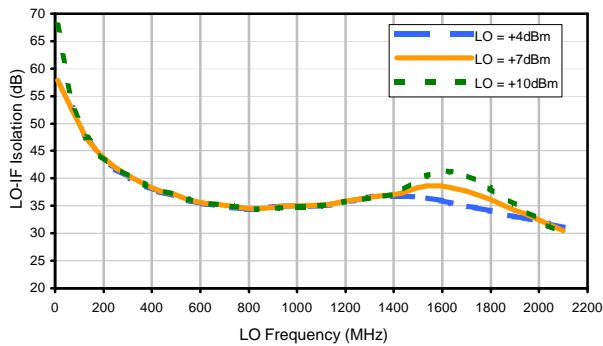

RF-IF Isolation

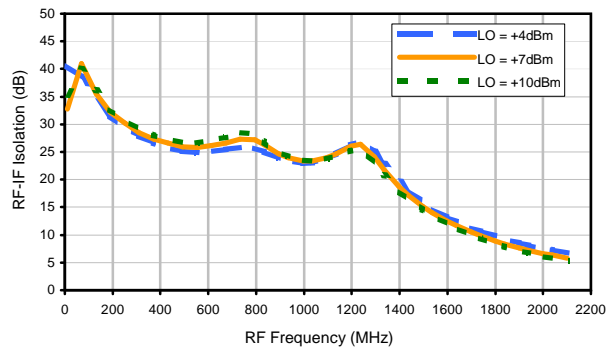

RF VSWR

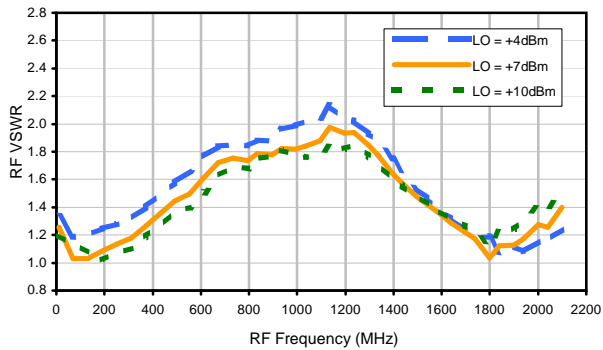

LO VSWR

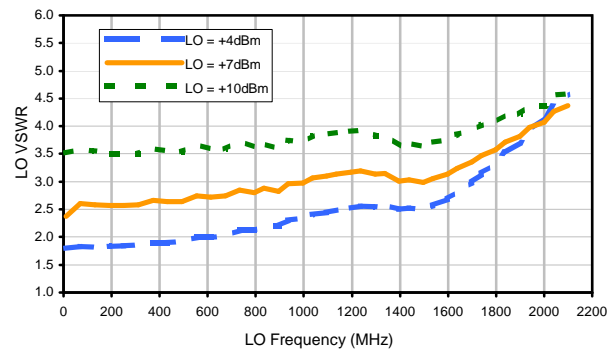

IF VSWR

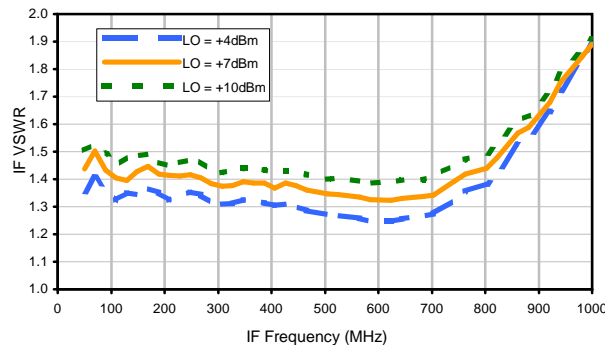

Harmonics Tables

RF HARMONICS ORDER

	(-dBm)	(-dBc)										
0	-	-	5	10	26	42	8	24	23	49	34	44
1	-	19	0	31	18	22	37	26	38	42	48	48
2	104	46	57	56	57	45	46	63	39	52	53	58
3	119	52	55	59	56	66	57	55	71	59	60	82
4	119	94	71	67	78	69	82	73	71	86	64	75
5	117	84	94	87	98	88	86	86	91	93	90	85
6	120	104	89	101	91	87	89	83	94	97	93	97
7	109	103	102	104	97	99	104	104	92	95	101	112
8	111	107	102	107	118	102	107	101	96	85	97	99
9	119	92	101	102	100	104	98	105	105	94	95	108
10	112	105	104	99	102	104	107	98	98	100	92	88
	RF CAL	0	1	2	3	4	5	6	7	8	9	10

LO HARMONICS ORDER

Test conditions: RF IN: 820.1 MHz; -14.00 dBm.
 LO IN: 850.1 MHz; +7.00 dBm
 IF OUT: 30 MHz; -22.4 dBm

RF HARMONICS ORDER

	(-dBm)	(-dBc)										
0	-	-	15	19	40	49	22	37	42	59	48	60
1	-	18	0	32	17	26	39	30	41	49	60	67
2	89	44	50	59	49	43	42	57	35	49	48	64
3	110	35	38	44	42	55	46	39	66	45	57	63
4	112	69	66	59	66	56	87	55	56	85	49	64
5	116	60	80	58	57	62	53	67	55	55	70	57
6	114	70	70	85	68	64	69	65	74	72	64	75
7	120	83	82	70	85	70	69	74	65	77	71	67
8	112	86	84	76	77	94	75	72	77	74	76	86
9	112	92	97	91	91	80	94	82	82	81	79	81
10	117	97	92	95	92	85	86	107	86	77	87	78
	RF CAL	0	1	2	3	4	5	6	7	8	9	10

LO HARMONICS ORDER

Test conditions: RF IN: 820.1 MHz; -4.00 dBm.
 LO IN: 850.1 MHz; +7.00 dBm
 IF OUT: 30 MHz; -12.4 dBm

- Notes: 1. All Harmonics are in (dBc) relative to IF OUTPUT.
 2. + entry denotes harmonics are in (dBc) above IF OUTPUT.
 3. RF Cal represent the Harmonics level of the RF input signal to the mixer.

REV. X2
 ADE-13+
 100817

Page 3 of 3



IF/RF MICROWAVE COMPONENTS • ISO 9001 ISO 14001 AS 9100 CERTIFIED • RoHS compliant
 P.O. Box 350166, Brooklyn, New York 11235-0003 (718) 934-4500 Fax (718) 332-4661



The Design Engineers Search Engine finds the model you need, Instantly • For detailed performance specs & shopping online see minicircuits.com

Case Style

CD

CD541
CD542
CD636
CD637

Outline Dimensions



PCB Land Pattern



Suggested Layout,
Tolerance to be within $\pm .002$

CASE#	A	B	C	D	E	F	G	H	J	K	L	WT, GRAM
CD541					.082 (2.08)							.15
CD542	.272 (6.91)	.310 (7.87)	.220 (5.58)	.100 (2.54)	.112 (2.84)	.055 (1.40)	.100 (2.54)	.030 (0.76)	.026 (0.66)	.065 (1.65)	.300 (7.62)	.20
CD636					.162 (4.11)							.25
CD637					.206 (5.23)							.40

Dimensions are in inches (mm). Tolerances: 2 Pl. $\pm .01$; 3 Pl. $\pm .005$

Notes:

- Case material: Plastic.
- Termination finish:
 - For RoHS Case Styles: Tin plate over Nickel plate. All models, (+) suffix.
 - For RoHS-5 Case Styles: Tin-Lead plate. All models, no (+) suffix.

Mini-Circuits[®]

INTERNET <http://www.minicircuits.com>

P.O. Box 350166, Brooklyn, New York 11235-0003 (718) 934-4500 Fax (718) 332-4661

Distribution Centers NORTH AMERICA 800-654-7949 • 417-335-5935 • Fax 417-335-5945 • EUROPE 44-1252-832600 • Fax 44-1252-837010

Mini-Circuits ISO 9001 & ISO 14001 Certified

Tape & Reel Packaging TR-F34



Tape Width, mm	Device Cavity Pitch, mm	Reel Size, inches	Devices per Reel see note	
16	12	7	Small quantity standard (see note)	20
				50
				100
				200
		13	Standard	500
1000				

Note: Availability of small reel quantity varies by model.
Refer to pricing and availability on individual model dashboard.

Mini-Circuits carrier tape materials provide protection from ESD (Electro-Static Discharge) during handling and transportation. Tapes are static dissipative and comply with industry standards EIA-481/EIA-541.

Go to: www.minicircuits.com/pages/pdfs/tape.pdf



INTERNET <http://www.minicircuits.com>

P.O. Box 350166, Brooklyn, New York 11235-0003 (718) 934-4500 Fax (718) 332-4661

Distribution Centers NORTH AMERICA 800-654-7949 • 417-335-5935 • Fax 417-335-5945 • EUROPE 44-1252-832600 • Fax 44-1252-837010

Mini-Circuits ISO 9001 & ISO 14001 Certified

THIRD ANGLE PROJECTION





REVISIONS

REV	ECN No.	DESCRIPTION	DATE	DR	AUTH
OR	M82272	NEW RELEASE	08/05/02	MMG	DJ
A	M102713	ADDED NOTE 2 & "...WITH SMOBC"	01/17/06	MMG	IL

**SUGGESTED MOUNTING CONFIGURATION
FOR CD541/542/636/637 CASE STYLES,
"jv", "ju", "jw" PIN CONNECTIONS**

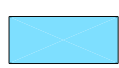

- NOTES:** 1. TRACE WIDTH IS SHOWN FOR ROGERS R04350B WITH DIELECTRIC THICKNESS .030" ± .002"; COPPER: 1/2 OZ. EACH SIDE. FOR OTHER MATERIALS TRACE WIDTH MAY NEED TO BE MODIFIED.
2. BOTTOM SIDE OF THE PCB IS CONTINUOUS GROUND PLANE.

-  DENOTES PCB COPPER LAYOUT WITH SMOBC (SOLDER MASK OVER BARE COPPER)
 DENOTES COPPER LAND PATTERN FREE OF SOLDER MASK

UNLESS OTHERWISE SPECIFIED

DIMENSIONS ARE IN INCHES
TOLERANCES ON:
2 PL DECIMALS ±
3 PL DECIMALS ± .005
ANGLES ±
FRACTIONS ±

	INITIALS	DATE
DRAWN	MMG	07/17/02
CHECKED	WL	08/02/02
APPROVED	DJ	08/05/02



Mini-Circuits®

13 Neptune Avenue
Brooklyn NY 11235

PL, jv/ju/jw, CD541/542/636/637, ADE, TB-02

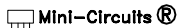
 Mini-Circuits®
THIS DOCUMENT AND ITS CONTENTS ARE THE PROPERTY OF MINI-CIRCUITS. EXCEPT FOR USE EXPRESSLY GRANTED, IN WRITING, TO ITS VENDORS, VENDEE AND THE UNITED STATES GOVERNMENT, MINI-CIRCUITS RESERVES ALL PROPRIETARY DESIGN, USE, MANUFACTURING AND REPRODUCTION RIGHTS THERETO. THESE CONTENTS SHALL NOT BE USED, DUPLICATED OR DISCLOSED TO ANY OUTSIDE PARTY, IN WHOLE OR IN PART, WITHOUT WRITTEN PERMISSION OF MINI-CIRCUITS.

ASHEETA1.DWG REV:A DATE:01/12/95

SIZE	CODE IDENT	DRAWING NO:	REV:
A	15542	98-PL-051	A
FILE:	98PL051	SCALE: 8:1	SHEET: 1 OF 1

Evaluation Board and Circuit

For Pin Connections refer to Data Sheet of the DUT

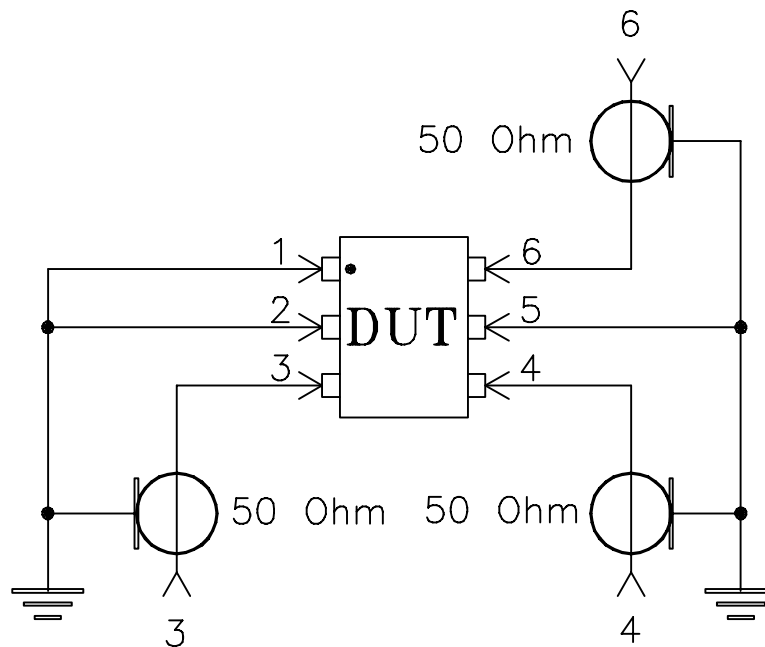

Schematic Diagram

Notes:

1. SMA Female connectors.
2. PCB Material: Rogers R04350 or equivalent,
Dielectric Constant=3.5, Thickness=.030 inch.

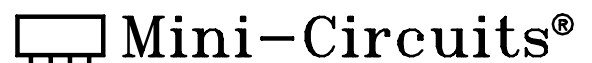



All Mini-Circuits products are manufactured under exacting quality assurance and control standards, and are capable of meeting published specifications after being subjected to any or all of the following physical and environmental test.

Specification	Test/Inspection Condition	Reference/Spec
Operating Temperature	-40° to 85°C Ambient Environment	Individual Model Data Sheet
Storage Temperature	-55° to 100° C Ambient Environment	Individual Model Data Sheet
Humidity	90 to 95% RH, 240 hours, 50°C	MIL-STD-202, Method 103, Condition A, Except 50°C and end-point electrical test done within 12 hours
Thermal Shock	-55° to 100°C, 100 cycles	MIL-STD-202, Method 107, Condition A-3, except +100°C
Solder Reflow Heat	Sn-Pb Eutetic Process: 225°C peak Pb-Free Process 245° - 250°C peak	J-STD-020, Table 4-1, 4-2 and 5-2, Figure 5-1
Solderability	10X Magnification	J-STD-002, 95% Coverage
Vibration (High Frequency)	20g peak, 10-2000 Hz, 12 times in each of three perpendicular directions (total 36)	MIL-STD-202, Method 204, Condition D
Mechanical Shock	50g, 11 ms, 1/2-sine, 18 shocks: 3 each direction, each of 3 axes	MIL-STD-202, Method 213, Condition A
Marking Resistance to Solvents	Isopropyl alcohol + mineral spirits at 25°C; terpene defluxer at 25°C; distilled water + proylene glycol monomethyl ether + monoethanolamine at 63°C to 70°C	MIL-STD-202, Method 215