

Frequency Mixer

ADE-1MH+

Level 13 (LO Power +13 dBm) 2 to 500 MHz

Maximum Ratings

Operating Temperature	-40°C to 85°C
Storage Temperature	-55°C to 100°C
RF Power	200mW
IF Current	40mA
Permanent damage may occur if any of these limits are exceeded.	

Pin Connections

LO	6
RF	3
IF	2
GROUND	1,4,5

Outline Drawing

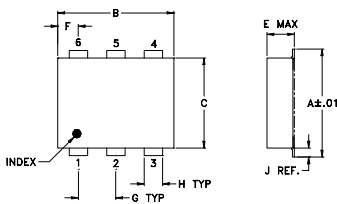

PCB Land Pattern

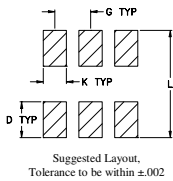

Outline Dimensions (inch/mm)

A	B	C	D	E	F	G
.272	.310	.220	.100	.112	.055	.100
6.91	7.87	5.59	2.54	2.84	1.40	2.54
H	J	K	L	wt		
.030	.026	.065	.300	grams		
0.76	0.66	1.65	7.62	0.20		

Demo Board MCL P/N: TB-03 Suggested PCB Layout (PL-052)

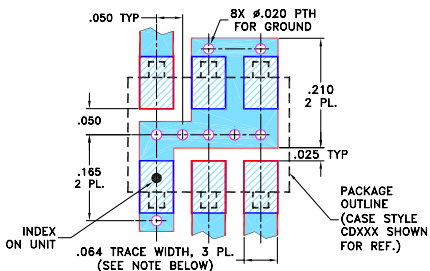

- NOTES:**
- TRACE WIDTH IS SHOWN FOR ROGERS RO4350B WITH DIELECTRIC THICKNESS .030" ± .002"; COPPER: 1/2 OZ. EACH SIDE. FOR OTHER MATERIALS TRACE WIDTH MAY NEED TO BE MODIFIED.
 - BOTTOM SIDE OF THE PCB IS CONTINUOUS GROUND PLANE.
- DENOTES PCB COPPER LAYOUT WITH SMOBC (SOLDER MASK OVER BARE COPPER)
 - DENOTES COPPER LAND PATTERN FREE OF SOLDER MASK

Notes

- A. Performance and quality attributes and conditions not expressly stated in this specification document are intended to be excluded and do not form a part of this specification document.
 B. Electrical specifications and performance data contained in this specification document are based on Mini-Circuit's applicable established test performance criteria and measurement instructions.
 C. The parts covered by this specification document are subject to Mini-Circuits standard limited warranty and terms and conditions (collectively, "Standard Terms"); Purchasers of this part are entitled to the rights and benefits contained therein. For a full statement of the Standard Terms and the exclusive rights and remedies thereunder, please visit Mini-Circuits' website at www.minicircuits.com/MCLStore/terms.jsp

Features

- good L-R isolation, 50 dB typ.
L-I isolation, 45 dB typ.
- low profile package
- aqueous washable
- protected by U.S. Patent 6,133,525

Applications

- cellular
- VHF/UHF receivers



Generic photo used for illustration purposes only
 CASE STYLE: CD542

+RoHS Compliant

The +Suffix identifies RoHS Compliance. See our web site for RoHS Compliance methodologies and qualifications



Available Tape and Reel at no extra cost

Reel Size	Devices/Reel
7"	20, 50, 100, 200
13"	500, 1000

Electrical Specifications

FREQUENCY (MHz)	CONVERSION LOSS (dB)	LO-RF ISOLATION (dB)			LO-IF ISOLATION (dB)			IP3 at center band (dBm)						
		L	M	U	L	M	U							
2-500	DC-500	60	45	50	35	48	25	55	40	45	30	40	22	17

1 dB COMP.: +9 dBm typ.

L = low range [f_L to $10 f_L$] M = mid range [$10 f_L$ to $f_U/2$] U = upper range [$f_U/2$ to f_U]
 m = mid band [$2f_L$ to $f_U/2$]

Typical Performance Data

Frequency (MHz)		Conversion Loss (dB)	Isolation L-R (dB)	Isolation L-I (dB)	VSWR RF Port (:1)	VSWR LO Port (:1)
RF	LO	LO +13dBm	LO +13dBm	LO +13dBm	LO +13dBm	LO +13dBm
2.00	32.00	6.40	61.50	52.50	1.48	2.37
5.00	35.00	5.96	60.83	51.00	1.24	2.37
10.00	40.00	5.71	60.00	51.00	1.15	2.46
20.00	50.00	5.63	58.00	49.67	1.10	2.51
35.10	65.10	5.49	55.50	48.00	1.08	2.46
50.00	80.00	5.62	53.83	46.17	1.07	2.41
70.09	100.09	5.57	53.01	44.50	1.06	2.46
105.09	135.09	5.52	50.16	40.67	1.05	2.36
140.08	170.08	5.48	48.66	41.00	1.05	2.41
175.08	205.08	5.74	50.67	40.00	1.09	2.36
210.07	240.07	5.82	48.84	39.50	1.11	2.46
245.07	275.07	5.78	47.00	38.17	1.12	2.51
250.00	280.00	5.79	46.83	38.17	1.12	2.46
280.06	310.06	5.71	47.00	37.17	1.12	2.51
350.05	380.05	5.82	43.50	35.17	1.14	2.51
385.05	415.05	5.92	41.17	33.00	1.19	2.61
420.04	450.04	5.88	39.83	30.67	1.24	2.67
470.00	500.00	5.72	38.50	30.67	1.27	2.67
490.03	520.03	5.86	38.00	30.34	1.26	2.79
500.00	530.00	5.67	37.33	30.33	1.26	2.67

Electrical Schematic

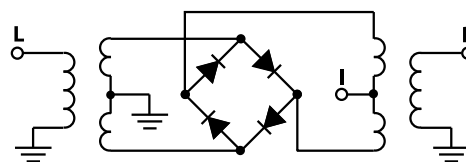

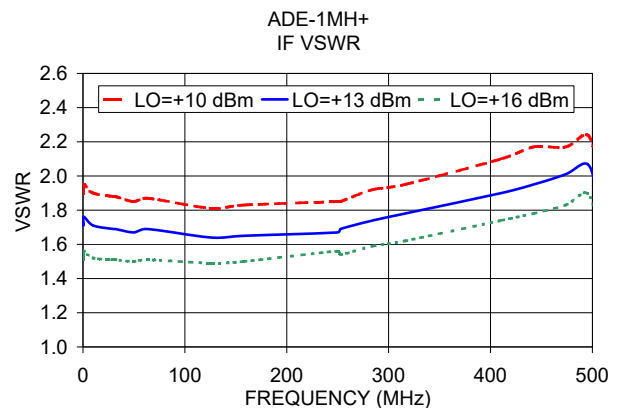
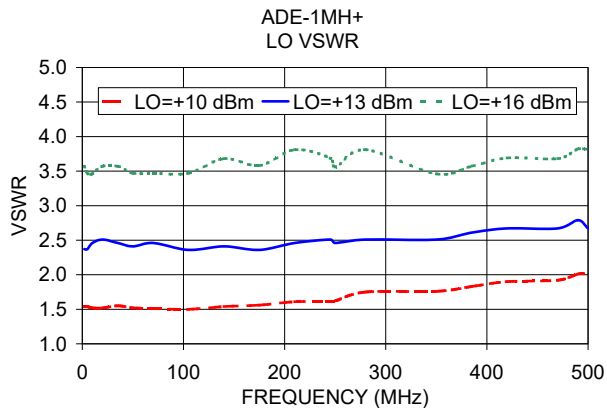
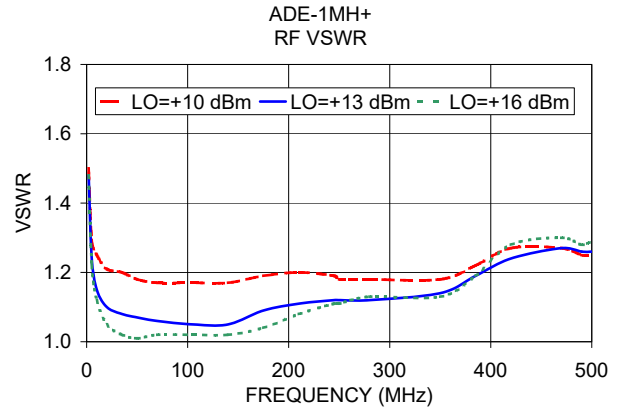
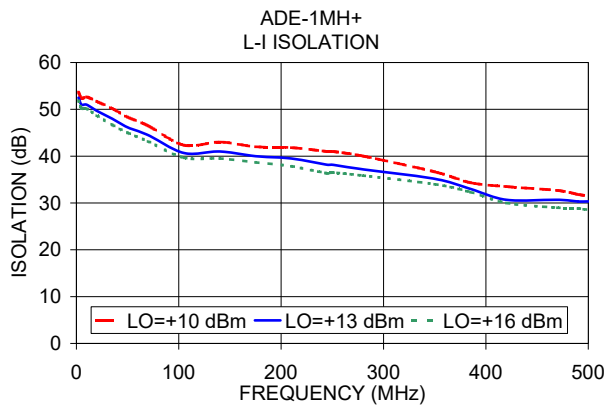
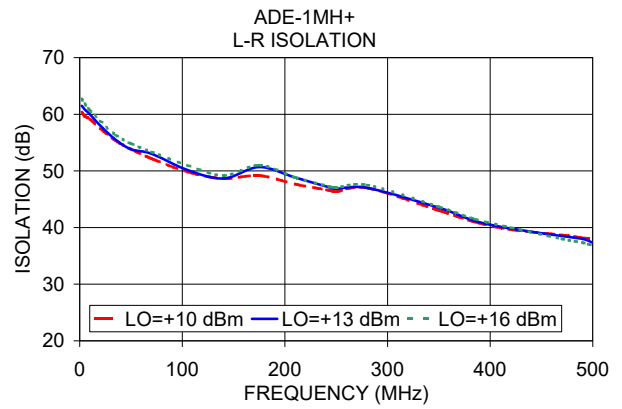
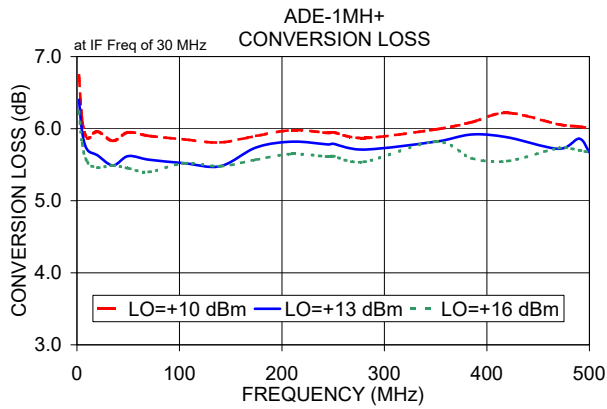

Notes

- A. Performance and quality attributes and conditions not expressly stated in this specification document are intended to be excluded and do not form a part of this specification document.
- B. Electrical specifications and performance data contained in this specification document are based on Mini-Circuit's applicable established test performance criteria and measurement instructions.
- C. The parts covered by this specification document are subject to Mini-Circuits standard limited warranty and terms and conditions (collectively, "Standard Terms"); Purchasers of this part are entitled to the rights and benefits contained therein. For a full statement of the Standard Terms and the exclusive rights and remedies thereunder, please visit Mini-Circuits' website at www.minicircuits.com/MCLStore/terms.jsp



Frequency Mixer

ADE-1MH+

Typical Performance Data

RF (IN) (MHz)	LO (MHz)	CONVERSION LOSS IF FIXED @IF(OUT)=30MHz (dB)			RF (IN) (MHz)	LO (MHz)	IP3 INPUT (dBm)			RF (IN) (MHz)	LO (MHz)	COMPRESSION @RF IN=+9dBm (dB)		
		@LO (dBm)					@LO (dBm)					@LO (dBm)		
		+10	+13	+16			+10	+13	+16			+10	+13	+16
2.0	32.0	6.74	6.40	6.24	10.1	40.1	24.69	29.56	29.78	10.1	40.1	1.77	1.56	1.38
5.0	35.0	6.13	5.96	5.80	50.4	80.4	24.84	27.76	31.13	50.4	80.4	1.70	1.49	1.31
10.0	40.0	5.87	5.71	5.54	90.7	120.7	25.46	29.26	26.25	90.7	120.7	1.70	1.51	1.32
50.4	80.4	5.63	5.32	5.20	131.0	161.0	25.66	25.70	23.80	131.0	161.0	1.74	1.51	1.31
90.7	120.7	5.63	5.31	5.20	171.3	201.3	25.00	22.68	25.70	171.3	201.3	1.64	1.41	1.24
131.0	161.0	5.57	5.33	5.23	211.5	241.5	21.01	21.79	24.71	211.5	241.5	1.67	1.45	1.28
171.3	201.3	5.59	5.37	5.26	251.8	281.8	24.59	25.18	25.26	251.8	281.8	1.61	1.35	1.21
211.5	241.5	5.58	5.36	5.25	292.1	322.1	18.13	17.41	18.43	292.1	322.1	1.57	1.35	1.22
251.8	281.8	5.62	5.42	5.32	332.4	362.4	20.46	19.33	20.46	332.4	362.4	1.56	1.33	1.19
292.1	322.1	5.66	5.47	5.35	372.7	402.7	18.70	25.03	31.11	372.7	402.7	1.46	1.38	1.18
332.4	362.4	5.68	5.50	5.40	413.0	443.0	15.32	15.18	18.00	413.0	443.0	1.47	1.31	1.21
372.7	402.7	5.89	5.51	5.33	453.3	483.3	17.44	16.85	17.09	453.3	483.3	1.57	1.35	1.22
453.3	483.3	5.96	5.78	5.65	493.6	523.6	22.94	24.72	23.84	493.6	523.6	1.82	1.54	1.41
493.6	523.6	5.94	5.71	5.54	533.9	563.9	24.43	20.44	24.25	533.9	563.9	2.08	1.59	1.38
533.9	563.9	5.86	5.59	5.48	574.2	604.2	17.79	26.76	29.76	574.2	604.2	2.36	1.86	1.60
574.2	604.2	6.02	5.68	5.55	614.4	644.4	10.44	19.42	29.07	614.4	644.4	2.40	2.27	1.91
614.4	644.4	6.50	5.87	5.64	654.7	684.7	7.73	10.25	17.30	654.7	684.7	2.40	2.28	2.12
654.7	684.7	6.94	6.42	5.85	695.0	725.0	7.70	8.08	10.47	695.0	725.0	2.38	2.25	2.20
695.0	725.0	7.39	6.90	6.32	735.3	765.3	8.36	8.41	9.00	735.3	765.3	2.12	2.06	2.01
735.3	765.3	7.95	7.43	6.93	775.6	805.6	9.79	10.45	11.52	775.6	805.6	1.78	1.79	1.84
775.6	805.6	8.44	7.90	7.36	815.9	845.9	12.18	13.74	16.47	815.9	845.9	1.70	1.78	1.89
815.9	845.9	8.60	7.96	7.28	856.2	886.2	13.08	17.28	19.76	856.2	886.2	1.82	1.96	1.86
856.2	886.2	8.48	7.65	7.01	896.5	926.5	14.73	20.26	22.40	896.5	926.5	2.20	2.18	2.03
896.5	926.5	8.03	7.11	6.53	916.6	946.6	16.93	25.15	22.71	916.6	946.6	2.34	2.21	2.01
956.9	986.9	7.32	6.80	6.55	956.9	986.9	20.28	20.96	22.95	956.9	986.9	2.60	2.24	1.98
977.1	1007.1	7.25	6.84	6.65	977.1	1007.1	19.62	21.19	22.63	977.1	1007.1	2.49	2.13	1.87
1017.3	1047.3	7.36	7.02	6.85	1017.3	1047.3	19.82	21.37	22.78	1017.3	1047.3	2.22	1.91	1.71
1037.5	1067.5	7.45	7.16	6.98	1037.5	1067.5	19.53	21.13	22.48	1037.5	1067.5	2.06	1.77	1.62
1077.8	1107.8	7.73	7.42	7.25	1077.8	1107.8	18.86	20.58	21.75	1077.8	1107.8	1.81	1.61	1.51
1097.9	1127.9	7.92	7.58	7.41	1097.9	1127.9	18.91	20.27	21.40	1097.9	1127.9	1.80	1.63	1.54
1138.2	1168.2	8.34	8.04	7.86	1138.2	1168.2	19.28	19.59	20.79	1138.2	1168.2	1.70	1.44	1.39
1158.4	1188.4	8.55	8.28	8.14	1158.4	1188.4	18.59	18.89	19.45	1158.4	1188.4	1.67	1.39	1.33
1198.7	1228.7	8.83	8.64	8.55	1198.7	1228.7	17.86	19.12	19.77	1198.7	1228.7	1.67	1.25	1.16
1218.8	1248.8	8.96	8.81	8.77	1218.8	1248.8	17.92	20.14	21.10	1218.8	1248.8	1.65	1.19	1.06
1259.1	1289.1	9.24	9.09	9.08	1259.1	1289.1	17.07	20.35	21.75	1259.1	1289.1	1.73	1.21	0.98
1279.2	1309.2	9.42	9.22	9.28	1279.2	1309.2	16.77	19.46	21.22	1279.2	1309.2	1.76	1.17	0.90
1319.5	1349.5	9.87	9.71	9.75	1319.5	1349.5	16.07	18.52	20.72	1319.5	1349.5	1.82	1.10	0.79
1339.7	1369.7	10.13	9.92	9.98	1339.7	1369.7	16.17	19.06	21.16	1339.7	1369.7	1.73	1.00	0.69
1380.0	1410.0	10.70	10.48	10.52	1380.0	1410.0	15.64	19.80	21.70	1380.0	1410.0	1.84	0.97	0.67
1400.1	1430.1	10.96	10.76	10.75	1400.1	1430.1	15.90	20.62	20.51	1400.1	1430.1	1.77	0.92	0.63



Frequency Mixer

ADE-1MH+

Typical Performance Data

IF (OUT) (MHz)	LO (MHz)	CONVERSION LOSS VS. IF FREQUENCY @RF(IN)=250.1MHz (dB)	IF (OUT) (MHz)	LO (MHz)	CONVERSION LOSS VS. IF FREQUENCY @RF(IN)=10.1MHz (dB)	IF (OUT) (MHz)	LO (MHz)	CONVERSION LOSS VS. IF FREQUENCY @RF(IN)=500.1MHz (dB)
		@LO (dBm)			@LO (dBm)			@LO (dBm)
		+13			+13			+13
240.0	10.1	5.46	10.0	20.1	5.19	490.0	10.1	5.68
234.1	16.0	5.45	22.3	32.4	5.04	477.7	22.4	5.68
228.2	21.9	5.43	34.6	44.7	5.01	465.4	34.7	5.63
222.3	27.8	5.43	46.9	57.0	5.01	453.1	47.0	5.61
216.4	33.7	5.41	59.2	69.3	4.98	440.8	59.3	5.63
210.5	39.6	5.40	71.5	81.6	5.00	428.5	71.6	5.57
204.6	45.5	5.39	83.8	93.9	5.01	416.2	83.9	5.52
198.7	51.4	5.36	96.2	106.3	5.01	403.8	96.3	5.47
192.8	57.3	5.35	108.5	118.6	5.02	391.5	108.6	5.44
186.9	63.2	5.32	120.8	130.9	5.01	379.2	120.9	5.45
181.0	69.1	5.33	133.1	143.2	5.01	366.9	133.2	5.46
175.1	75.0	5.34	145.4	155.5	5.06	354.6	145.5	5.44
169.2	80.9	5.31	157.7	167.8	5.06	342.3	157.8	5.45
163.3	86.8	5.29	170.0	180.1	5.05	330.0	170.1	5.46
157.4	92.7	5.29	182.3	192.4	5.07	317.7	182.4	5.46
151.5	98.6	5.27	194.6	204.7	5.08	305.4	194.7	5.49
145.6	104.5	5.29	206.9	217.0	5.08	293.1	207.0	5.47
139.7	110.4	5.29	219.2	229.3	5.08	280.8	219.3	5.47
133.8	116.3	5.27	231.5	241.6	5.09	268.5	231.6	5.49
127.9	122.2	5.24	243.8	253.9	5.13	256.2	243.9	5.51
122.1	128.0	5.23	256.2	266.3	5.14	243.8	256.3	5.53
116.2	133.9	5.26	268.5	278.6	5.12	231.5	268.6	5.52
110.3	139.8	5.28	280.8	290.9	5.14	219.2	280.9	5.49
104.4	145.7	5.28	293.1	303.2	5.17	206.9	293.2	5.52
98.5	151.6	5.28	305.4	315.5	5.20	194.6	305.5	5.54
92.6	157.5	5.27	317.7	327.8	5.25	182.3	317.8	5.56
86.7	163.4	5.28	330.0	340.1	5.24	170.0	330.1	5.60
80.8	169.3	5.29	342.3	352.4	5.20	157.7	342.4	5.62
74.9	175.2	5.30	354.6	364.7	5.19	145.4	354.7	5.64
69.0	181.1	5.29	366.9	377.0	5.17	133.1	367.0	5.65
63.1	187.0	5.28	379.2	389.3	5.14	120.8	379.3	5.60
57.2	192.9	5.28	391.5	401.6	5.13	108.5	391.6	5.56
51.3	198.8	5.30	403.8	413.9	5.15	96.2	403.9	5.56
45.4	204.7	5.33	416.2	426.3	5.28	83.8	416.3	5.58
39.5	210.6	5.36	428.5	438.6	5.37	71.5	428.6	5.68
33.6	216.5	5.35	440.8	450.9	5.40	59.2	440.9	5.73
27.7	222.4	5.36	453.1	463.2	5.42	46.9	453.2	5.72
21.8	228.3	5.40	465.4	475.5	5.42	34.6	465.5	5.77
15.9	234.2	5.44	477.7	487.8	5.43	22.3	477.8	5.80
10.0	240.1	5.56	490.0	500.1	5.46	10.0	490.1	5.95

Frequency Mixer

ADE-1MH+

Typical Performance Data

LO (MHz)	LO-RF ISOLATION (dB)			LO-IF ISOLATION (dB)		
	@LO (dBm)			@LO (dBm)		
	+10	+13	+16	+10	+13	+16
2.0	60.3	61.5	62.7	53.7	52.5	51.8
5.0	59.7	60.8	61.8	52.3	51.0	50.2
10.0	59.2	60.0	60.7	52.7	51.0	50.2
50.4	56.23	56.29	56.32	57.82	55.74	54.39
90.7	51.52	51.73	51.99	52.52	50.61	49.51
131.0	48.90	49.34	49.22	49.20	47.71	47.12
171.3	47.48	47.71	47.43	47.06	46.24	45.51
211.5	46.08	45.98	45.58	46.15	45.30	44.23
251.8	44.99	44.89	44.50	45.73	44.23	43.07
292.1	43.62	43.11	42.72	45.84	44.15	42.55
332.4	42.89	42.49	41.84	44.83	42.31	40.41
372.7	42.17	41.84	41.35	44.75	41.96	39.66
453.3	38.12	37.82	37.45	38.78	36.67	35.45
493.6	36.79	36.63	36.22	38.62	35.90	34.27
533.9	34.87	34.43	33.85	38.72	35.10	32.65
574.2	34.63	33.92	33.21	39.44	35.16	32.22
614.4	34.88	33.68	32.49	36.14	33.81	31.48
654.7	34.09	33.06	31.88	33.90	32.10	29.94
695.0	33.37	32.37	31.16	31.24	30.44	28.83
735.3	32.58	31.91	30.71	29.28	28.24	27.07
775.6	32.06	31.41	30.34	28.25	26.99	25.87
815.9	31.73	31.15	30.21	27.43	26.16	24.95
856.2	31.60	31.06	30.33	27.07	25.98	24.53
896.5	31.23	30.61	29.83	27.38	26.29	23.96
956.9	31.00	30.09	29.57	26.43	23.93	21.87
977.1	30.96	30.10	29.53	25.38	23.12	21.25
1017.3	31.42	30.58	30.12	22.63	21.13	19.68
1037.5	31.93	31.05	30.64	21.57	20.47	19.17
1077.8	32.88	31.54	30.99	19.64	19.12	18.05
1097.9	33.10	31.28	30.48	18.72	18.40	17.39
1138.2	33.63	30.69	29.37	17.29	17.46	16.64
1158.4	33.50	30.12	28.61	16.68	17.05	16.32
1198.7	32.63	28.49	26.54	15.46	16.19	15.71
1218.8	32.25	27.80	25.70	14.89	15.89	15.59
1259.1	30.33	26.28	24.17	13.97	15.20	15.10
1279.2	29.23	25.38	23.27	13.63	14.99	14.95
1319.5	27.16	24.07	22.03	12.81	14.42	14.54
1339.7	26.29	23.53	21.58	12.60	14.30	14.45
1380.0	24.26	22.40	20.60	11.94	13.86	14.25
1400.1	23.29	21.88	20.22	11.47	13.51	14.16

RF (IN) (MHz)	LO (MHz)	RF-IF ISOLATION (dB)		
		@LO (dBm)		
		+10	+13	+16
10.1	40.1	42.25	44.24	42.96
50.4	80.4	31.93	31.92	31.74
90.7	120.7	27.44	27.52	27.55
131.0	161.0	24.82	24.97	25.05
171.3	201.3	23.28	23.40	23.50
211.5	241.5	22.18	22.31	22.42
251.8	281.8	21.81	21.95	21.98
292.1	322.1	21.31	21.54	21.90
332.4	362.4	21.36	21.72	21.98
372.7	402.7	21.84	22.15	22.47
413.0	443.0	22.85	23.04	23.21
453.3	483.3	23.59	24.01	24.46
493.6	523.6	23.52	24.03	24.68
533.9	563.9	22.67	23.58	24.22
574.2	604.2	20.59	20.58	20.47
614.4	644.4	19.02	18.42	18.06
654.7	684.7	17.57	17.34	16.86
695.0	725.0	16.63	16.39	16.28
735.3	765.3	16.40	16.08	15.89
775.6	805.6	16.16	15.88	15.71
815.9	845.9	15.83	15.61	15.73
856.2	886.2	15.51	15.36	15.21
896.5	926.5	15.00	14.54	14.29
916.6	946.6	14.70	14.31	14.23
956.9	986.9	14.39	14.30	14.31
977.1	1007.1	14.37	14.30	14.28
1017.3	1047.3	14.32	14.24	14.15
1037.5	1067.5	14.24	14.15	14.03
1077.8	1107.8	13.95	13.83	13.62
1097.9	1127.9	13.76	13.69	13.50
1138.2	1168.2	13.08	13.09	13.02
1158.4	1188.4	12.61	12.59	12.52
1198.7	1228.7	11.47	11.27	11.08
1218.8	1248.8	10.87	10.56	10.28
1259.1	1289.1	9.74	9.32	8.93
1279.2	1309.2	9.29	8.84	8.43
1319.5	1349.5	8.33	7.86	7.44
1339.7	1369.7	7.88	7.40	6.98
1380.0	1410.0	7.09	6.63	6.26
1400.1	1430.1	6.71	6.27	5.93



Frequency Mixer

ADE-1MH+

Typical Performance Data

RF (IN) (MHz)	LO (MHz)	RF VSWR (:1)		
		@LO (dBm)		
		+10	+13	+16
2.0	32.0	1.50	1.48	1.48
5.0	35.0	1.29	1.24	1.22
10.0	40.0	1.25	1.15	1.12
50.4	80.4	1.18	1.08	1.02
90.7	120.7	1.18	1.08	1.03
131.0	161.0	1.17	1.08	1.05
171.4	201.4	1.16	1.08	1.07
211.7	241.7	1.16	1.09	1.09
252.0	282.0	1.16	1.11	1.11
292.3	322.3	1.17	1.14	1.14
332.6	362.6	1.16	1.14	1.14
372.9	402.9	1.20	1.16	1.19
413.2	443.2	1.23	1.19	1.19
453.5	483.5	1.24	1.22	1.22
493.9	523.9	1.25	1.25	1.27
514.0	544.0	1.24	1.27	1.31
554.3	584.3	1.24	1.29	1.32
574.5	604.5	1.23	1.27	1.30
614.8	644.8	1.26	1.23	1.26
634.9	664.9	1.31	1.23	1.24
675.3	705.3	1.42	1.34	1.29
695.4	725.4	1.49	1.41	1.35
735.7	765.7	1.71	1.62	1.56
755.9	785.9	1.84	1.75	1.68
796.2	826.2	2.06	1.96	1.88
816.4	846.4	2.17	2.07	1.97
856.7	886.7	2.34	2.21	2.12
876.8	906.8	2.41	2.27	2.19
917.1	947.1	2.51	2.38	2.33
937.3	967.3	2.54	2.44	2.40
977.6	1007.6	2.64	2.57	2.53
997.8	1027.8	2.68	2.62	2.57
1038.1	1068.1	2.82	2.75	2.69
1058.2	1088.2	2.90	2.82	2.76
1098.5	1128.5	3.04	2.95	2.88
1118.7	1148.7	3.12	3.02	2.95
1159.0	1189.0	3.18	3.11	3.05
1179.2	1209.2	3.19	3.12	3.07
1219.5	1249.5	3.19	3.11	3.07
1239.6	1269.6	3.17	3.08	3.02
1279.9	1309.9	3.13	3.01	2.97
1300.1	1330.1	3.06	2.95	2.91

LO (MHz)	LO VSWR (:1)		
	@LO (dBm)		
	+10	+13	+16
32.0	1.54	2.37	3.57
35.0	1.54	2.37	3.47
40.0	1.52	2.46	3.46
80.4	1.49	2.32	3.40
120.7	1.49	2.30	3.35
161.0	1.49	2.30	3.34
201.4	1.50	2.30	3.31
241.7	1.54	2.31	3.30
282.0	1.57	2.34	3.33
322.3	1.62	2.37	3.31
362.6	1.67	2.43	3.41
402.9	1.76	2.50	3.47
443.2	1.80	2.55	3.50
483.5	1.85	2.61	3.60
523.9	1.85	2.55	3.47
544.0	1.87	2.52	3.41
584.3	1.98	2.57	3.42
604.5	2.21	2.79	3.61
644.8	2.31	3.00	3.79
664.9	2.32	3.06	3.92
705.3	2.36	3.11	4.01
725.4	2.33	3.03	3.90
765.7	2.33	3.00	3.85
785.9	2.31	2.93	3.72
826.2	2.25	2.83	3.58
846.4	2.26	2.86	3.62
886.7	2.18	2.77	3.57
906.8	2.17	2.77	3.57
947.1	2.33	2.94	3.72
967.3	2.41	2.96	3.69
1007.6	2.64	3.10	3.76
1027.8	2.78	3.21	3.87
1068.1	3.03	3.36	3.95
1088.2	3.14	3.43	3.96
1128.5	3.35	3.56	4.05
1148.7	3.46	3.62	4.07
1189.0	3.61	3.75	4.13
1209.2	3.65	3.80	4.19
1249.5	3.68	3.87	4.24
1269.6	3.69	3.91	4.28
1309.9	3.65	3.91	4.28
1330.1	3.58	3.86	4.23

IF (OUT) (MHz)	IF VSWR @LO=500.5MHz (:1)		
	@LO (dBm)		
	+10	+13	+16
0.1	1.90	1.73	1.52
0.3	1.90	1.71	1.51
0.5	1.92	1.72	1.54
1.0	1.95	1.76	1.56
10.0	1.90	1.71	1.52
22.4	1.75	1.64	1.54
34.6	1.72	1.59	1.50
46.9	1.75	1.62	1.51
59.1	1.79	1.66	1.54
71.4	1.80	1.66	1.54
83.6	1.80	1.66	1.55
95.9	1.79	1.67	1.55
108.1	1.78	1.65	1.53
120.4	1.80	1.66	1.55
132.6	1.82	1.68	1.57
144.9	1.83	1.69	1.57
157.1	1.83	1.69	1.57
169.4	1.82	1.69	1.57
181.6	1.83	1.70	1.58
193.9	1.87	1.74	1.61
218.4	1.89	1.76	1.63
230.6	1.87	1.73	1.61
242.9	1.87	1.73	1.61
255.1	1.89	1.75	1.62
267.4	1.90	1.77	1.64
279.6	1.92	1.78	1.66
291.9	1.92	1.78	1.66
304.1	1.91	1.77	1.65
316.4	1.91	1.77	1.65
328.6	1.93	1.80	1.67
340.9	1.96	1.82	1.69
353.1	1.96	1.83	1.70
365.4	1.96	1.82	1.70
377.6	1.97	1.84	1.71
389.9	2.00	1.86	1.73
402.1	2.03	1.89	1.77
414.4	2.07	1.93	1.80
438.9	2.04	1.90	1.78
451.1	2.04	1.91	1.78
463.4	2.07	1.93	1.80
487.9	2.12	1.99	1.87
500.1	2.10	1.99	1.88

Harmonics Tables

RF HARMONICS ORDER

	(-dBm)	(-dBc)										
0	-	-	20	25	21	33	18	37	29	45	30	48
1	-	17	+0	26	12	31	17	34	31	41	40	47
2	>100	70	57	66	57	65	54	66	50	62	63	72
3	>100	66	68	73	61	75	55	74	55	70	58	75
4	>100	88	77	>89	77	>89	78	83	77	87	84	>89
5	>100	86	81	>89	78	>89	80	>89	78	87	76	87
6	>100	>89	>89	>89	>89	>89	>89	>89	>89	>89	>89	>89
7	>100	>89	>89	>89	>89	>89	>89	>89	>89	>89	>89	>89
8	>100	>89	>89	>89	>89	>89	>89	>89	>89	>89	>89	>89
9	>100	>89	>89	>89	>89	>89	>89	>89	>89	70	>89	>89
10	>100	>89	>89	>89	>89	>89	>89	>89	>89	>89	77	>89
	RF CAL	0	1	2	3	4	5	6	7	8	9	10

LO HARMONICS ORDER

Test conditions: RF IN: 250.1 MHz; -6.00 dBm.
 LO IN: 280.01 MHz; +13.00 dBm
 IF OUT: 29.91 MHz; -11.36 dBm

RF HARMONICS ORDER

	(-dBm)	(-dBc)										
0	-	-	29	35	34	46	31	48	43	59	49	65
1	-	17	+0	27	12	34	18	34	32	47	46	54
2	87	71	46	59	47	71	47	61	44	61	57	65
3	>100	41	45	46	46	47	42	45	40	58	51	55
4	>100	67	68	66	68	66	65	63	59	68	56	66
5	>100	75	59	57	51	61	48	57	46	63	47	60
6	>100	82	75	81	75	85	73	>99	70	75	68	73
7	>100	76	73	74	72	68	72	65	65	62	59	61
8	>100	91	88	85	84	88	80	83	80	77	76	74
9	>100	89	80	84	72	73	71	69	71	70	70	70
10	>100	98	93	>99	92	90	84	88	85	92	79	89
	RF CAL	0	1	2	3	4	5	6	7	8	9	10

LO HARMONICS ORDER

Test conditions: RF IN: 250.1 MHz; 4.00 dBm.
 LO IN: 280.01 MHz; +13.00 dBm
 IF OUT: 29.91 MHz; -1.43 dBm

- Notes: 1. All Harmonics are in (dBc) relative to IF OUTPUT.
 2. + entry denotes harmonics are in (dBc) above IF OUTPUT.
 3. RF Cal represent the Harmonics level of the RF input signal to the mixer.

REV. X2
 ADE-1MH+
 100817
 Page 5 of 5



IF/RF MICROWAVE COMPONENTS • ISO 9001 ISO 14001 AS 9100 CERTIFIED • RoHS compliant
 P.O. Box 350166, Brooklyn, New York 11235-0006 (718) 934-4500 Fax (718) 332-4661



The Design Engineers Search Engine finds the model you need, Instantly • For detailed performance specs & shopping online see minicircuits.com

Typical Performance Curves

Conversion Loss @ IF=30MHz

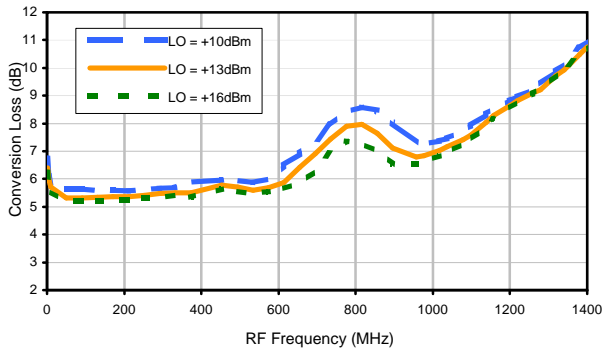

Conversion Loss vs. IF @ RF=250.1MHz

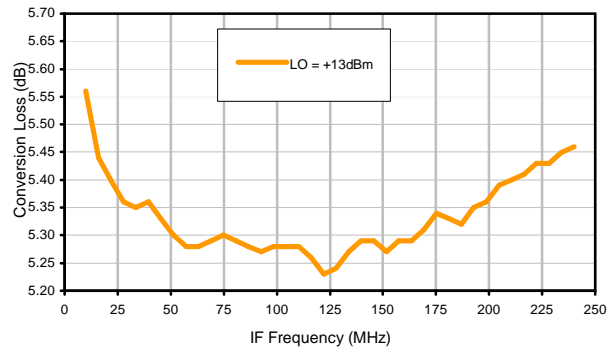

Conversion Loss vs. IF @ RF=10.1MHz

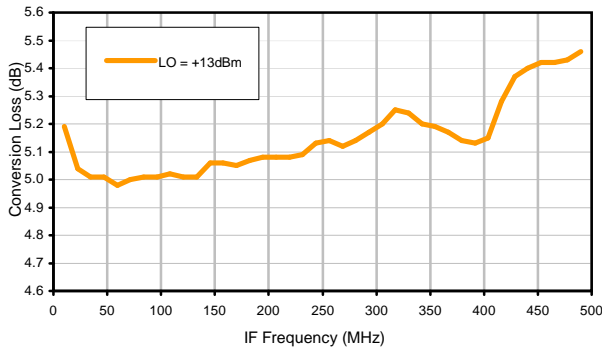

Conversion Loss vs. IF @ RF=500.1MHz

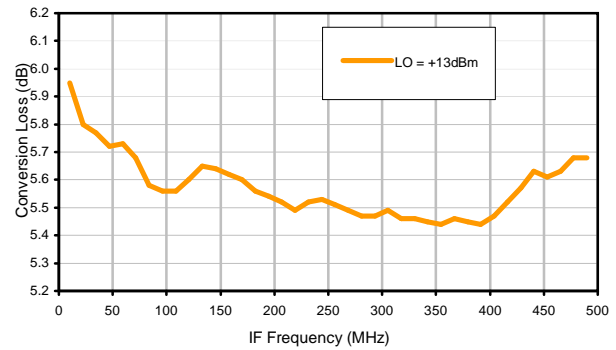

IP3 Input

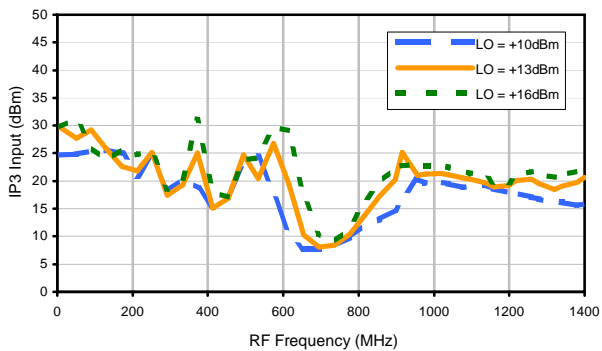

Compression @ RF IN=+9dBm

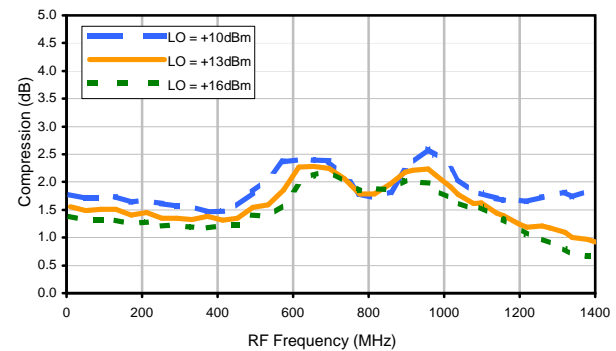

Typical Performance Curves

LO-RF Isolation

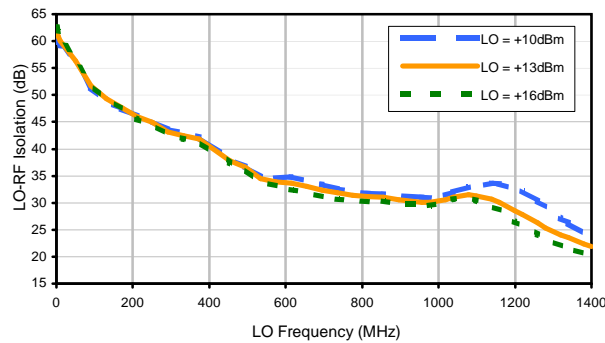

LO-IF Isolation

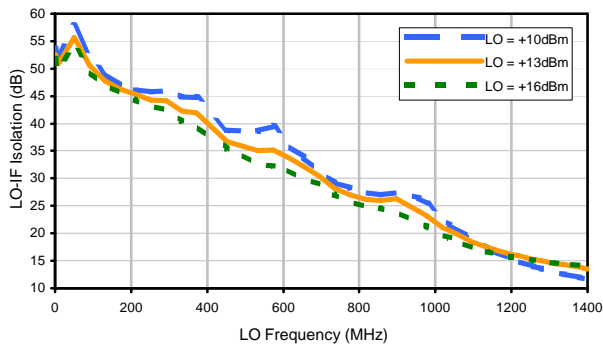

RF-IF Isolation

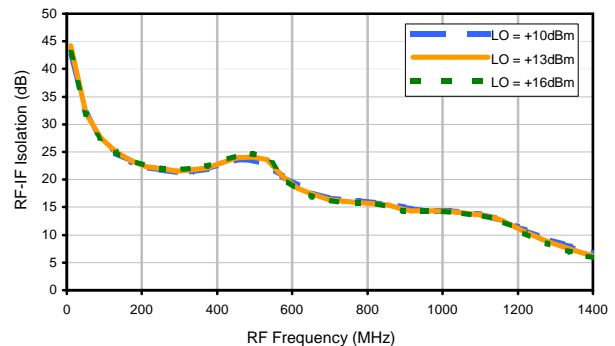

RF VSWR



LO VSWR

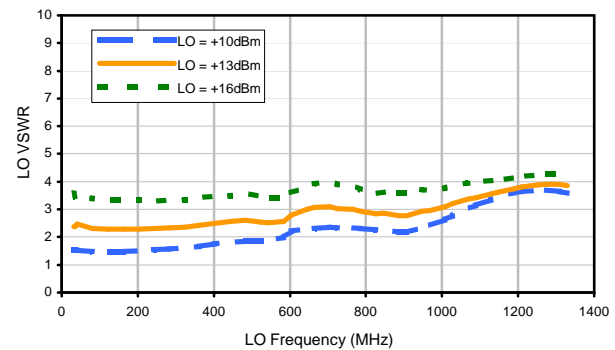

IF VSWR

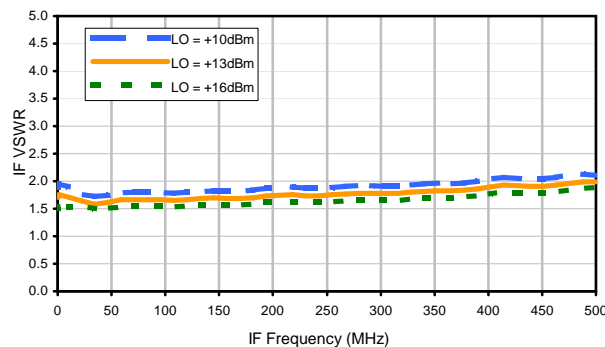

Harmonics Tables

RF HARMONICS ORDER

	(-dBm)	(-dBc)										
0	-	-	20	25	21	33	18	37	29	45	30	48
1	-	17	+0	26	12	31	17	34	31	41	40	47
2	>100	70	57	66	57	65	54	66	50	62	63	72
3	>100	66	68	73	61	75	55	74	55	70	58	75
4	>100	88	77	>89	77	>89	78	83	77	87	84	>89
5	>100	86	81	>89	78	>89	80	>89	78	87	76	87
6	>100	>89	>89	>89	>89	>89	>89	>89	>89	>89	>89	>89
7	>100	>89	>89	>89	>89	>89	>89	>89	>89	>89	>89	>89
8	>100	>89	>89	>89	>89	>89	>89	>89	>89	>89	>89	>89
9	>100	>89	>89	>89	>89	>89	>89	>89	>89	70	>89	>89
10	>100	>89	>89	>89	>89	>89	>89	>89	>89	>89	77	>89
	RF CAL	0	1	2	3	4	5	6	7	8	9	10

LO HARMONICS ORDER

Test conditions: RF IN: 250.1 MHz; -6.00 dBm.
 LO IN: 280.01 MHz; +13.00 dBm
 IF OUT: 29.91 MHz; -11.36 dBm

RF HARMONICS ORDER

	(-dBm)	(-dBc)										
0	-	-	29	35	34	46	31	48	43	59	49	65
1	-	17	+0	27	12	34	18	34	32	47	46	54
2	87	71	46	59	47	71	47	61	44	61	57	65
3	>100	41	45	46	46	47	42	45	40	58	51	55
4	>100	67	68	66	68	66	65	63	59	68	56	66
5	>100	75	59	57	51	61	48	57	46	63	47	60
6	>100	82	75	81	75	85	73	>99	70	75	68	73
7	>100	76	73	74	72	68	72	65	65	62	59	61
8	>100	91	88	85	84	88	80	83	80	77	76	74
9	>100	89	80	84	72	73	71	69	71	70	70	70
10	>100	98	93	>99	92	90	84	88	85	92	79	89
	RF CAL	0	1	2	3	4	5	6	7	8	9	10

LO HARMONICS ORDER

Test conditions: RF IN: 250.1 MHz; 4.00 dBm.
 LO IN: 280.01 MHz; +13.00 dBm
 IF OUT: 29.91 MHz; -1.43 dBm

- Notes: 1. All Harmonics are in (dBc) relative to IF OUTPUT.
 2. + entry denotes harmonics are in (dBc) above IF OUTPUT.
 3. RF Cal represent the Harmonics level of the RF input signal to the mixer.

REV. X2
 ADE-1MH+
 100817
 Page 3 of 3



IF/RF MICROWAVE COMPONENTS • ISO 9001 ISO 14001 AS 9100 CERTIFIED • RoHS compliant
 P.O. Box 350166, Brooklyn, New York 11235-0006 (718) 934-4500 Fax (718) 332-4661



The Design Engineers Search Engine finds the model you need, Instantly • For detailed performance specs & shopping online see minicircuits.com

Case Style

CD

CD541
CD542
CD636
CD637

Outline Dimensions



PCB Land Pattern



Suggested Layout,
Tolerance to be within $\pm .002$

CASE#	A	B	C	D	E	F	G	H	J	K	L	WT, GRAM
CD541					.082 (2.08)							.15
CD542	.272 (6.91)	.310 (7.87)	.220 (5.58)	.100 (2.54)	.112 (2.84)	.055 (1.40)	.100 (2.54)	.030 (0.76)	.026 (0.66)	.065 (1.65)	.300 (7.62)	.20
CD636					.162 (4.11)							.25
CD637					.206 (5.23)							.40

Dimensions are in inches (mm). Tolerances: 2 Pl. $\pm .01$; 3 Pl. $\pm .005$

Notes:

- Case material: Plastic.
- Termination finish:
 - For RoHS Case Styles: Tin plate over Nickel plate. All models, (+) suffix.
 - For RoHS-5 Case Styles: Tin-Lead plate. All models, no (+) suffix.

Mini-Circuits®

INTERNET <http://www.minicircuits.com>

P.O. Box 350166, Brooklyn, New York 11235-0003 (718) 934-4500 Fax (718) 332-4661

Distribution Centers NORTH AMERICA 800-654-7949 • 417-335-5935 • Fax 417-335-5945 • EUROPE 44-1252-832600 • Fax 44-1252-837010

Mini-Circuits ISO 9001 & ISO 14001 Certified

Tape & Reel Packaging TR-F34



Tape Width, mm	Device Cavity Pitch, mm	Reel Size, inches	Devices per Reel see note	
16	12	7	Small quantity standard (see note)	20
				50
			Standard	100
				200
		13	Standard	500
				1000

Note: Availability of small reel quantity varies by model.
Refer to pricing and availability on individual model dashboard.

Mini-Circuits carrier tape materials provide protection from ESD (Electro-Static Discharge) during handling and transportation. Tapes are static dissipative and comply with industry standards EIA-481/EIA-541.

Go to: www.minicircuits.com/pages/pdfs/tape.pdf



INTERNET <http://www.minicircuits.com>

P.O. Box 350166, Brooklyn, New York 11235-0003 (718) 934-4500 Fax (718) 332-4661

Distribution Centers NORTH AMERICA 800-654-7949 • 417-335-5935 • Fax 417-335-5945 • EUROPE 44-1252-832600 • Fax 44-1252-837010

Mini-Circuits ISO 9001 & ISO 14001 Certified

THIRD ANGLE PROJECTION



REVISIONS

REV	ECN No.	DESCRIPTION	DATE	DR	AUTH
A	M101143	ADDED "gk" PIN CONNECTION, TT100 CASE STYLE & NOTE 2	10/10/05	MMG	DJ
B	M102713	ADDED "...WITH SMOBC"	01/17/06	MMG	IL
C	M108637	REMOVED "PIN 1", ADDED INDEX ON UNIT	12/01/06	MYG	FL

**SUGGESTED MOUNTING CONFIGURATION
FOR BH292, CD541/542/636/637, TT100/240 CASE
STYLES, "gk", "ht", "hu", "nd", "w" PIN CONNECTIONS**



- NOTES:** 1. TRACE WIDTH IS SHOWN FOR ROGERS R04350B WITH DIELECTRIC THICKNESS .030" ± .002"; COPPER: 1/2 OZ. EACH SIDE. FOR OTHER MATERIALS TRACE WIDTH MAY NEED TO BE MODIFIED.
2. BOTTOM SIDE OF THE PCB IS CONTINUOUS GROUND PLANE.

- DENOTES PCB COPPER LAYOUT WITH SMOBC (SOLDER MASK OVER BARE COPPER)
- DENOTES COPPER LAND PATTERN FREE OF SOLDER MASK

UNLESS OTHERWISE SPECIFIED	INITIALS	DATE
DIMENSIONS ARE IN INCHES	MMG	07/17/02
TOLERANCES ON: 2 PL DECIMALS ±	WL	08/02/02
3 PL DECIMALS ± .005	DJ	08/05/02
ANGLES ±		
FRACTIONS ±		

Mini-Circuits® 13 Neptune Avenue
Brooklyn NY 11235

**PL, gk/ht/hu/nd/w, BH292,
CD541/542/636/637, TT100/240, TB-03**

SIZE A	CODE IDENT 15542	DRAWING NO: 98-PL-052	REV: C
FILE: 98PL052	SCALE: 8:1	SHEET: 1 OF 1	

Mini-Circuits®
 THIS DOCUMENT AND ITS CONTENTS ARE THE PROPERTY OF MINI-CIRCUITS. EXCEPT FOR USE EXPRESSLY GRANTED, IN WRITING, TO ITS VENDORS, VENDEE AND THE UNITED STATES GOVERNMENT, MINI-CIRCUITS RESERVES ALL PROPRIETARY DESIGN, USE, MANUFACTURING AND REPRODUCTION RIGHTS THERETO. THESE CONTENTS SHALL NOT BE USED, DUPLICATED OR DISCLOSED TO ANY OUTSIDE PARTY, IN WHOLE OR IN PART, WITHOUT WRITTEN PERMISSION OF MINI-CIRCUITS.

THIRD ANGLE PROJECTION



REVISIONS

REV	ECN No.	DESCRIPTION	DATE	DR	AUTH
E	M119737	UPDATED PCB	10.08	MF	AD
F	M127659	UPDATED CARR	06.10	SW	SG
G	M127846	UPDATED SCHEMATIC DIAGRAM	06.10	SW	SG
H	M131840	UPDATED DWG	05.11	MF	AD



NOTES:

1. REFER TO -09 PAGE FOR ITEM DESCRIPTIONS.
DESIGNATION NUMBERS ON -20 PAGE CORRESPOND TO THE NUMBERS ON -09 PAGE.
2. FOR TEXT HEIGHT & STYLE ON THE LABEL REFER TO: D3-G209.

UNLESS OTHERWISE SPECIFIED	INITIALS	DATE
DIMENSIONS ARE IN INCHES TOLERANCES ON: 2 PL DECIMALS ± 3 PL DECIMALS ± ANGLES ± FRACTIONS ±	DRAWN	S.WOLYNSKI 06.29.99
	CHECKED	SG 07.06.99
	APPROVED	MG 07.10.99

 **Mini-Circuits®** 13 Neptune Avenue
Brooklyn NY 11235

TB,ADE,CD542/636,06MX01,50

 Mini-Circuits®
THIS DOCUMENT AND ITS CONTENTS ARE THE PROPERTY OF MINI-CIRCUITS. EXCEPT FOR USE EXPRESSLY GRANTED, IN WRITING, TO ITS VENDORS, VENDEE AND THE UNITED STATES GOVERNMENT, MINI-CIRCUITS RESERVES ALL PROPRIETARY DESIGN, USE, MANUFACTURING AND REPRODUCTION RIGHTS THERETO. THESE CONTENTS SHALL NOT BE USED, DUPLICATED OR DISCLOSED TO ANY OUTSIDE PARTY, IN WHOLE OR IN PART, WITHOUT WRITTEN PERMISSION OF MINI-CIRCUITS.

SIZE A	CODE IDENT 15542	DRAWING NO: TB-03-20	REV: H
FILE: WTB-03	SCALE: 1.5:1	SHEET: 1 OF 2	

Evaluation Board and Circuit

For Pin Connections and DUT Orientation Refer to
Data Sheet of the DUT



TB-03



Schematic Diagram

Notes:

1. 50 Ohm SMA Female connectors.
2. PCB Material: Rogers R04350 or equivalent,
Dielectric Constant=3.5, Thickness=.030 inch.

 **Mini-Circuits®**

All Mini-Circuits products are manufactured under exacting quality assurance and control standards, and are capable of meeting published specifications after being subjected to any or all of the following physical and environmental test.

Specification	Test/Inspection Condition	Reference/Spec
Operating Temperature	-40° to 85°C Ambient Environment	Individual Model Data Sheet
Storage Temperature	-55° to 100° C Ambient Environment	Individual Model Data Sheet
Humidity	90 to 95% RH, 240 hours, 50°C	MIL-STD-202, Method 103, Condition A, Except 50°C and end-point electrical test done within 12 hours
Thermal Shock	-55° to 100°C, 100 cycles	MIL-STD-202, Method 107, Condition A-3, except +100°C
Solder Reflow Heat	Sn-Pb Eutetic Process: 225°C peak Pb-Free Process 245° - 250°C peak	J-STD-020, Table 4-1, 4-2 and 5-2, Figure 5-1
Solderability	10X Magnification	J-STD-002, 95% Coverage
Vibration (High Frequency)	20g peak, 10-2000 Hz, 12 times in each of three perpendicular directions (total 36)	MIL-STD-202, Method 204, Condition D
Mechanical Shock	50g, 11 ms, 1/2-sine, 18 shocks: 3 each direction, each of 3 axes	MIL-STD-202, Method 213, Condition A
Marking Resistance to Solvents	Isopropyl alcohol + mineral spirits at 25°C; terpene defluxer at 25°C; distilled water + proylene glycol monomethyl ether + monoethanolamine at 63°C to 70°C	MIL-STD-202, Method 215