

# Frequency Mixer

**ADE-20**

Level 7 (LO Power +7 dBm) 1500 to 2000 MHz



Generic photo used for illustration purposes only

CASE STYLE: CD542

## Maximum Ratings

|                       |                |
|-----------------------|----------------|
| Operating Temperature | -40°C to 85°C  |
| Storage Temperature   | -55°C to 100°C |
| RF Power              | 50mW           |
| IF Current            | 40mA           |

Permanent damage may occur if any of these limits are exceeded.

## Pin Connections

|        |       |
|--------|-------|
| LO     | 6     |
| RF     | 4     |
| IF     | 3     |
| GROUND | 1,2,5 |

## Outline Drawing

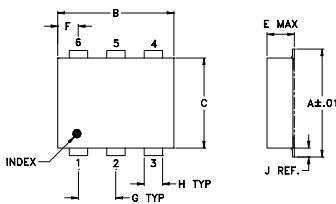

### PCB Land Pattern

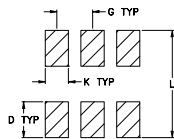

Suggested Layout.  
Tolerance to be within ±.002

## Outline Dimensions (inch/mm)

| A    | B    | C    | D    | E     | F    | G    |
|------|------|------|------|-------|------|------|
| .272 | .310 | .220 | .100 | .112  | .055 | .100 |
| 6.91 | 7.87 | 5.59 | 2.54 | 2.84  | 1.40 | 2.54 |
| H    | J    | K    | L    | wt    |      |      |
| .030 | .026 | .065 | .300 | grams |      |      |
| 0.76 | 0.66 | 1.65 | 7.62 | 0.20  |      |      |

## Demo Board MCL P/N: TB-02 Suggested PCB Layout (PL-051)

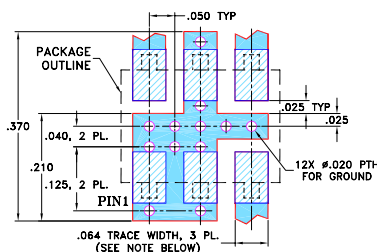

- NOTES: 1. TRACE WIDTH IS SHOWN FOR ROGERS RO4350B WITH DIELECTRIC THICKNESS .050" ± .002"; COPPER: 1/2 OZ, EACH SIDE. FOR OTHER MATERIALS TRACE WIDTH MAY NEED TO BE MODIFIED.  
2. BOTTOM SIDE OF THE PCB IS CONTINUOUS GROUND PLANE.
- DENOTES PCB COPPER LAYOUT WITH SMOBC (SOLDER MASK OVER BARE COPPER)
  - DENOTES COPPER LAND PATTERN FREE OF SOLDER MASK

## Notes

- A. Performance and quality attributes and conditions not expressly stated in this specification document are intended to be excluded and do not form a part of this specification document.  
B. Electrical specifications and performance data contained in this specification document are based on Mini-Circuit's applicable established test performance criteria and measurement instructions.  
C. The parts covered by this specification document are subject to Mini-Circuits standard limited warranty and terms and conditions (collectively, "Standard Terms"); Purchasers of this part are entitled to the rights and benefits contained therein. For a full statement of the Standard Terms and the exclusive rights and remedies thereunder, please visit Mini-Circuits' website at [www.minicircuits.com/MCLStore/terms.jsp](http://www.minicircuits.com/MCLStore/terms.jsp)

## Features

- low conversion loss, 5.4 dB typ.
- excellent isolation, 31 dB typ.
- low profile package
- aqueous washable
- protected by U.S. Patent 6,133,525

## Applications

- digital cellular
- digital cordless phone
- PCN

## Electrical Specifications

| FREQUENCY (MHz) |        | CONVERSION LOSS (dB) |          |      | LO-RF ISOLATION (dB) |      | LO-IF ISOLATION (dB) |      | IP3 at center band (dBm) |
|-----------------|--------|----------------------|----------|------|----------------------|------|----------------------|------|--------------------------|
| LO/RF           | IF     | $\bar{X}$            | $\sigma$ | Max. | Typ.                 | Min. | Typ.                 | Min. | Typ.                     |
| 1500-2000       | DC-300 | 5.4                  | 0.10     | 7.8  | 31                   | 22   | 28                   | 20   | 14                       |

1 dB COMP.: +1 dBm typ.

## Typical Performance Data

| Frequency (MHz) |         | Conversion Loss (dB) | Isolation L-R (dB) | Isolation L-I (dB) | VSWR RF Port (:1) | VSWR LO Port (:1) |
|-----------------|---------|----------------------|--------------------|--------------------|-------------------|-------------------|
| RF              | LO      | LO +7dBm             | LO +7dBm           | LO +7dBm           | LO +7dBm          | LO +7dBm          |
| 1500.00         | 1530.00 | 5.80                 | 37.30              | 31.70              | 1.59              | 1.21              |
| 1535.71         | 1565.71 | 5.77                 | 36.90              | 32.60              | 1.49              | 1.31              |
| 1571.43         | 1601.43 | 5.78                 | 36.50              | 32.90              | 1.46              | 1.41              |
| 1600.00         | 1630.00 | 5.87                 | 36.30              | 32.90              | 1.45              | 1.49              |
| 1607.14         | 1637.14 | 5.76                 | 36.20              | 32.90              | 1.43              | 1.52              |
| 1642.86         | 1672.86 | 5.78                 | 36.00              | 33.00              | 1.40              | 1.57              |
| 1650.00         | 1680.00 | 5.91                 | 36.00              | 33.00              | 1.41              | 1.60              |
| 1678.57         | 1708.57 | 5.87                 | 35.70              | 32.90              | 1.41              | 1.66              |
| 1700.00         | 1730.00 | 5.94                 | 35.40              | 33.10              | 1.40              | 1.68              |
| 1714.29         | 1744.29 | 5.96                 | 35.30              | 33.00              | 1.40              | 1.69              |
| 1750.00         | 1780.00 | 5.97                 | 35.10              | 33.00              | 1.44              | 1.71              |
| 1785.71         | 1815.71 | 5.96                 | 35.20              | 33.00              | 1.48              | 1.70              |
| 1800.00         | 1830.00 | 6.04                 | 35.20              | 33.20              | 1.48              | 1.69              |
| 1821.43         | 1851.43 | 5.97                 | 35.40              | 33.20              | 1.52              | 1.68              |
| 1857.14         | 1887.14 | 5.96                 | 35.70              | 33.20              | 1.59              | 1.67              |
| 1892.86         | 1922.86 | 6.00                 | 36.10              | 33.20              | 1.61              | 1.61              |
| 1900.00         | 1930.00 | 5.98                 | 36.20              | 33.20              | 1.62              | 1.60              |
| 1928.57         | 1958.57 | 5.99                 | 36.30              | 33.20              | 1.70              | 1.57              |
| 1964.29         | 1994.29 | 5.94                 | 36.60              | 33.10              | 1.78              | 1.50              |
| 2000.00         | 2030.00 | 5.93                 | 36.60              | 33.10              | 1.84              | 1.46              |

## Electrical Schematic

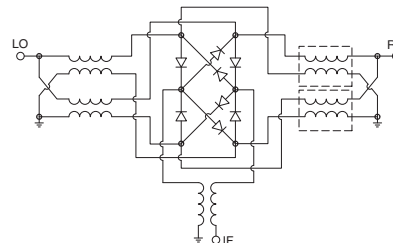

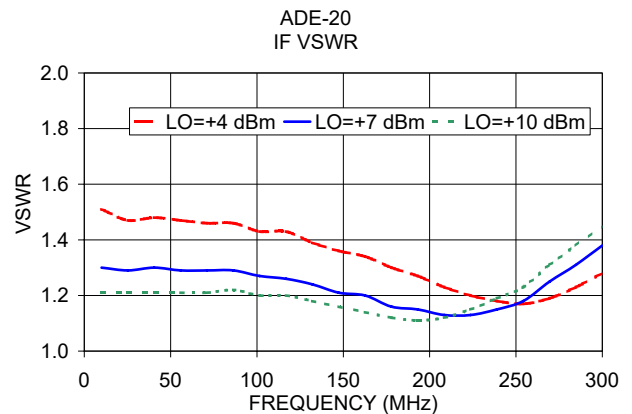
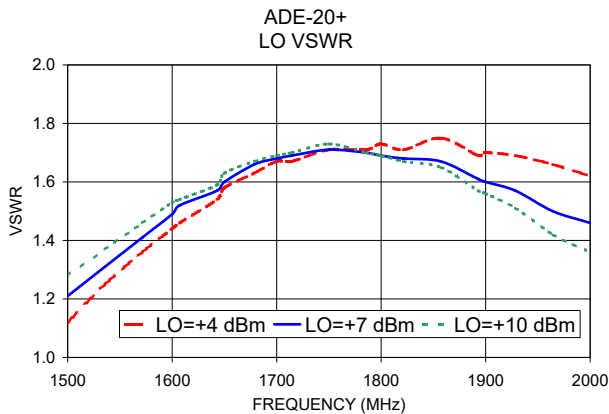
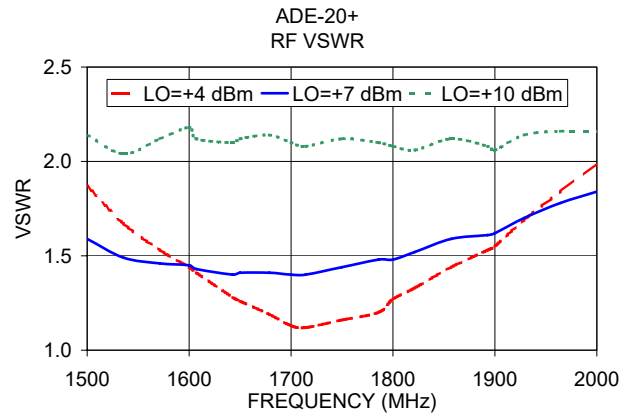
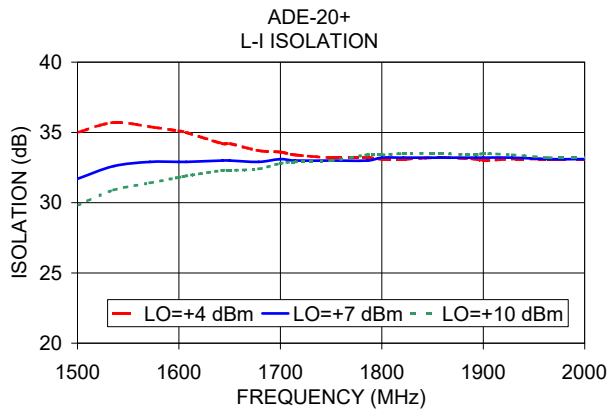
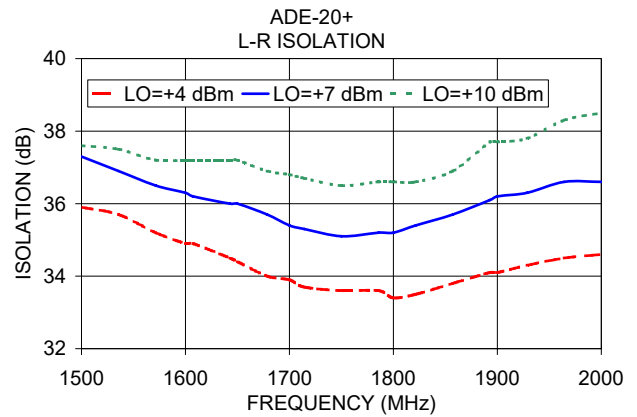
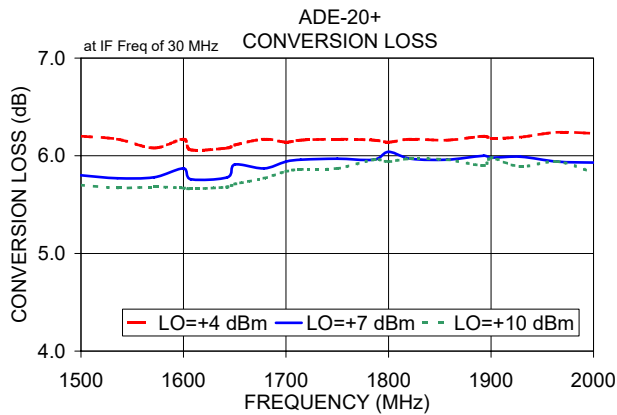

**Notes**

- A. Performance and quality attributes and conditions not expressly stated in this specification document are intended to be excluded and do not form a part of this specification document.
- B. Electrical specifications and performance data contained in this specification document are based on Mini-Circuit's applicable established test performance criteria and measurement instructions.
- C. The parts covered by this specification document are subject to Mini-Circuits standard limited warranty and terms and conditions (collectively, "Standard Terms"); Purchasers of this part are entitled to the rights and benefits contained therein. For a full statement of the Standard Terms and the exclusive rights and remedies thereunder, please visit Mini-Circuits' website at [www.minicircuits.com/MCLStore/terms.jsp](http://www.minicircuits.com/MCLStore/terms.jsp)



# Frequency Mixer

# ADE-20

## Typical Performance Data

| RF (IN) (MHz) | LO (MHz) | CONVERSION LOSS IF FIXED @IF(OUT)=30MHz (dB) |      |      | RF (IN) (MHz) | LO (MHz) | IP3 INPUT (dBm) |       |       | RF (IN) (MHz) | LO (MHz) | COMPRESSION @RF IN=+1dBm (dB) |      |       |
|---------------|----------|--|------|------|---------------|----------|-----------------|-------|-------|---------------|----------|-------------------------------|------|-------|
|               |          | @LO (dBm)                                    |      |      |               |          | @LO (dBm)       |       |       |               |          | @LO (dBm)                     |      |       |
|               |          | +4   | +7   | +10  |               |          | +4              | +7    | +10   |               |          | +4                            | +7   | +10   |
| 1500.1        | 1530.1   | 5.95   | 5.69 | 5.58 | 1500.1        | 1530.1   | 11.52           | 12.62 | 14.66 | 1500.1        | 1530.1   | 0.41                          | 0.25 | 0.16  |
| 1540.1        | 1570.1   | 6.00   | 5.73 | 5.64 | 1540.1        | 1570.1   | 12.16           | 13.25 | 13.98 | 1540.1        | 1570.1   | 0.34                          | 0.28 | 0.15  |
| 1580.1        | 1610.1   | 6.05   | 5.74 | 5.66 | 1580.1        | 1610.1   | 11.49           | 13.40 | 15.08 | 1580.1        | 1610.1   | 0.37                          | 0.28 | 0.12  |
| 1620.1        | 1650.1   | 6.11   | 5.78 | 5.67 | 1620.1        | 1650.1   | 11.58           | 13.36 | 14.97 | 1620.1        | 1650.1   | 0.29                          | 0.20 | 0.12  |
| 1660.1        | 1690.1   | 6.14   | 5.84 | 5.74 | 1660.1        | 1690.1   | 11.69           | 13.40 | 14.12 | 1660.1        | 1690.1   | 0.23                          | 0.17 | 0.15  |
| 1700.1        | 1730.1   | 6.14   | 5.86 | 5.78 | 1700.1        | 1730.1   | 11.83           | 13.37 | 13.90 | 1700.1        | 1730.1   | 0.28                          | 0.10 | 0.11  |
| 1740.1        | 1770.1   | 6.16   | 5.84 | 5.76 | 1740.1        | 1770.1   | 11.66           | 13.85 | 14.43 | 1740.1        | 1770.1   | 0.35                          | 0.20 | 0.15  |
| 1780.1        | 1810.1   | 6.13   | 5.79 | 5.72 | 1780.1        | 1810.1   | 11.97           | 13.22 | 14.73 | 1780.1        | 1810.1   | 0.26                          | 0.22 | 0.13  |
| 1820.1        | 1850.1   | 6.15   | 5.76 | 5.66 | 1820.1        | 1850.1   | 12.08           | 12.48 | 14.78 | 1820.1        | 1850.1   | 0.32                          | 0.15 | 0.17  |
| 1860.1        | 1890.1   | 6.17   | 5.74 | 5.63 | 1860.1        | 1890.1   | 12.20           | 12.79 | 13.80 | 1860.1        | 1890.1   | 0.17                          | 0.11 | 0.15  |
| 1900.1        | 1930.1   | 6.26   | 5.78 | 5.66 | 1900.1        | 1930.1   | 11.89           | 12.33 | 15.30 | 1900.1        | 1930.1   | 0.24                          | 0.12 | 0.13  |
| 1940.1        | 1970.1   | 6.23   | 5.75 | 5.63 | 1940.1        | 1970.1   | 12.68           | 12.20 | 15.13 | 1940.1        | 1970.1   | 0.33                          | 0.10 | 0.16  |
| 1980.1        | 2010.1   | 6.28   | 5.79 | 5.67 | 1980.1        | 2010.1   | 13.02           | 12.98 | 15.00 | 1980.1        | 2010.1   | 0.26                          | 0.11 | 0.14  |
| 2020.1        | 2050.1   | 6.25   | 5.77 | 5.64 | 2020.1        | 2050.1   | 13.85           | 12.67 | 15.70 | 2020.1        | 2050.1   | 0.22                          | 0.14 | 0.15  |
| 2060.1        | 2090.1   | 6.30   | 5.80 | 5.68 | 2060.1        | 2090.1   | 13.46           | 13.07 | 15.30 | 2060.1        | 2090.1   | 0.19                          | 0.08 | 0.06  |
| 2100.1        | 2130.1   | 6.28   | 5.77 | 5.64 | 2100.1        | 2130.1   | 13.68           | 13.45 | 15.09 | 2100.1        | 2130.1   | 0.31                          | 0.17 | 0.08  |
| 2140.1        | 2170.1   | 6.27   | 5.81 | 5.68 | 2140.1        | 2170.1   | 15.19           | 13.75 | 14.76 | 2140.1        | 2170.1   | 0.25                          | 0.18 | 0.13  |
| 2180.1        | 2210.1   | 6.31   | 5.79 | 5.66 | 2180.1        | 2210.1   | 14.83           | 14.33 | 15.00 | 2180.1        | 2210.1   | 0.18                          | 0.17 | 0.11  |
| 2220.1        | 2250.1   | 6.31   | 5.82 | 5.69 | 2220.1        | 2250.1   | 15.09           | 14.09 | 15.51 | 2220.1        | 2250.1   | 0.17                          | 0.12 | 0.10  |
| 2260.1        | 2290.1   | 6.35   | 5.83 | 5.71 | 2260.1        | 2290.1   | 16.36           | 15.60 | 16.01 | 2260.1        | 2290.1   | 0.25                          | 0.12 | 0.15  |
| 2300.1        | 2330.1   | 6.40   | 5.89 | 5.76 | 2300.1        | 2330.1   | 16.84           | 15.05 | 15.74 | 2300.1        | 2330.1   | 0.32                          | 0.09 | 0.09  |
| 2340.1        | 2370.1   | 6.39   | 5.93 | 5.80 | 2340.1        | 2370.1   | 16.00           | 14.76 | 17.20 | 2340.1        | 2370.1   | 0.30                          | 0.07 | 0.07  |
| 2380.1        | 2410.1   | 6.49   | 5.98 | 5.88 | 2380.1        | 2410.1   | 13.54           | 17.46 | 15.62 | 2380.1        | 2410.1   | 0.34                          | 0.12 | 0.15  |
| 2420.1        | 2450.1   | 6.48   | 5.99 | 5.90 | 2420.1        | 2450.1   | 13.05           | 17.49 | 16.21 | 2420.1        | 2450.1   | 0.36                          | 0.14 | 0.08  |
| 2460.1        | 2490.1   | 6.61   | 6.09 | 5.99 | 2460.1        | 2490.1   | 11.69           | 17.99 | 17.28 | 2460.1        | 2490.1   | 0.34                          | 0.20 | 0.16  |
| 2500.1        | 2530.1   | 6.71   | 6.18 | 6.08 | 2500.1        | 2530.1   | 11.12           | 19.99 | 19.77 | 2500.1        | 2530.1   | 0.27                          | 0.11 | 0.11  |
| 2540.1        | 2570.1   | 6.72   | 6.20 | 6.10 | 2540.1        | 2570.1   | 10.01           | 16.72 | 20.58 | 2540.1        | 2570.1   | 0.29                          | 0.22 | 0.17  |
| 2580.1        | 2610.1   | 6.88   | 6.28 | 6.15 | 2580.1        | 2610.1   | 9.25            | 16.03 | 17.72 | 2580.1        | 2610.1   | 0.27                          | 0.23 | 0.17  |
| 2620.1        | 2650.1   | 6.98   | 6.37 | 6.20 | 2620.1        | 2650.1   | 8.97            | 14.52 | 16.77 | 2620.1        | 2650.1   | 0.33                          | 0.18 | 0.08  |
| 2660.1        | 2690.1   | 7.30   | 6.52 | 6.29 | 2660.1        | 2690.1   | 9.23            | 14.56 | 18.65 | 2660.1        | 2690.1   | 0.12                          | 0.22 | 0.13  |
| 2700.1        | 2730.1   | 7.59   | 6.81 | 6.53 | 2700.1        | 2730.1   | 10.28           | 17.50 | 18.76 | 2700.1        | 2730.1   | 0.22                          | 0.14 | 0.14  |
| 2740.1        | 2770.1   | 7.91   | 7.13 | 6.84 | 2740.1        | 2770.1   | 12.13           | 31.08 | 20.13 | 2740.1        | 2770.1   | 0.08                          | 0.07 | 0.08  |
| 2780.1        | 2810.1   | 8.23   | 7.46 | 7.13 | 2780.1        | 2810.1   | 13.01           | 24.01 | 18.56 | 2780.1        | 2810.1   | 0.05                          | 0.16 | 0.04  |
| 2820.1        | 2850.1   | 8.46   | 7.76 | 7.47 | 2820.1        | 2850.1   | 14.38           | 25.58 | 18.93 | 2820.1        | 2850.1   | 0.06                          | 0.08 | 0.04  |
| 2860.1        | 2890.1   | 8.74   | 8.03 | 7.77 | 2860.1        | 2890.1   | 15.00           | 23.06 | 18.30 | 2860.1        | 2890.1   | 0.12                          | 0.07 | 0.09  |
| 2900.1        | 2930.1   | 8.98   | 8.32 | 8.06 | 2900.1        | 2930.1   | 14.96           | 20.34 | 20.45 | 2900.1        | 2930.1   | 0.13                          | 0.08 | 0.11  |
| 2940.1        | 2970.1   | 9.16   | 8.53 | 8.30 | 2940.1        | 2970.1   | 14.37           | 21.75 | 24.44 | 2940.1        | 2970.1   | 0.11                          | 0.10 | 0.06  |
| 3000.1        | 3030.1   | 9.64   | 8.97 | 8.73 | 3000.1        | 3030.1   | 13.89           | 23.73 | 22.03 | 3000.1        | 3030.1   | 0.05                          | 0.08 | -0.02 |
| 3040.1        | 3070.1   | 10.02  | 9.39 | 9.13 | 3040.1        | 3070.1   | 15.32           | 23.99 | 18.14 | 3040.1        | 3070.1   | 0.05                          | 0.09 | 0.21  |
| 3100.1        | 3130.1   | 10.43  | 9.87 | 9.66 | 3100.1        | 3130.1   | 16.85           | 23.99 | 20.86 | 3100.1        | 3130.1   | 0.16                          | 0.13 | 0.02  |



# Frequency Mixer

# ADE-20

## Typical Performance Data

| IF (OUT) (MHz) | LO (MHz) | CONVERSION LOSS VS. IF FREQUENCY @RF(IN)=1750.1MHz (dB) | IF (OUT) (MHz) | LO (MHz) | CONVERSION LOSS VS. IF FREQUENCY @RF(IN)=1500.1MHz (dB) | IF (OUT) (MHz) | LO (MHz) | CONVERSION LOSS VS. IF FREQUENCY @RF(IN)=2000.1MHz (dB) |
|----------------|----------|---|----------------|----------|---|----------------|----------|---|
|                |          | @LO (dBm)   |                |          | @LO (dBm)   |                |          | @LO (dBm)   |
|                |          | +7  |                |          | +7  |                |          | +7  |
| 250.0          | 1500.1   | 5.95  | 10.0           | 1510.1   | 5.96  | 300.0          | 1700.1   | 6.10  |
| 237.4          | 1512.7   | 5.94  | 17.3           | 1517.4   | 5.98  | 292.8          | 1707.4   | 6.08  |
| 224.7          | 1525.4   | 5.94  | 24.5           | 1524.6   | 5.79  | 285.5          | 1714.6   | 6.06  |
| 212.1          | 1538.0   | 5.93  | 31.8           | 1531.9   | 5.78  | 278.3          | 1721.9   | 6.06  |
| 199.5          | 1550.6   | 5.90  | 39.0           | 1539.1   | 5.76  | 271.0          | 1729.1   | 6.06  |
| 186.8          | 1563.3   | 5.91  | 46.3           | 1546.4   | 5.80  | 263.8          | 1736.4   | 6.06  |
| 174.2          | 1575.9   | 5.95  | 53.5           | 1553.6   | 5.73  | 256.5          | 1743.6   | 6.04  |
| 161.6          | 1588.5   | 5.95  | 60.8           | 1560.9   | 5.72  | 249.2          | 1750.9   | 6.02  |
| 148.9          | 1601.2   | 5.96  | 68.0           | 1568.1   | 5.76  | 242.0          | 1758.1   | 6.02  |
| 136.3          | 1613.8   | 5.98  | 75.3           | 1575.4   | 5.73  | 234.8          | 1765.4   | 6.02  |
| 123.7          | 1626.4   | 5.97  | 82.5           | 1582.6   | 5.69  | 227.5          | 1772.6   | 6.02  |
| 111.1          | 1639.0   | 5.96  | 89.8           | 1589.9   | 5.70  | 220.3          | 1779.9   | 6.01  |
| 98.4           | 1651.7   | 5.96  | 97.0           | 1597.1   | 5.71  | 213.0          | 1787.1   | 6.01  |
| 85.8           | 1664.3   | 5.94  | 104.3          | 1604.4   | 5.69  | 205.8          | 1794.4   | 6.01  |
| 73.2           | 1676.9   | 5.92  | 111.5          | 1611.6   | 5.67  | 198.5          | 1801.6   | 6.02  |
| 60.5           | 1689.6   | 5.89  | 118.8          | 1618.9   | 5.72  | 191.2          | 1808.9   | 6.00  |
| 47.9           | 1702.2   | 5.85  | 126.0          | 1626.1   | 5.73  | 184.0          | 1816.1   | 6.01  |
| 35.3           | 1714.8   | 5.84  | 133.3          | 1633.4   | 5.74  | 176.8          | 1823.4   | 6.03  |
| 22.6           | 1727.5   | 5.82  | 140.5          | 1640.6   | 5.75  | 169.5          | 1830.6   | 6.04  |
| 10.0           | 1740.1   | 5.85  | 147.8          | 1647.9   | 5.76  | 162.3          | 1837.9   | 6.04  |
| 10.0           | 1760.1   | 5.85  | 155.0          | 1655.1   | 5.76  | 155.0          | 1845.1   | 6.02  |
| 22.0           | 1772.1   | 5.76  | 162.3          | 1662.4   | 5.80  | 147.8          | 1852.4   | 6.04  |
| 34.0           | 1784.1   | 5.76  | 169.5          | 1669.6   | 5.79  | 140.5          | 1859.6   | 6.03  |
| 46.0           | 1796.1   | 5.77  | 176.8          | 1676.9   | 5.81  | 133.2          | 1866.9   | 6.01  |
| 58.0           | 1808.1   | 5.76  | 184.0          | 1684.1   | 5.83  | 126.0          | 1874.1   | 6.03  |
| 70.0           | 1820.1   | 5.76  | 191.3          | 1691.4   | 5.85  | 118.8          | 1881.4   | 5.99  |
| 82.0           | 1832.1   | 5.74  | 198.5          | 1698.6   | 5.87  | 111.5          | 1888.6   | 5.99  |
| 94.0           | 1844.1   | 5.76  | 205.8          | 1705.9   | 5.89  | 104.3          | 1895.9   | 6.02  |
| 106.0          | 1856.1   | 5.76  | 213.0          | 1713.1   | 5.92  | 97.0           | 1903.1   | 6.00  |
| 118.0          | 1868.1   | 5.76  | 220.3          | 1720.4   | 5.93  | 89.8           | 1910.4   | 5.94  |
| 130.0          | 1880.1   | 5.80  | 227.5          | 1727.6   | 5.97  | 82.5           | 1917.6   | 5.94  |
| 142.0          | 1892.1   | 5.82  | 234.8          | 1734.9   | 5.98  | 75.2           | 1924.9   | 5.95  |
| 154.0          | 1904.1   | 5.84  | 242.0          | 1742.1   | 6.00  | 68.0           | 1932.1   | 5.98  |
| 166.0          | 1916.1   | 5.86  | 249.3          | 1749.4   | 6.01  | 60.8           | 1939.4   | 5.94  |
| 178.0          | 1928.1   | 5.90  | 256.5          | 1756.6   | 6.02  | 53.5           | 1946.6   | 5.90  |
| 190.0          | 1940.1   | 5.91  | 263.8          | 1763.9   | 6.04  | 46.3           | 1953.9   | 5.91  |
| 202.0          | 1952.1   | 5.92  | 271.0          | 1771.1   | 6.06  | 39.0           | 1961.1   | 5.88  |
| 214.0          | 1964.1   | 5.96  | 278.3          | 1778.4   | 6.05  | 31.8           | 1968.4   | 5.90  |
| 238.0          | 1988.1   | 6.01  | 292.8          | 1792.9   | 6.08  | 17.2           | 1982.9   | 6.00  |
| 250.0          | 2000.1   | 6.02  | 300.0          | 1800.1   | 6.10  | 10.0           | 1990.1   | 5.99  |

REV. X2  
ADE-20  
100817  
Page 2 of 5



IF/RF MICROWAVE COMPONENTS • ISO 9001 ISO 14001 AS 9100 CERTIFIED • RoHS compliant  
P.O. Box 350166, Brooklyn, New York 11235-0006 (718) 934-4500 Fax (718) 332-4661



The Design Engineers Search Engine finds the model you need, Instantly • For detailed performance specs & shopping online see



## Typical Performance Data

| LO<br>(MHz) | LO-RF ISOLATION<br>(dB) |       |       | LO-IF ISOLATION<br>(dB) |       |       |
|-------------|-------------------------|-------|-------|-------------------------|-------|-------|
|             | @LO (dBm)               |       |       | @LO (dBm)               |       |       |
|             | +4                      | +7    | +10   | +4                      | +7    | +10   |
| 1500.1      | 28.86                   | 28.58 | 27.91 | 32.31                   | 28.30 | 26.09 |
| 1540.1      | 28.65                   | 28.36 | 27.53 | 34.10                   | 29.90 | 27.65 |
| 1580.1      | 28.46                   | 28.08 | 27.36 | 35.48                   | 31.37 | 29.28 |
| 1620.1      | 28.15                   | 27.52 | 26.86 | 36.62                   | 33.03 | 31.06 |
| 1660.1      | 27.98                   | 27.04 | 26.34 | 37.20                   | 34.56 | 32.94 |
| 1700.1      | 27.87                   | 26.86 | 25.95 | 37.42                   | 35.93 | 34.76 |
| 1740.1      | 27.70                   | 26.73 | 25.77 | 37.50                   | 36.76 | 36.22 |
| 1780.1      | 27.29                   | 26.50 | 25.67 | 37.60                   | 37.21 | 36.99 |
| 1820.1      | 26.92                   | 26.04 | 25.36 | 37.85                   | 37.30 | 36.99 |
| 1860.1      | 26.72                   | 25.79 | 25.11 | 37.82                   | 36.99 | 36.34 |
| 1900.1      | 26.54                   | 25.61 | 24.80 | 37.67                   | 36.39 | 35.19 |
| 1940.1      | 26.34                   | 25.55 | 24.75 | 37.49                   | 35.79 | 34.15 |
| 1980.1      | 26.13                   | 25.32 | 24.71 | 37.18                   | 34.80 | 33.15 |
| 2020.1      | 25.97                   | 25.29 | 24.74 | 37.05                   | 34.21 | 32.28 |
| 2060.1      | 25.84                   | 25.25 | 24.62 | 36.71                   | 33.40 | 31.27 |
| 2100.1      | 25.62                   | 25.20 | 24.59 | 36.57                   | 33.06 | 30.70 |
| 2140.1      | 25.57                   | 25.14 | 24.74 | 36.19                   | 32.18 | 29.96 |
| 2180.1      | 25.47                   | 25.28 | 24.97 | 35.80                   | 31.92 | 29.54 |
| 2220.1      | 25.43                   | 25.37 | 25.10 | 35.79                   | 31.55 | 29.00 |
| 2260.1      | 25.37                   | 25.44 | 25.20 | 35.12                   | 30.90 | 28.53 |
| 2300.1      | 25.42                   | 25.52 | 25.48 | 35.16                   | 30.77 | 28.37 |
| 2340.1      | 25.48                   | 25.69 | 25.67 | 34.86                   | 30.43 | 27.93 |
| 2380.1      | 25.49                   | 25.91 | 25.95 | 34.42                   | 30.21 | 27.75 |
| 2420.1      | 25.42                   | 26.05 | 26.15 | 34.41                   | 30.02 | 27.29 |
| 2460.1      | 25.55                   | 26.18 | 26.52 | 33.91                   | 29.55 | 27.07 |
| 2500.1      | 25.53                   | 26.18 | 26.71 | 34.05                   | 29.64 | 27.00 |
| 2540.1      | 25.73                   | 26.42 | 27.07 | 33.27                   | 29.30 | 26.72 |
| 2580.1      | 25.90                   | 26.46 | 27.11 | 32.87                   | 29.22 | 26.68 |
| 2620.1      | 26.30                   | 26.73 | 27.31 | 32.74                   | 29.14 | 26.47 |
| 2660.1      | 26.91                   | 27.18 | 27.63 | 32.27                   | 28.80 | 26.21 |
| 2700.1      | 27.63                   | 27.98 | 28.37 | 32.13                   | 28.69 | 26.04 |
| 2740.1      | 28.39                   | 28.84 | 29.21 | 31.64                   | 28.12 | 25.56 |
| 2780.1      | 29.22                   | 29.78 | 30.29 | 31.52                   | 27.95 | 25.49 |
| 2820.1      | 29.96                   | 30.70 | 31.28 | 31.47                   | 27.90 | 25.20 |
| 2860.1      | 30.77                   | 31.57 | 32.30 | 30.98                   | 27.61 | 25.03 |
| 2900.1      | 31.50                   | 32.23 | 33.10 | 31.10                   | 27.63 | 25.00 |
| 2940.1      | 32.38                   | 33.03 | 33.88 | 30.70                   | 27.40 | 24.75 |
| 3000.1      | 33.64                   | 34.13 | 34.78 | 30.59                   | 27.17 | 24.63 |
| 3040.1      | 34.59                   | 35.09 | 35.69 | 30.21                   | 26.97 | 24.48 |
| 3100.1      | 35.80                   | 36.59 | 37.04 | 29.93                   | 26.72 | 24.12 |

| RF<br>(IN)<br>(MHz) | LO<br>(MHz) | RF-IF ISOLATION<br>(dB) |       |       |
|---------------------|-------------|-------------------------|-------|-------|
|                     |             | @LO (dBm)               |       |       |
|                     |             | +4                      | +7    | +10   |
| 1500.1              | 1530.1      | 8.95                    | 8.48  | 8.21  |
| 1540.1              | 1570.1      | 9.12                    | 8.65  | 8.39  |
| 1580.1              | 1610.1      | 9.17                    | 8.78  | 8.55  |
| 1620.1              | 1650.1      | 9.29                    | 8.94  | 8.72  |
| 1660.1              | 1690.1      | 9.38                    | 9.03  | 8.86  |
| 1700.1              | 1730.1      | 9.51                    | 9.16  | 8.97  |
| 1740.1              | 1770.1      | 9.77                    | 9.40  | 9.20  |
| 1780.1              | 1810.1      | 9.92                    | 9.66  | 9.50  |
| 1820.1              | 1850.1      | 10.04                   | 9.88  | 9.76  |
| 1860.1              | 1890.1      | 10.24                   | 10.13 | 10.04 |
| 1900.1              | 1930.1      | 10.27                   | 10.27 | 10.21 |
| 1940.1              | 1970.1      | 10.44                   | 10.49 | 10.49 |
| 1980.1              | 2010.1      | 10.74                   | 10.85 | 10.89 |
| 2020.1              | 2050.1      | 11.09                   | 11.28 | 11.33 |
| 2060.1              | 2090.1      | 11.40                   | 11.62 | 11.76 |
| 2100.1              | 2130.1      | 11.74                   | 12.05 | 12.22 |
| 2140.1              | 2170.1      | 12.12                   | 12.49 | 12.73 |
| 2180.1              | 2210.1      | 12.53                   | 12.98 | 13.31 |
| 2220.1              | 2250.1      | 12.84                   | 13.38 | 13.74 |
| 2260.1              | 2290.1      | 13.26                   | 13.93 | 14.36 |
| 2300.1              | 2330.1      | 13.78                   | 14.55 | 15.00 |
| 2340.1              | 2370.1      | 14.30                   | 15.17 | 15.67 |
| 2380.1              | 2410.1      | 14.80                   | 15.79 | 16.41 |
| 2420.1              | 2450.1      | 15.37                   | 16.46 | 17.12 |
| 2460.1              | 2490.1      | 16.01                   | 17.13 | 17.84 |
| 2500.1              | 2530.1      | 16.65                   | 17.82 | 18.60 |
| 2540.1              | 2570.1      | 17.42                   | 18.52 | 19.25 |
| 2580.1              | 2610.1      | 18.12                   | 19.24 | 19.96 |
| 2620.1              | 2650.1      | 18.98                   | 20.01 | 20.67 |
| 2660.1              | 2690.1      | 19.81                   | 20.72 | 21.31 |
| 2700.1              | 2730.1      | 20.86                   | 21.66 | 22.12 |
| 2740.1              | 2770.1      | 22.08                   | 22.64 | 22.99 |
| 2780.1              | 2810.1      | 23.30                   | 23.72 | 23.91 |
| 2820.1              | 2850.1      | 24.28                   | 24.43 | 24.43 |
| 2860.1              | 2890.1      | 25.24                   | 24.99 | 24.84 |
| 2900.1              | 2930.1      | 25.76                   | 25.30 | 24.93 |
| 2940.1              | 2970.1      | 26.00                   | 25.27 | 24.81 |
| 3000.1              | 3030.1      | 25.91                   | 25.11 | 24.59 |
| 3040.1              | 3070.1      | 25.48                   | 24.69 | 24.22 |
| 3100.1              | 3130.1      | 24.90                   | 24.19 | 23.66 |

# Frequency Mixer

ADE-20

## Typical Performance Data

| RF (IN) (MHz) | LO (MHz) | RF VSWR (:1) |      |      |
|---------------|----------|--------------|------|------|
|               |          | @LO (dBm)    |      |      |
|               |          | +4           | +7   | +10  |
| 1500.1        | 1530.1   | 1.33         | 1.45 | 1.54 |
| 1540.1        | 1570.1   | 1.38         | 1.47 | 1.56 |
| 1580.1        | 1610.1   | 1.46         | 1.55 | 1.63 |
| 1620.1        | 1650.1   | 1.49         | 1.57 | 1.63 |
| 1660.1        | 1690.1   | 1.56         | 1.66 | 1.73 |
| 1700.1        | 1730.1   | 1.55         | 1.66 | 1.74 |
| 1740.1        | 1770.1   | 1.62         | 1.74 | 1.84 |
| 1780.1        | 1810.1   | 1.66         | 1.74 | 1.83 |
| 1820.1        | 1850.1   | 1.76         | 1.84 | 1.93 |
| 1860.1        | 1890.1   | 1.84         | 1.88 | 1.94 |
| 1900.1        | 1930.1   | 1.90         | 1.94 | 2.01 |
| 1940.1        | 1970.1   | 1.93         | 1.93 | 1.98 |
| 1980.1        | 2010.1   | 1.91         | 1.91 | 1.96 |
| 2020.1        | 2050.1   | 1.92         | 1.91 | 1.95 |
| 2060.1        | 2090.1   | 1.83         | 1.83 | 1.89 |
| 2100.1        | 2130.1   | 1.90         | 1.91 | 1.98 |
| 2140.1        | 2170.1   | 1.83         | 1.85 | 1.92 |
| 2180.1        | 2210.1   | 1.92         | 1.95 | 2.04 |
| 2220.1        | 2250.1   | 1.88         | 1.91 | 1.98 |
| 2260.1        | 2290.1   | 1.94         | 1.97 | 2.05 |
| 2300.1        | 2330.1   | 1.84         | 1.85 | 1.93 |
| 2340.1        | 2370.1   | 1.82         | 1.86 | 1.95 |
| 2380.1        | 2410.1   | 1.75         | 1.77 | 1.87 |
| 2420.1        | 2450.1   | 1.77         | 1.83 | 1.95 |
| 2460.1        | 2490.1   | 1.77         | 1.83 | 1.95 |
| 2500.1        | 2530.1   | 1.87         | 1.95 | 2.10 |
| 2540.1        | 2570.1   | 1.94         | 2.01 | 2.15 |
| 2580.1        | 2610.1   | 2.08         | 2.13 | 2.26 |
| 2620.1        | 2650.1   | 2.18         | 2.18 | 2.27 |
| 2660.1        | 2690.1   | 2.35         | 2.31 | 2.39 |
| 2700.1        | 2730.1   | 2.54         | 2.46 | 2.49 |
| 2740.1        | 2770.1   | 2.81         | 2.77 | 2.80 |
| 2780.1        | 2810.1   | 3.13         | 3.09 | 3.12 |
| 2820.1        | 2850.1   | 3.47         | 3.47 | 3.53 |
| 2860.1        | 2890.1   | 3.97         | 3.96 | 4.03 |
| 2900.1        | 2930.1   | 4.44         | 4.44 | 4.54 |
| 2940.1        | 2970.1   | 5.03         | 5.00 | 5.09 |
| 3000.1        | 3030.1   | 5.89         | 5.85 | 5.93 |
| 3040.1        | 3070.1   | 6.11         | 6.05 | 6.07 |
| 3100.1        | 3130.1   | 7.08         | 7.20 | 7.28 |

| LO (MHz) | LO VSWR (:1) |      |      |
|----------|--------------|------|------|
|          | @LO (dBm)    |      |      |
|          | +4           | +7   | +10  |
| 1500.1   | 1.91         | 1.17 | 1.50 |
| 1540.1   | 1.95         | 1.21 | 1.54 |
| 1580.1   | 1.97         | 1.25 | 1.53 |
| 1620.1   | 2.00         | 1.28 | 1.54 |
| 1660.1   | 2.04         | 1.33 | 1.56 |
| 1700.1   | 2.06         | 1.36 | 1.56 |
| 1740.1   | 2.12         | 1.39 | 1.59 |
| 1780.1   | 2.14         | 1.42 | 1.58 |
| 1820.1   | 2.20         | 1.45 | 1.59 |
| 1860.1   | 2.24         | 1.49 | 1.60 |
| 1900.1   | 2.29         | 1.52 | 1.59 |
| 1940.1   | 2.36         | 1.57 | 1.63 |
| 1980.1   | 2.37         | 1.61 | 1.62 |
| 2020.1   | 2.47         | 1.65 | 1.65 |
| 2060.1   | 2.48         | 1.68 | 1.67 |
| 2100.1   | 2.55         | 1.71 | 1.66 |
| 2140.1   | 2.62         | 1.75 | 1.70 |
| 2180.1   | 2.65         | 1.78 | 1.68 |
| 2220.1   | 2.77         | 1.81 | 1.70 |
| 2260.1   | 2.76         | 1.83 | 1.71 |
| 2300.1   | 2.89         | 1.87 | 1.70 |
| 2340.1   | 2.94         | 1.90 | 1.73 |
| 2380.1   | 2.98         | 1.92 | 1.71 |
| 2420.1   | 3.14         | 1.96 | 1.73 |
| 2460.1   | 3.14         | 1.99 | 1.72 |
| 2500.1   | 3.33         | 2.03 | 1.69 |
| 2540.1   | 3.35         | 2.04 | 1.71 |
| 2580.1   | 3.43         | 2.07 | 1.68 |
| 2620.1   | 3.57         | 2.09 | 1.66 |
| 2660.1   | 3.56         | 2.10 | 1.64 |
| 2700.1   | 3.78         | 2.15 | 1.62 |
| 2740.1   | 3.77         | 2.15 | 1.60 |
| 2780.1   | 3.86         | 2.17 | 1.58 |
| 2820.1   | 4.05         | 2.21 | 1.56 |
| 2860.1   | 3.96         | 2.18 | 1.52 |
| 2900.1   | 4.16         | 2.22 | 1.49 |
| 2940.1   | 4.12         | 2.20 | 1.46 |
| 3000.1   | 4.30         | 2.21 | 1.40 |
| 3040.1   | 4.19         | 2.18 | 1.37 |
| 3100.1   | 4.39         | 2.21 | 1.34 |

| IF (OUT) (MHz) | IF VSWR @LO=2000.1MHz (:1) |      |      |
|----------------|----------------------------|------|------|
|                | @LO (dBm)                  |      |      |
|                | +4                         | +7   | +10  |
| 10.1           | 1.64                       | 1.26 | 1.22 |
| 17.4           | 1.97                       | 1.48 | 1.14 |
| 24.6           | 1.78                       | 1.37 | 1.20 |
| 31.9           | 1.75                       | 1.34 | 1.19 |
| 39.1           | 1.59                       | 1.28 | 1.19 |
| 46.4           | 1.56                       | 1.26 | 1.13 |
| 53.6           | 1.56                       | 1.24 | 1.17 |
| 60.9           | 1.53                       | 1.25 | 1.16 |
| 68.1           | 1.52                       | 1.25 | 1.15 |
| 75.4           | 1.54                       | 1.24 | 1.14 |
| 82.6           | 1.56                       | 1.26 | 1.14 |
| 89.9           | 1.57                       | 1.28 | 1.16 |
| 97.1           | 1.60                       | 1.30 | 1.20 |
| 104.4          | 1.63                       | 1.33 | 1.23 |
| 111.6          | 1.66                       | 1.35 | 1.26 |
| 118.9          | 1.65                       | 1.38 | 1.29 |
| 126.1          | 1.66                       | 1.38 | 1.29 |
| 133.4          | 1.65                       | 1.38 | 1.29 |
| 140.6          | 1.63                       | 1.38 | 1.31 |
| 147.9          | 1.61                       | 1.37 | 1.32 |
| 155.1          | 1.61                       | 1.40 | 1.34 |
| 162.4          | 1.60                       | 1.38 | 1.32 |
| 169.6          | 1.60                       | 1.38 | 1.33 |
| 176.9          | 1.61                       | 1.39 | 1.34 |
| 184.1          | 1.62                       | 1.41 | 1.36 |
| 191.4          | 1.62                       | 1.43 | 1.36 |
| 198.6          | 1.62                       | 1.42 | 1.39 |
| 205.9          | 1.63                       | 1.43 | 1.40 |
| 213.1          | 1.64                       | 1.44 | 1.42 |
| 220.4          | 1.63                       | 1.45 | 1.43 |
| 227.6          | 1.61                       | 1.45 | 1.43 |
| 234.9          | 1.60                       | 1.44 | 1.44 |
| 242.1          | 1.60                       | 1.46 | 1.45 |
| 249.4          | 1.58                       | 1.46 | 1.45 |
| 256.6          | 1.58                       | 1.45 | 1.46 |
| 263.9          | 1.58                       | 1.44 | 1.45 |
| 271.1          | 1.58                       | 1.45 | 1.46 |
| 278.4          | 1.56                       | 1.44 | 1.46 |
| 292.9          | 1.56                       | 1.46 | 1.49 |
| 300.1          | 1.57                       | 1.46 | 1.49 |

REV. X2  
ADE-20  
100817  
Page 4 of 5



IF/RF MICROWAVE COMPONENTS • ISO 9001 ISO 14001 AS 9100 CERTIFIED • RoHS compliant  
P.O. Box 350166, Brooklyn, New York 11235-0066 (718) 934-4500 Fax (718) 332-4661



The Design Engineers Search Engine finds the model you need, Instantly • For detailed performance specs & shopping online see



## Harmonics Tables

RF HARMONICS ORDER

|    | (-dBm) | (-dBc) |     |     |     |     |     |     |     |     |     |     |
|----|--------|--------|-----|-----|-----|-----|-----|-----|-----|-----|-----|-----|
| 0  | -      | -      | 12  | 24  | 13  | 25  | 27  | 34  | 35  | 42  | 38  | 47  |
| 1  | -      | 3      | +0  | 39  | 37  | 32  | 40  | 38  | 38  | 43  | 45  | 57  |
| 2  | 100    | 77     | 75  | 68  | 72  | 72  | 63  | 64  | 64  | 66  | 61  | 70  |
| 3  | 114    | 74     | 83  | 77  | 63  | 78  | 88  | 76  | 79  | 79  | 75  | 79  |
| 4  | 107    | 107    | 99  | 108 | 104 | 84  | 104 | 103 | 95  | 97  | 98  | 96  |
| 5  | 112    | 107    | 110 | 110 | 105 | 111 | 91  | 102 | 102 | 111 | 101 | 108 |
| 6  | 115    | 98     | 102 | 97  | 101 | 102 | 115 | 88  | 107 | 106 | 115 | 108 |
| 7  | 108    | 106    | 104 | 102 | 102 | 107 | 118 | 103 | 95  | 104 | 126 | 109 |
| 8  | 109    | 100    | 112 | 111 | 102 | 99  | 106 | 103 | 109 | 87  | 115 | 101 |
| 9  | 122    | 108    | 92  | 99  | 107 | 103 | 105 | 104 | 104 | 103 | 89  | 109 |
| 10 | 108    | 92     | 105 | 97  | 100 | 108 | 107 | 99  | 115 | 100 | 105 | 94  |
|    | RF CAL | 0      | 1   | 2   | 3   | 4   | 5   | 6   | 7   | 8   | 9   | 10  |

### LO HARMONICS ORDER

Test conditions: RF IN: 1750.1 MHz; -14.00 dBm.  
 LO IN: 1780.01 MHz; +7.00 dBm  
 IF OUT: 29.91 MHz; -20 dBm

RF HARMONICS ORDER

|    | (-dBm) | (-dBc) |     |     |     |     |     |     |     |     |     |     |
|----|--------|--------|-----|-----|-----|-----|-----|-----|-----|-----|-----|-----|
| 0  | -      | -      | 22  | 34  | 23  | 36  | 38  | 47  | 54  | 61  | 57  | 65  |
| 1  | -      | 3      | +0  | 39  | 38  | 34  | 41  | 39  | 41  | 46  | 50  | 62  |
| 2  | 80     | 69     | 65  | 58  | 64  | 64  | 53  | 56  | 54  | 59  | 56  | 65  |
| 3  | 118    | 56     | 69  | 59  | 45  | 61  | 71  | 58  | 63  | 60  | 57  | 62  |
| 4  | 123    | 81     | 81  | 87  | 97  | 77  | 82  | 82  | 75  | 73  | 72  | 75  |
| 5  | 108    | 98     | 87  | 85  | 84  | 82  | 70  | 83  | 90  | 81  | 81  | 83  |
| 6  | 112    | 99     | 112 | 101 | 100 | 112 | 108 | 86  | 101 | 101 | 90  | 90  |
| 7  | 106    | 100    | 128 | 127 | 102 | 101 | 101 | 99  | 88  | 104 | 105 | 100 |
| 8  | 106    | 113    | 121 | 108 | 110 | 109 | 113 | 117 | 111 | 98  | 115 | 114 |
| 9  | 110    | 111    | 114 | 103 | 121 | 107 | 113 | 109 | 115 | 111 | 103 | 126 |
| 10 | 114    | 110    | 110 | 103 | 119 | 111 | 118 | 107 | 122 | 122 | 120 | 105 |
|    | RF CAL | 0      | 1   | 2   | 3   | 4   | 5   | 6   | 7   | 8   | 9   | 10  |

### LO HARMONICS ORDER

Test conditions: RF IN: 1750.1 MHz; -4.00 dBm.  
 LO IN: 1780.01 MHz; +7.00 dBm  
 IF OUT: 29.91 MHz; -10.09 dBm

- Notes: 1. All Harmonics are in (dBc) relative to IF OUTPUT.  
 2. + entry denotes harmonics are in (dBc) above IF OUTPUT.  
 3. RF Cal represent the Harmonics level of the RF input signal to the mixer.

REV. X2  
 ADE-20  
 100817

Page 5 of 5



IF/RF MICROWAVE COMPONENTS • ISO 9001 ISO 14001 AS 9100 CERTIFIED • RoHS compliant  
 P.O. Box 350166, Brooklyn, New York 11235-0006 (718) 934-4500 Fax (718) 332-4661



The Design Engineers Search Engine finds the model you need, Instantly • For detailed performance specs & shopping online see



## Typical Performance Curves

Conversion Loss @ IF=30MHz

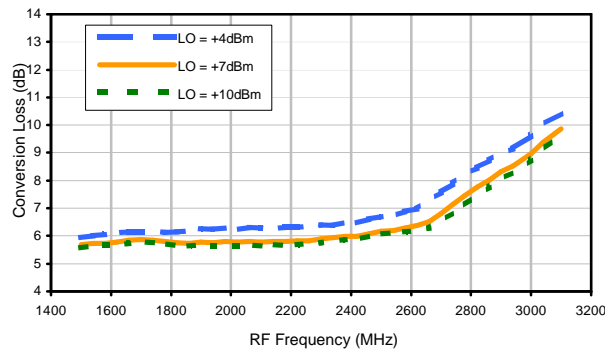

Conversion Loss vs. LO @ RF=1750.1MHz

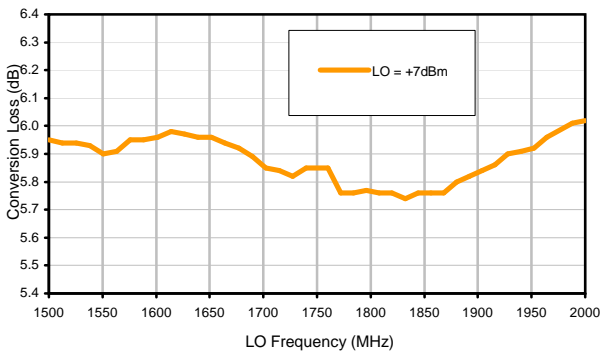

Conversion Loss vs. IF @ RF=1750.1MHz

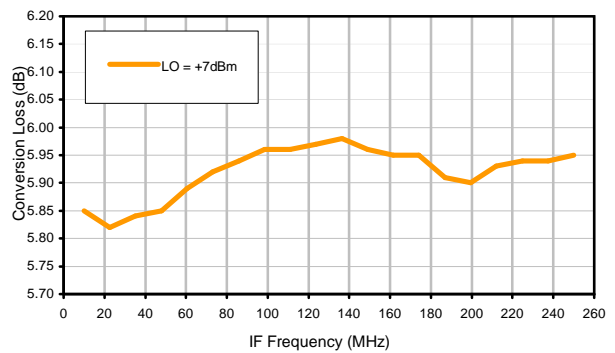

Conversion Loss vs. IF @ RF=1500.1MHz

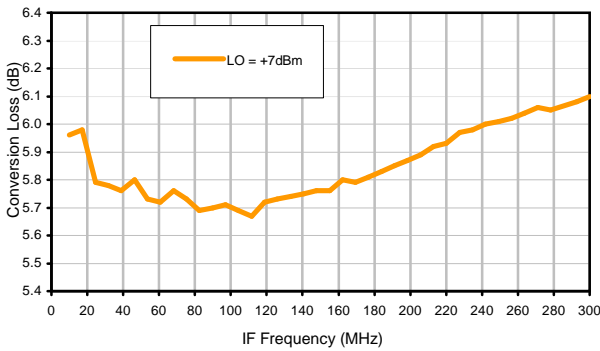

Conversion Loss vs. IF @ RF=2000.1MHz

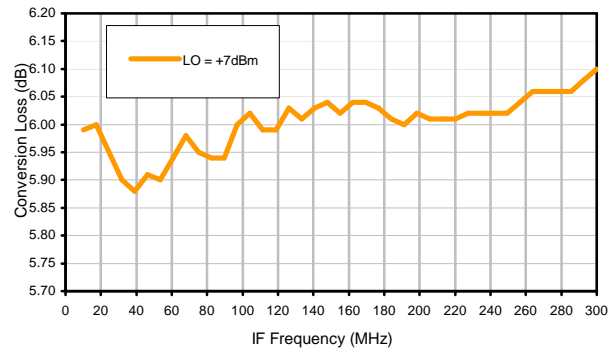

IP3 Input

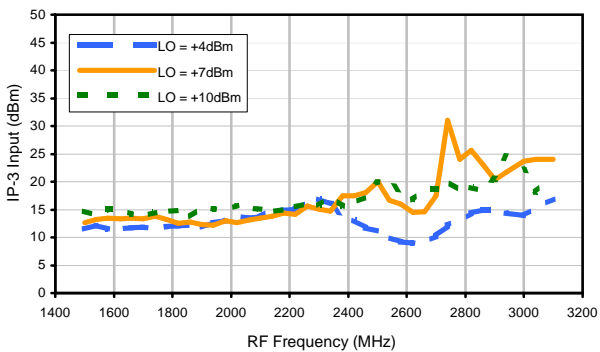

Compression @ RF IN=+1dBm

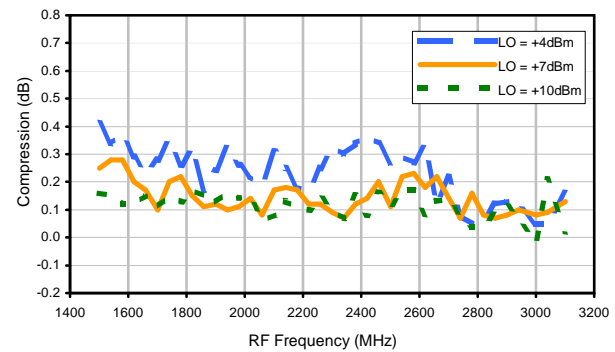

## Typical Performance Curves

LO-RF Isolation

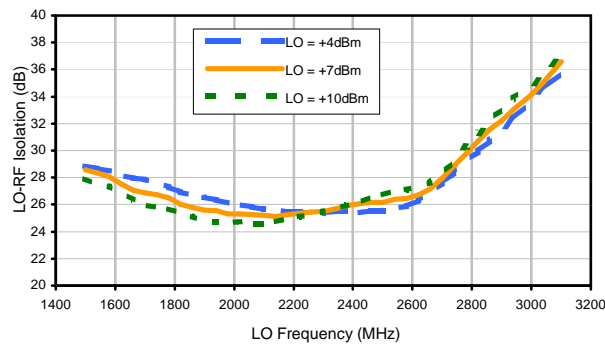

LO-IF Isolation

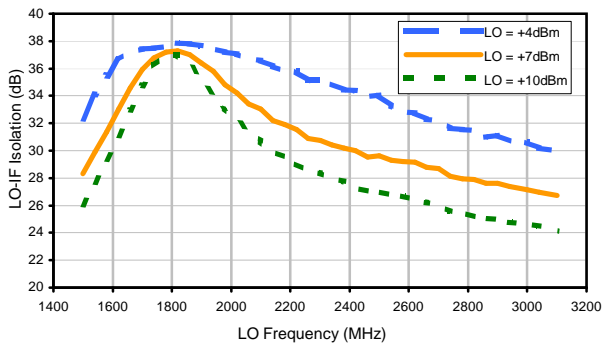

RF-IF Isolation

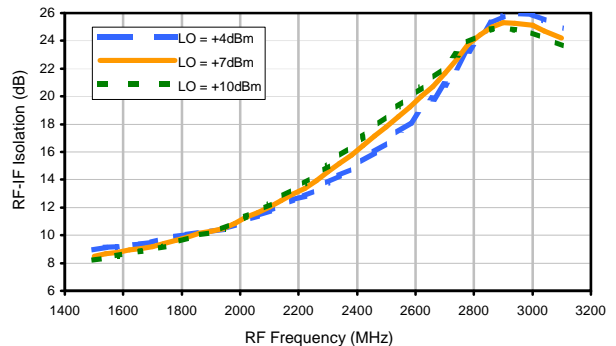

RF VSWR

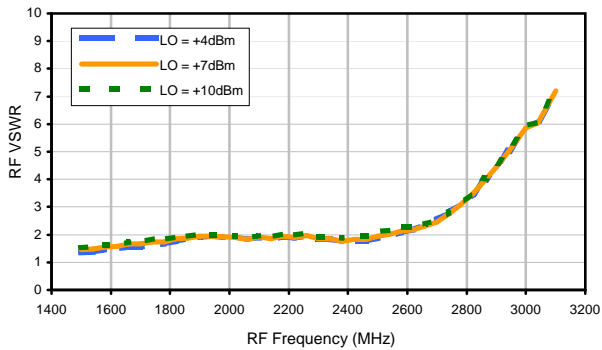

LO VSWR

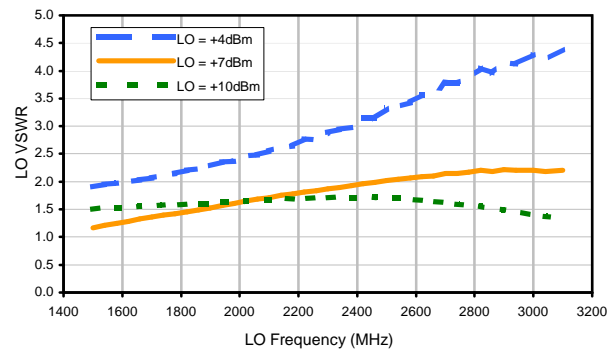

IF VSWR

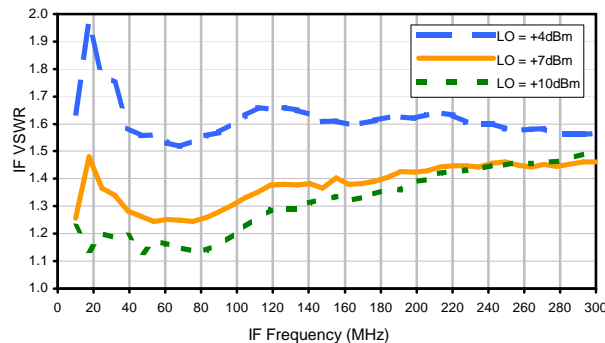

## Harmonics Tables

RF HARMONICS ORDER

|    | (-dBm) | (-dBc) |     |     |     |     |     |     |     |     |     |     |
|----|--------|--------|-----|-----|-----|-----|-----|-----|-----|-----|-----|-----|
| 0  | -      | -      | 12  | 24  | 13  | 25  | 27  | 34  | 35  | 42  | 38  | 47  |
| 1  | -      | 3      | +0  | 39  | 37  | 32  | 40  | 38  | 38  | 43  | 45  | 57  |
| 2  | 100    | 77     | 75  | 68  | 72  | 72  | 63  | 64  | 64  | 66  | 61  | 70  |
| 3  | 114    | 74     | 83  | 77  | 63  | 78  | 88  | 76  | 79  | 79  | 75  | 79  |
| 4  | 107    | 107    | 99  | 108 | 104 | 84  | 104 | 103 | 95  | 97  | 98  | 96  |
| 5  | 112    | 107    | 110 | 110 | 105 | 111 | 91  | 102 | 102 | 111 | 101 | 108 |
| 6  | 115    | 98     | 102 | 97  | 101 | 102 | 115 | 88  | 107 | 106 | 115 | 108 |
| 7  | 108    | 106    | 104 | 102 | 102 | 107 | 118 | 103 | 95  | 104 | 126 | 109 |
| 8  | 109    | 100    | 112 | 111 | 102 | 99  | 106 | 103 | 109 | 87  | 115 | 101 |
| 9  | 122    | 108    | 92  | 99  | 107 | 103 | 105 | 104 | 104 | 103 | 89  | 109 |
| 10 | 108    | 92     | 105 | 97  | 100 | 108 | 107 | 99  | 115 | 100 | 105 | 94  |
|    | RF CAL | 0      | 1   | 2   | 3   | 4   | 5   | 6   | 7   | 8   | 9   | 10  |

### LO HARMONICS ORDER

Test conditions: RF IN: 1750.1 MHz; -14.00 dBm.  
 LO IN: 1780.01 MHz; +7.00 dBm  
 IF OUT: 29.91 MHz; -20 dBm

RF HARMONICS ORDER

|    | (-dBm) | (-dBc) |     |     |     |     |     |     |     |     |     |     |
|----|--------|--------|-----|-----|-----|-----|-----|-----|-----|-----|-----|-----|
| 0  | -      | -      | 22  | 34  | 23  | 36  | 38  | 47  | 54  | 61  | 57  | 65  |
| 1  | -      | 3      | +0  | 39  | 38  | 34  | 41  | 39  | 41  | 46  | 50  | 62  |
| 2  | 80     | 69     | 65  | 58  | 64  | 64  | 53  | 56  | 54  | 59  | 56  | 65  |
| 3  | 118    | 56     | 69  | 59  | 45  | 61  | 71  | 58  | 63  | 60  | 57  | 62  |
| 4  | 123    | 81     | 81  | 87  | 97  | 77  | 82  | 82  | 75  | 73  | 72  | 75  |
| 5  | 108    | 98     | 87  | 85  | 84  | 82  | 70  | 83  | 90  | 81  | 81  | 83  |
| 6  | 112    | 99     | 112 | 101 | 100 | 112 | 108 | 86  | 101 | 101 | 90  | 90  |
| 7  | 106    | 100    | 128 | 127 | 102 | 101 | 101 | 99  | 88  | 104 | 105 | 100 |
| 8  | 106    | 113    | 121 | 108 | 110 | 109 | 113 | 117 | 111 | 98  | 115 | 114 |
| 9  | 110    | 111    | 114 | 103 | 121 | 107 | 113 | 109 | 115 | 111 | 103 | 126 |
| 10 | 114    | 110    | 110 | 103 | 119 | 111 | 118 | 107 | 122 | 122 | 120 | 105 |
|    | RF CAL | 0      | 1   | 2   | 3   | 4   | 5   | 6   | 7   | 8   | 9   | 10  |

### LO HARMONICS ORDER

Test conditions: RF IN: 1750.1 MHz; -4.00 dBm.  
 LO IN: 1780.01 MHz; +7.00 dBm  
 IF OUT: 29.91 MHz; -10.09 dBm

- Notes: 1. All Harmonics are in (dBc) relative to IF OUTPUT.  
 2. + entry denotes harmonics are in (dBc) above IF OUTPUT.  
 3. RF Cal represent the Harmonics level of the RF input signal to the mixer.

REV. X2  
 ADE-20  
 100817

Page 3 of 3



IF/RF MICROWAVE COMPONENTS • ISO 9001 ISO 14001 AS 9100 CERTIFIED • RoHS compliant  
 P.O. Box 350166, Brooklyn, New York 11235-0006 (718) 934-4500 Fax (718) 332-4661



The Design Engineers Search Engine finds the model you need, Instantly • For detailed performance specs & shopping online see [minicircuits.com](http://minicircuits.com)

# Case Style

# CD

CD541  
CD542  
CD636  
CD637

## Outline Dimensions



## PCB Land Pattern



Suggested Layout,  
Tolerance to be within  $\pm .002$

| CASE# | A              | B              | C              | D              | E              | F              | G              | H              | J              | K              | L              | WT, GRAM |
|-------|----------------|----------------|----------------|----------------|----------------|----------------|----------------|----------------|----------------|----------------|----------------|----------|
| CD541 |                |                |                |                | .082<br>(2.08) |                |                |                |                |                |                | .15      |
| CD542 | .272<br>(6.91) | .310<br>(7.87) | .220<br>(5.58) | .100<br>(2.54) | .112<br>(2.84) | .055<br>(1.40) | .100<br>(2.54) | .030<br>(0.76) | .026<br>(0.66) | .065<br>(1.65) | .300<br>(7.62) | .20      |
| CD636 |                |                |                |                | .162<br>(4.11) |                |                |                |                |                |                | .25      |
| CD637 |                |                |                |                | .206<br>(5.23) |                |                |                |                |                |                | .40      |

Dimensions are in inches (mm). Tolerances: 2 Pl.  $\pm .01$ ; 3 Pl.  $\pm .005$

### Notes:

- Case material: Plastic.
- Termination finish:
  - For RoHS Case Styles: Tin plate over Nickel plate. All models, (+) suffix.
  - For RoHS-5 Case Styles: Tin-Lead plate. All models, no (+) suffix.

**Mini-Circuits**<sup>®</sup>

INTERNET <http://www.minicircuits.com>

P.O. Box 350166, Brooklyn, New York 11235-0003 (718) 934-4500 Fax (718) 332-4661

Distribution Centers NORTH AMERICA 800-654-7949 • 417-335-5935 • Fax 417-335-5945 • EUROPE 44-1252-832600 • Fax 44-1252-837010

Mini-Circuits ISO 9001 & ISO 14001 Certified

# Tape & Reel Packaging TR-F34



| Tape Width, mm | Device Cavity Pitch, mm | Reel Size, inches | Devices per Reel see note          |      |
|----------------|-------------------------|-------------------|------------------------------------|------|
| 16             | 12                      | 7                 | Small quantity standard (see note) | 20   |
|                |                         |                   |                                    | 50   |
|                |                         |                   |                                    | 100  |
|                |                         |                   |                                    | 200  |
|                |                         | 13                | Standard                           | 500  |
|                |                         |                   |                                    | 1000 |

Note: Availability of small reel quantity varies by model.  
Refer to pricing and availability on individual model dashboard.

Mini-Circuits carrier tape materials provide protection from ESD (Electro-Static Discharge) during handling and transportation. Tapes are static dissipative and comply with industry standards EIA-481/EIA-541.

Go to: [www.minicircuits.com/pages/pdfs/tape.pdf](http://www.minicircuits.com/pages/pdfs/tape.pdf)



INTERNET <http://www.minicircuits.com>

P.O. Box 350166, Brooklyn, New York 11235-0003 (718) 934-4500 Fax (718) 332-4661

Distribution Centers NORTH AMERICA 800-654-7949 • 417-335-5935 • Fax 417-335-5945 • EUROPE 44-1252-832600 • Fax 44-1252-837010

Mini-Circuits ISO 9001 & ISO 14001 Certified

THIRD ANGLE PROJECTION





REVISIONS

| REV | ECN No. | DESCRIPTION                    | DATE     | DR  | AUTH |
|-----|---------|--------------------------------|----------|-----|------|
| OR  | M82272  | NEW RELEASE                    | 08/05/02 | MMG | DJ   |
| A   | M102713 | ADDED NOTE 2 & "...WITH SMOBC" | 01/17/06 | MMG | IL   |
|     |         |                                |          |     |      |

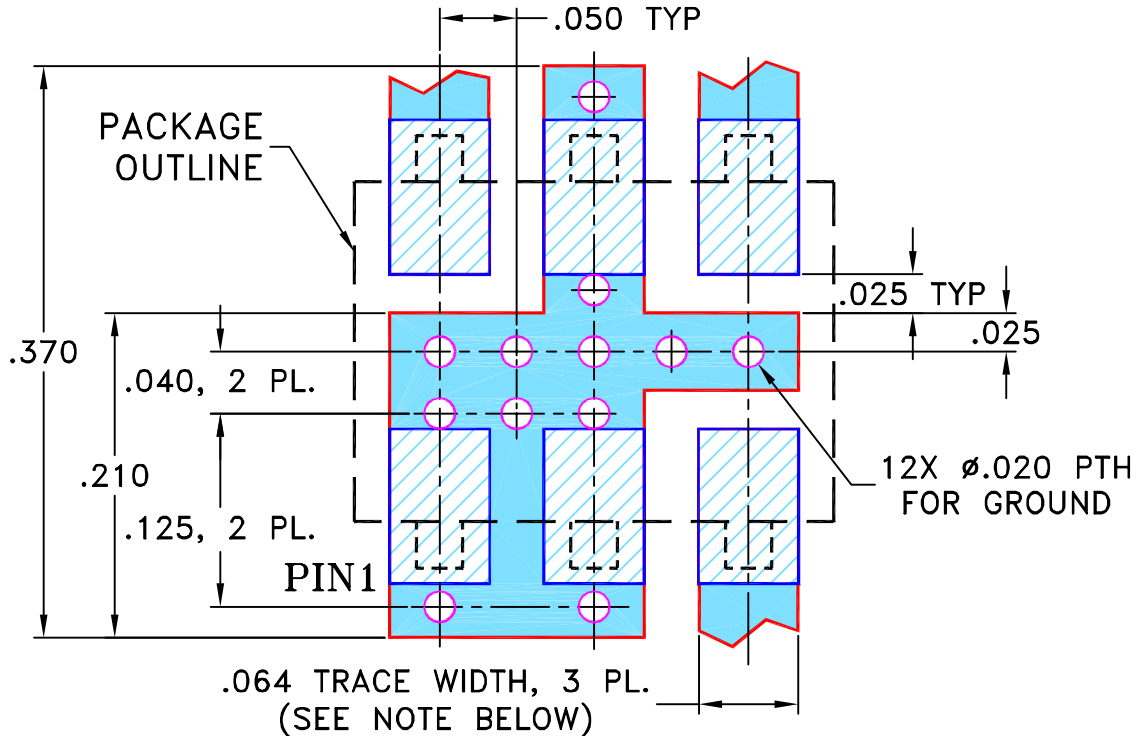
SUGGESTED MOUNTING CONFIGURATION  
FOR CD541/542/636/637 CASE STYLES,  
"jv", "ju", "jw" PIN CONNECTIONS



- NOTES:** 1. TRACE WIDTH IS SHOWN FOR ROGERS R04350B WITH DIELECTRIC THICKNESS .030" ± .002"; COPPER: 1/2 OZ. EACH SIDE. FOR OTHER MATERIALS TRACE WIDTH MAY NEED TO BE MODIFIED.  
 2. BOTTOM SIDE OF THE PCB IS CONTINUOUS GROUND PLANE.

-  DENOTES PCB COPPER LAYOUT WITH SMOBC (SOLDER MASK OVER BARE COPPER)  
 DENOTES COPPER LAND PATTERN FREE OF SOLDER MASK

| UNLESS OTHERWISE SPECIFIED | INITIALS           | DATE     |
|----------------------------|--------------------|----------|
| DIMENSIONS ARE IN INCHES   | DRAWN <b>MMG</b>   | 07/17/02 |
| TOLERANCES ON:             | CHECKED <b>WL</b>  | 08/02/02 |
| 2 PL DECIMALS ±            | APPROVED <b>DJ</b> | 08/05/02 |
| 3 PL DECIMALS ± .005       |                    |          |
| ANGLES ±                   |                    |          |
| FRACTIONS ±                |                    |          |

 **Mini-Circuits®** 13 Neptune Avenue  
 Brooklyn NY 11235

PL, jv/ju/jw, CD541/542/636/637, ADE, TB-02

|                  |                     |                          |           |
|------------------|---------------------|--------------------------|-----------|
| SIZE<br>A        | CODE IDENT<br>15542 | DRAWING NO:<br>98-PL-051 | REV:<br>A |
| FILE:<br>98PL051 | SCALE:<br>8:1       | SHEET:<br>1 OF 1         |           |

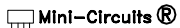
 Mini-Circuits®  
 THIS DOCUMENT AND ITS CONTENTS ARE THE PROPERTY OF MINI-CIRCUITS. EXCEPT FOR USE EXPRESSLY GRANTED, IN WRITING, TO ITS VENDORS, VENDEE AND THE UNITED STATES GOVERNMENT, MINI-CIRCUITS RESERVES ALL PROPRIETARY DESIGN, USE, MANUFACTURING AND REPRODUCTION RIGHTS THERETO. THESE CONTENTS SHALL NOT BE USED, DUPLICATED OR DISCLOSED TO ANY OUTSIDE PARTY, IN WHOLE OR IN PART, WITHOUT WRITTEN PERMISSION OF MINI-CIRCUITS.

ASHEETA1.DWG REV:A DATE:01/12/95

# Evaluation Board and Circuit

For Pin Connections refer to Data Sheet of the DUT

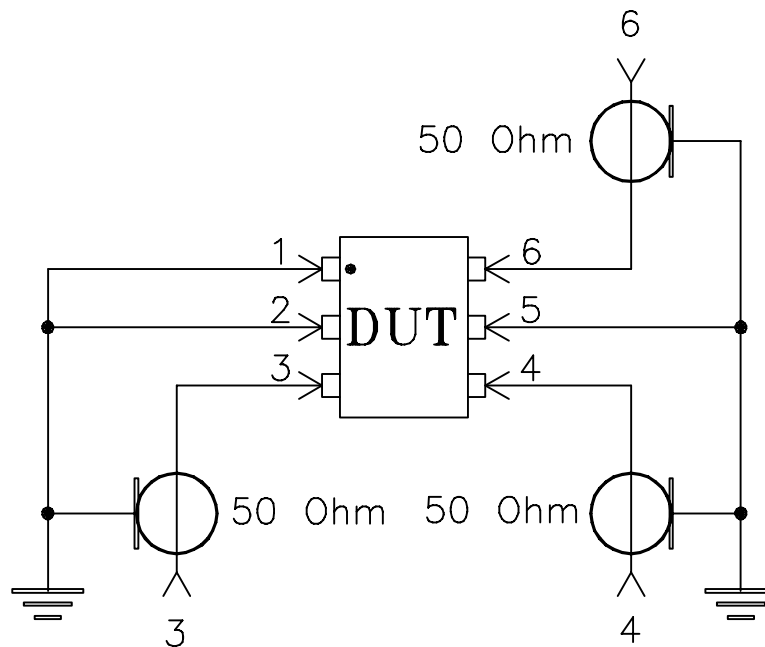

Schematic Diagram

## Notes:

1. SMA Female connectors.
2. PCB Material: Rogers R04350 or equivalent,  
Dielectric Constant=3.5, Thickness=.030 inch.

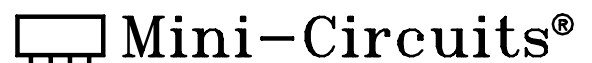



All Mini-Circuits products are manufactured under exacting quality assurance and control standards, and are capable of meeting published specifications after being subjected to any or all of the following physical and environmental test.

| Specification                  | Test/Inspection Condition   | Reference/Spec   |
|--------------------------------|---|--|
| Operating Temperature          | -40° to 85°C<br>Ambient Environment   | Individual Model Data Sheet  |
| Storage Temperature            | -55° to 100° C<br>Ambient Environment   | Individual Model Data Sheet  |
| Humidity                       | 90 to 95% RH, 240 hours, 50°C   | MIL-STD-202, Method 103, Condition A, Except 50°C and end-point electrical test done within 12 hours |
| Thermal Shock                  | -55° to 100°C, 100 cycles   | MIL-STD-202, Method 107, Condition A-3, except +100°C  |
| Solder Reflow Heat             | Sn-Pb Eutetic Process: 225°C peak<br>Pb-Free Process 245° - 250°C peak  | J-STD-020, Table 4-1, 4-2 and 5-2, Figure 5-1  |
| Solderability                  | 10X Magnification   | J-STD-002, 95% Coverage  |
| Vibration (High Frequency)     | 20g peak, 10-2000 Hz, 12 times in each of three perpendicular directions (total 36)   | MIL-STD-202, Method 204, Condition D   |
| Mechanical Shock               | 50g, 11 ms, 1/2-sine, 18 shocks: 3 each direction, each of 3 axes   | MIL-STD-202, Method 213, Condition A   |
| Marking Resistance to Solvents | Isopropyl alcohol + mineral spirits at 25°C; terpene defluxer at 25°C;<br>distilled water + proylene glycol monomethyl ether + monoethanolamine at 63°C to 70°C | MIL-STD-202, Method 215  |