

Frequency Mixer

ADE-ED12873/4

Level 10 (LO Power + 10 dBm)

Important Note

This model has been designed, built and tested in our engineering department. Performance data represents model capability. At present it is a non-catalog model. On request, we can supply a final specification sheet, part number and price/delivery information.



Please click "Back", and then click "Contact Us" for Applications support.

CASE STYLE : CD542

ELECTRICAL SPECIFICATIONS 50Ω @ +25°C					
Parameter		Min.	Typ.	Max.	Units
Frequency	LO (fL to fu)	800		1000	MHz
	RF (fL to fu)	800		1000	MHz
	IF	10		200	MHz
Conversion Loss	Total Range		6.4		dB
LO-RF Isolation			40		dB
LO-IF Isolation			30		dB
Input IP3			+19.72		dBm
1 dB Compression			+5		dBm

MAXIMUM RATINGS	
Operating Temperature	-40°C to +85°C
Storage Temperature	-55°C to +100°C

PIN CONNECTIONS	
LO	6
RF	4
IF	3
GROUND	1,2,5

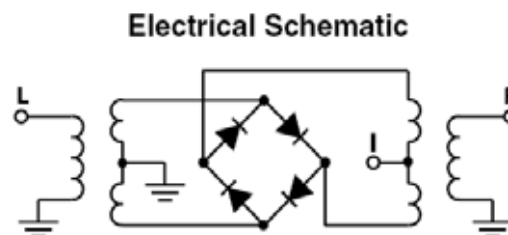

Frequency Mixer

ADE-ED12873/4

Typical Performance Data

RF (IN) (MHz)	LO (MHz)	CONVERSION LOSS IF FIXED @IF(OUT)=30MHz (dB)			RF (IN) (MHz)	LO (MHz)	IP3 INPUT (dBm)			RF (IN) (MHz)	LO (MHz)	COMPRESSION @RF IN=+5dBm (dB)		
		@LO (dBm)					@LO (dBm)					@LO (dBm)		
		+7	+10	+13			+7	+10	+13			+7	+10	+13
50.00	80.00	14.39	12.31	11.52	50.00	80.00	12.27	17.44	20.28	50.00	80.00	0.73	0.06	0.05
90.21	120.21	10.11	9.26	8.87	90.21	120.21	15.26	16.74	16.84	90.21	120.21	0.04	-0.01	0.01
130.41	160.41	8.34	7.65	7.43	130.41	160.41	15.13	15.82	16.43	130.41	160.41	-0.31	-0.16	-0.07
190.72	220.72	7.34	7.00	6.91	190.72	220.72	14.88	15.66	19.54	190.72	220.72	-0.51	-0.30	-0.12
230.93	260.93	7.03	6.72	6.54	230.93	260.93	14.13	16.75	22.09	230.93	260.93	-0.65	-0.38	-0.19
291.24	321.24	6.64	6.45	6.33	291.24	321.24	16.35	21.29	21.22	291.24	321.24	-0.74	-0.41	-0.25
331.44	361.44	6.60	6.37	6.26	331.44	361.44	16.48	22.04	19.33	331.44	361.44	-0.73	-0.42	-0.26
391.75	421.75	6.42	6.24	6.13	391.75	421.75	19.07	17.49	18.66	391.75	421.75	-0.73	-0.45	-0.29
431.96	461.96	6.40	6.19	6.05	431.96	461.96	17.86	16.93	17.36	431.96	461.96	-0.72	-0.44	-0.30
492.27	522.27	6.32	6.11	5.98	492.27	522.27	14.63	16.21	19.30	492.27	522.27	-0.77	-0.51	-0.37
532.47	562.47	6.42	6.20	6.05	532.47	562.47	13.85	13.89	16.10	532.47	562.47	-0.74	-0.50	-0.36
592.78	622.78	6.36	6.11	5.96	592.78	622.78	15.79	16.44	19.08	592.78	622.78	-0.87	-0.60	-0.45
632.99	662.99	6.45	6.19	6.05	632.99	662.99	14.91	17.81	22.56	632.99	662.99	-0.91	-0.64	-0.45
693.30	723.30	6.59	6.27	6.07	693.30	723.30	11.23	13.91	18.30	693.30	723.30	-0.95	-0.72	-0.55
733.51	763.51	6.76	6.44	6.21	733.51	763.51	10.90	12.10	15.42	733.51	763.51	-0.93	-0.73	-0.58
793.81	823.81	6.77	6.47	6.22	793.81	823.81	13.57	14.50	16.29	793.81	823.81	-1.07	-0.83	-0.69
834.02	864.02	6.78	6.44	6.20	834.02	864.02	14.92	16.39	19.06	834.02	864.02	-1.19	-0.92	-0.76
894.33	924.33	6.78	6.42	6.18	894.33	924.33	18.28	20.60	22.28	894.33	924.33	-1.36	-1.09	-0.90
934.54	964.54	6.74	6.37	6.14	934.54	964.54	19.91	20.02	18.67	934.54	964.54	-1.53	-1.25	-1.06
994.85	1024.85	6.83	6.40	6.13	994.85	1024.85	15.76	21.87	18.25	994.85	1024.85	-1.63	-1.36	-1.15
1035.05	1065.05	6.90	6.44	6.16	1035.05	1065.05	12.85	20.18	18.85	1035.05	1065.05	-1.75	-1.46	-1.22
1095.36	1125.36	7.09	6.50	6.20	1095.36	1125.36	9.79	16.44	21.54	1095.36	1125.36	-1.76	-1.54	-1.27
1135.57	1165.57	7.31	6.64	6.26	1135.57	1165.57	8.33	13.49	21.51	1135.57	1165.57	-1.70	-1.56	-1.30
1195.88	1225.88	7.75	7.00	6.51	1195.88	1225.88	6.77	10.30	15.50	1195.88	1225.88	-1.49	-1.41	-1.22
1236.08	1266.08	7.97	7.26	6.69	1236.08	1266.08	6.41	8.95	12.92	1236.08	1266.08	-1.46	-1.36	-1.23
1296.39	1326.39	8.12	7.48	6.88	1296.39	1326.39	7.40	8.97	13.15	1296.39	1326.39	-1.54	-1.39	-1.27
1336.60	1366.60	8.29	7.65	7.02	1336.60	1366.60	7.98	9.33	12.84	1336.60	1366.60	-1.48	-1.34	-1.25
1396.91	1426.91	8.33	7.65	7.03	1396.91	1426.91	8.80	10.80	13.96	1396.91	1426.91	-1.54	-1.40	-1.31
1437.11	1467.11	8.25	7.51	6.92	1437.11	1467.11	8.24	10.35	12.48	1437.11	1467.11	-1.65	-1.54	-1.44
1497.42	1527.42	8.11	7.41	6.95	1497.42	1527.42	8.27	10.35	11.57	1497.42	1527.42	-1.79	-1.66	-1.48
1537.63	1567.63	8.01	7.37	6.95	1537.63	1567.63	8.56	10.52	11.50	1537.63	1567.63	-1.97	-1.78	-1.56
1597.94	1627.94	8.15	7.53	7.16	1597.94	1627.94	8.90	10.54	11.85	1597.94	1627.94	-1.92	-1.73	-1.52
1638.14	1668.14	8.22	7.63	7.29	1638.14	1668.14	8.79	10.67	12.05	1638.14	1668.14	-1.92	-1.74	-1.56
1698.45	1728.45	8.64	8.11	7.77	1698.45	1728.45	9.75	11.39	12.84	1698.45	1728.45	-1.60	-1.48	-1.35
1738.66	1768.66	8.96	8.51	8.18	1738.66	1768.66	10.19	12.00	13.40	1738.66	1768.66	-1.41	-1.26	-1.16
1798.97	1828.97	9.41	9.04	8.75	1798.97	1828.97	11.26	12.70	13.93	1798.97	1828.97	-1.06	-0.88	-0.78
1839.18	1869.18	9.73	9.40	9.16	1839.18	1869.18	11.99	13.55	14.47	1839.18	1869.18	-0.83	-0.63	-0.51
1899.48	1929.48	9.87	9.61	9.39	1899.48	1929.48	13.96	14.36	15.25	1899.48	1929.48	-0.62	-0.40	-0.29
1939.69	1969.69	10.23	9.97	9.78	1939.69	1969.69	15.00	15.84	16.21	1939.69	1969.69	-0.45	-0.25	-0.18
2000.00	2030.00	10.35	10.10	9.93	2000.00	2030.00	15.18	17.57	17.97	2000.00	2030.00	-0.33	-0.17	-0.12

REV. X3

ADE-ED12873/4

101013

Page 1 of 5



IF/RF MICROWAVE COMPONENTS • ISO 9001 ISO 14001 AS 9100 CERTIFIED • RoHS compliant

P.O. Box 350166, Brooklyn, New York 11235-0006 (718) 934-4500 Fax (718) 332-4661



The Design Engineers Search Engine finds the model you need, instantly • For detailed performance specs & shopping online see



Typical Performance Data

IF (OUT) (MHz)	LO (MHz)	CONVERSION LOSS VS. IF FREQUENCY @RF(IN)=1010.1MHz (dB)	IF (OUT) (MHz)	LO (MHz)	CONVERSION LOSS VS. IF FREQUENCY @RF(IN)=189.9MHz (dB)	IF (OUT) (MHz)	LO (MHz)	CONVERSION LOSS VS. IF FREQUENCY @RF(IN)=1210.9MHz (dB)
		@LO (dBm)			@LO (dBm)			@LO (dBm)
		+10			+10			+10
210.10	800.00	6.60	10.10	200.00	7.08	1010.10	200.00	6.52
205.10	805.00	6.56	30.10	220.00	7.02	990.10	220.00	6.59
200.10	810.00	6.56	50.10	240.00	7.07	970.10	240.00	6.58
195.10	815.00	6.58	70.10	260.00	6.96	950.10	260.00	6.59
190.10	820.00	6.54	90.10	280.00	7.09	930.10	280.00	6.55
185.10	825.00	6.51	110.10	300.00	7.13	910.10	300.00	6.46
180.10	830.00	6.53	130.10	320.00	7.08	890.10	320.00	6.59
175.10	835.00	6.57	150.10	340.00	7.18	870.10	340.00	6.63
170.10	840.00	6.57	170.10	360.00	7.19	850.10	360.00	6.70
165.10	845.00	6.52	190.10	380.00	7.17	830.10	380.00	6.69
160.10	850.00	6.52	210.10	400.00	7.18	810.10	400.00	6.71
155.10	855.00	6.53	230.10	420.00	7.18	790.10	420.00	6.64
150.10	860.00	6.53	250.10	440.00	7.20	770.10	440.00	6.64
145.10	865.00	6.47	270.10	460.00	7.19	750.10	460.00	6.61
140.10	870.00	6.44	290.10	480.00	7.20	730.10	480.00	6.56
135.10	875.00	6.46	310.10	500.00	7.24	710.10	500.00	6.51
130.10	880.00	6.46	330.10	520.00	7.23	690.10	520.00	6.40
125.10	885.00	6.43	350.10	540.00	7.30	670.10	540.00	6.33
120.10	890.00	6.39	390.10	580.00	7.35	630.10	580.00	5.96
115.10	895.00	6.40	410.10	600.00	7.34	610.10	600.00	5.74
110.10	900.00	6.41	450.10	640.00	7.30	570.10	640.00	6.15
105.10	905.00	6.37	470.10	660.00	7.32	550.10	660.00	6.35
100.10	910.00	6.30	510.10	700.00	7.36	510.10	700.00	6.51
95.10	915.00	6.31	530.10	720.00	7.56	490.10	720.00	6.58
90.10	920.00	6.34	570.10	760.00	7.59	450.10	760.00	6.69
85.10	925.00	6.33	590.10	780.00	7.66	430.10	780.00	6.77
80.10	930.00	6.30	630.10	820.00	7.86	390.10	820.00	6.60
75.10	935.00	6.28	650.10	840.00	7.90	370.10	840.00	6.64
70.10	940.00	6.33	690.10	880.00	7.92	330.10	880.00	6.50
65.10	945.00	6.37	710.10	900.00	7.90	310.10	900.00	6.44
60.10	950.00	6.32	750.10	940.00	7.94	270.10	940.00	6.31
55.10	955.00	6.30	770.10	960.00	7.97	250.10	960.00	6.30
50.10	960.00	6.30	810.10	1000.00	7.95	210.10	1000.00	6.24
45.10	965.00	6.32	830.10	1020.00	7.94	190.10	1020.00	6.20
40.10	970.00	6.31	870.10	1060.00	7.82	150.10	1060.00	6.25
35.10	975.00	6.30	890.10	1080.00	7.80	130.10	1080.00	6.34
30.10	980.00	6.33	930.10	1120.00	7.71	90.10	1120.00	6.38
25.10	985.00	6.40	950.10	1140.00	7.66	70.10	1140.00	6.48
15.10	995.00	6.43	990.10	1180.00	7.61	30.10	1180.00	6.73
10.10	1000.00	6.48	1010.10	1200.00	7.63	10.10	1200.00	6.93

Frequency Mixer

ADE-ED12873/4

Typical Performance Data

LO (MHz)	LO-RF ISOLATION (dB)			LO-IF ISOLATION (dB)			RF (IN) (MHz)	LO (MHz)	RF-IF ISOLATION (dB)		
	@LO (dBm)			@LO (dBm)					@LO (dBm)		
	+7	+10	+13	+7	+10	+13			+7	+10	+13
80.00	67.79	67.13	64.85	58.14	48.41	44.84	50.00	80.00	43.89	43.15	42.92
120.21	60.84	59.58	58.24	48.74	45.91	44.11	120.21	120.21	41.23	40.97	41.01
160.41	55.51	54.59	54.10	46.74	44.49	43.11	130.41	160.41	39.40	40.04	40.52
220.72	50.69	50.62	50.73	45.51	43.59	42.29	190.72	220.72	39.52	40.82	42.03
260.93	48.84	49.05	49.03	45.34	43.54	41.83	230.93	260.93	38.08	39.74	40.79
321.24	46.82	47.15	47.39	45.97	43.59	41.44	291.24	321.24	38.28	40.13	41.39
361.44	45.95	46.19	46.18	46.62	43.53	40.68	331.44	361.44	37.91	39.38	39.58
421.75	44.60	45.07	45.19	46.35	42.79	39.89	391.75	421.75	38.16	38.81	39.35
461.96	43.74	44.03	44.09	44.81	42.11	39.56	431.96	461.96	38.23	38.97	39.05
522.27	43.20	43.64	43.78	42.29	40.26	37.89	492.27	522.27	35.27	35.64	35.36
562.47	42.78	43.05	43.19	40.24	39.91	38.15	532.47	562.47	34.08	34.29	33.70
622.78	42.13	42.54	42.65	37.36	37.39	36.63	592.78	622.78	32.41	32.25	31.52
662.99	41.74	42.06	42.06	36.13	36.09	35.32	632.99	662.99	31.32	31.45	31.11
723.30	41.44	41.77	41.77	34.58	35.79	35.64	693.30	723.30	30.91	30.92	30.59
763.51	41.23	41.51	41.48	33.18	34.44	35.10	733.51	763.51	30.72	30.33	29.69
823.81	41.15	41.27	41.29	32.08	32.97	33.72	793.81	823.81	31.21	30.41	29.31
864.02	41.27	41.24	41.07	31.14	31.75	32.31	834.02	864.02	30.82	29.82	28.45
924.33	41.09	40.57	40.25	30.84	30.76	30.74	894.33	924.33	28.89	27.78	26.95
964.54	41.34	40.68	40.14	30.83	31.06	30.81	934.54	964.54	27.82	26.78	26.02
1024.85	42.33	41.22	40.27	29.98	31.23	31.32	994.85	1024.85	26.36	25.53	24.72
1065.05	42.17	41.30	40.43	28.68	30.42	31.11	1035.05	1065.05	25.80	24.81	24.06
1125.36	41.48	40.88	40.12	27.39	29.34	30.49	1095.36	1125.36	25.51	24.47	23.62
1165.57	41.53	41.02	40.11	26.58	28.57	29.90	1135.57	1165.57	25.56	24.28	23.23
1225.88	41.35	41.05	40.33	25.78	27.79	29.59	1195.88	1225.88	25.68	24.16	22.89
1266.08	41.48	41.13	40.53	25.21	27.13	29.16	1236.08	1266.08	26.06	24.39	22.96
1326.39	41.56	41.31	40.85	24.57	26.25	28.29	1296.39	1326.39	27.50	25.70	23.70
1366.60	41.84	41.69	41.22	24.00	25.54	27.29	1336.60	1366.60	27.76	26.06	23.95
1426.91	41.72	41.49	40.76	23.97	25.26	26.51	1396.91	1426.91	28.29	25.96	23.70
1467.11	41.83	41.46	40.48	24.32	25.59	26.59	1437.11	1467.11	26.56	24.34	22.37
1527.42	42.53	41.81	40.62	25.14	26.53	27.43	1497.42	1527.42	22.59	20.94	19.75
1567.63	42.59	41.91	40.81	25.33	26.88	27.94	1537.63	1567.63	20.69	19.37	18.37
1627.94	42.96	43.24	42.52	25.40	27.38	29.13	1597.94	1627.94	18.17	17.18	16.48
1668.14	42.12	43.62	43.29	24.79	27.09	29.24	1638.14	1668.14	16.90	16.07	15.47
1728.45	40.49	43.68	44.93	24.05	26.69	29.32	1698.45	1728.45	15.17	14.58	14.13
1768.66	39.61	43.45	46.09	23.56	26.27	28.99	1738.66	1768.66	14.22	13.61	13.25
1828.97	38.67	42.84	46.76	23.62	26.36	29.16	1798.97	1828.97	12.96	12.39	12.06
1869.18	38.05	42.18	46.53	23.53	26.21	29.01	1839.18	1869.18	12.37	11.80	11.42
1929.48	37.53	41.47	45.67	23.92	26.61	29.34	1899.48	1929.48	11.55	10.94	10.60
1969.69	36.96	40.60	44.29	23.91	26.55	29.21	1939.69	1969.69	11.03	10.46	10.00
2030.00	36.56	39.98	43.09	24.55	27.10	29.63	2000.00	2030.00	10.42	9.74	9.37



Frequency Mixer

ADE-ED12873/4

Typical Performance Data

RF (IN) (MHz)	LO (MHz)	RF VSWR (:1)			LO (MHz)	LO VSWR (:1)			IF (OUT) (MHz)	IF VSWR @LO=1000MHz (:1)		
		@LO (dBm)				@LO (dBm)				@LO (dBm)		
		+7	+10	+13		+7	+10	+13		+7	+10	+13
50.00	80.00	13.70	13.09	11.46	80.00	15.96	10.89	7.83	10.00	1.78	1.49	1.32
90.21	120.21	5.23	4.64	4.64	120.21	5.41	4.43	4.46	14.75	1.75	1.47	1.30
130.41	160.41	3.58	3.37	3.21	160.41	3.37	3.36	3.90	19.50	1.74	1.46	1.29
190.72	220.72	2.43	2.38	2.34	220.72	2.53	2.84	3.54	24.25	1.75	1.47	1.30
230.93	260.93	2.15	2.12	2.11	260.93	2.30	2.75	3.54	29.00	1.78	1.50	1.33
291.24	321.24	1.87	1.86	1.87	321.24	2.04	2.58	3.40	33.75	1.82	1.54	1.36
331.44	361.44	1.77	1.76	1.76	361.44	1.97	2.57	3.42	38.50	1.85	1.56	1.37
391.75	421.75	1.67	1.67	1.68	421.75	1.85	2.50	3.36	43.25	1.86	1.56	1.39
431.96	461.96	1.61	1.61	1.62	461.96	1.82	2.50	3.37	48.00	1.85	1.56	1.38
492.27	522.27	1.56	1.57	1.58	522.27	1.78	2.49	3.37	52.75	1.82	1.54	1.36
532.47	562.47	1.51	1.52	1.53	562.47	1.77	2.49	3.37	57.50	1.79	1.51	1.33
592.78	622.78	1.50	1.51	1.52	622.78	1.77	2.50	3.38	62.25	1.77	1.49	1.31
632.99	662.99	1.46	1.47	1.48	662.99	1.76	2.48	3.35	67.00	1.77	1.49	1.31
693.30	723.30	1.46	1.47	1.48	723.30	1.78	2.52	3.38	71.75	1.78	1.50	1.33
733.51	763.51	1.44	1.44	1.44	763.51	1.79	2.52	3.38	76.50	1.80	1.52	1.34
793.81	823.81	1.44	1.44	1.44	823.81	1.83	2.58	3.45	81.25	1.81	1.54	1.35
834.02	864.02	1.42	1.42	1.42	864.02	1.85	2.58	3.43	86.00	1.82	1.54	1.36
894.33	924.33	1.39	1.40	1.40	924.33	1.89	2.63	3.50	90.75	1.81	1.54	1.36
934.54	964.54	1.36	1.35	1.36	964.54	1.92	2.66	3.52	95.50	1.79	1.51	1.34
994.85	1024.85	1.33	1.33	1.35	1024.85	2.01	2.77	3.66	100.25	1.77	1.50	1.32
1035.05	1065.05	1.30	1.29	1.31	1065.05	2.07	2.83	3.73	105.00	1.76	1.49	1.31
1095.36	1125.36	1.25	1.26	1.30	1125.36	2.19	2.98	3.90	109.75	1.77	1.50	1.33
1135.57	1165.57	1.22	1.22	1.26	1165.57	2.27	3.07	3.99	114.50	1.80	1.52	1.35
1195.88	1225.88	1.16	1.19	1.25	1225.88	2.39	3.21	4.16	119.25	1.85	1.55	1.37
1236.08	1266.08	1.13	1.14	1.20	1266.08	2.47	3.31	4.27	124.00	1.88	1.58	1.40
1296.39	1326.39	1.06	1.12	1.20	1326.39	2.57	3.43	4.43	128.75	1.89	1.59	1.41
1336.60	1366.60	1.02	1.09	1.17	1366.60	2.63	3.49	4.47	133.50	1.89	1.59	1.41
1396.91	1426.91	1.18	1.24	1.31	1426.91	2.70	3.56	4.56	138.25	1.87	1.57	1.39
1437.11	1467.11	1.30	1.34	1.41	1467.11	2.73	3.58	4.57	143.00	1.84	1.55	1.37
1497.42	1527.42	1.59	1.64	1.69	1527.42	2.77	3.63	4.64	147.75	1.82	1.53	1.36
1537.63	1567.63	1.77	1.80	1.84	1567.63	2.80	3.67	4.68	152.50	1.81	1.53	1.35
1597.94	1627.94	2.18	2.19	2.21	1627.94	2.91	3.78	4.80	157.25	1.82	1.54	1.36
1638.14	1668.14	2.40	2.40	2.39	1668.14	2.99	3.83	4.84	162.00	1.85	1.56	1.38
1698.45	1728.45	2.92	2.88	2.86	1728.45	3.11	3.95	4.96	166.75	1.87	1.58	1.40
1738.66	1768.66	3.18	3.13	3.09	1768.66	3.20	4.01	4.99	171.50	1.88	1.59	1.41
1798.97	1828.97	3.70	3.65	3.61	1828.97	3.41	4.18	5.14	176.25	1.88	1.59	1.41
1839.18	1869.18	3.86	3.84	3.81	1869.18	3.56	4.26	5.17	181.00	1.85	1.57	1.39
1899.48	1929.48	4.25	4.24	4.21	1929.48	3.85	4.48	5.38	185.75	1.83	1.55	1.37
1939.69	1969.69	4.38	4.36	4.33	1969.69	4.02	4.56	5.38	195.25	1.83	1.54	1.37
2000.00	2030.00	4.64	4.60	4.55	2030.00	4.36	4.82	5.61	200.00	1.86	1.57	1.40

REV. X3

ADE-ED12873/4

101013

Page 4 of 5



IF/RF MICROWAVE COMPONENTS • ISO 9001 ISO 14001 AS 9100 CERTIFIED • RoHS compliant

P.O. Box 350166, Brooklyn, New York 11235-0006 (718) 934-4500 Fax (718) 332-4661



The Design Engineers Search Engine finds the model you need, instantly • For detailed performance specs & shopping online see



Harmonics Tables

RF HARMONICS ORDER	(-dBm)	(-dBc)										
		0	1	2	3	4	5	6	7	8	9	10
0	-	-	7	20	10	32	27	29	16	29	39	56
1	-	23	+0	25	11	36	20	38	43	32	43	43
2	79	59	43	58	44	58	42	60	66	60	52	54
3	> 90	62	62	62	62	71	57	65	64	> 74	68	68
4	> 90	> 74	> 74	> 74	> 74	> 74	> 74	> 74	> 74	> 74	> 74	> 74
5	> 90	> 74	> 74	> 74	> 74	> 74	> 74	> 74	> 74	> 74	> 74	> 74
6	> 90	> 74	> 74	> 74	> 74	> 74	> 74	> 74	> 74	> 74	> 74	> 74
7	> 90	> 74	> 74	> 74	> 74	> 74	> 74	> 74	> 74	> 74	> 74	> 74
8	> 90	> 74	> 74	> 74	> 74	> 74	> 74	> 74	> 74	> 74	> 74	> 74
9	> 90	> 74	> 74	> 74	> 74	> 74	> 74	> 74	> 74	> 74	> 74	> 74
10	> 90	> 74	> 74	> 74	> 74	> 74	> 74	> 74	> 74	> 74	> 74	> 74
	RF CAL	0	1	2	3	4	5	6	7	8	9	10

LO HARMONICS ORDER

Test conditions: RF IN: 650.00 MHz; -10.00 dBm.
 LO IN: 680.00 MHz; +10.00 dBm
 IF OUT: 30.00 MHz; -16.42 dBm

RF HARMONICS ORDER	(-dBm)	(-dBc)										
		0	1	2	3	4	5	6	7	8	9	10
0	-	-	15	30	23	44	35	40	28	42	58	67
1	-	24	+0	25	11	43	21	42	41	39	49	51
2	60	50	36	53	34	50	35	54	63	69	43	54
3	> 90	44	40	42	54	46	39	45	52	60	62	48
4	> 90	69	61	58	54	56	51	53	49	66	72	60
5	> 90	67	66	58	53	71	53	63	52	63	57	74
6	> 90	> 84	79	> 84	68	72	67	74	60	63	62	74
7	> 90	78	> 84	82	72	72	77	73	> 84	69	74	70
8	> 90	> 84	83	> 84	> 84	> 84	82	79	76	76	71	70
9	> 90	> 84	> 84	84	> 84	> 84	80	76	76	> 84	79	> 84
10	> 90	> 84	> 84	> 84	> 84	> 84	> 84	> 84	> 84	> 84	> 84	> 84
	RF CAL	0	1	2	3	4	5	6	7	8	9	10

LO HARMONICS ORDER

Test conditions: RF IN: 650.00 MHz; .00 dBm
 LO IN: 680.00 MHz; +10.00 dBm
 IF OUT: 30.00 MHz; -6.45 dBm

- Notes: 1. All Harmonics are in (dBc) relative to IF OUTPUT.
 2. + entry denotes harmonics are in (dBc) above IF OUTPUT.
 3. RF Cal represent the Harmonics level of the RF input signal to the mixer.

Typical Performance Curves

Conversion Loss @ IF=30 MHz

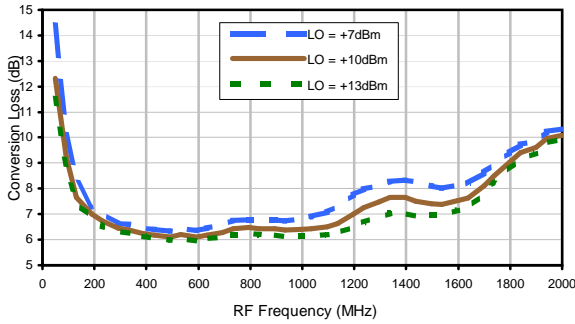

Conversion Loss vs. IF @ RF=1010.1 MHz

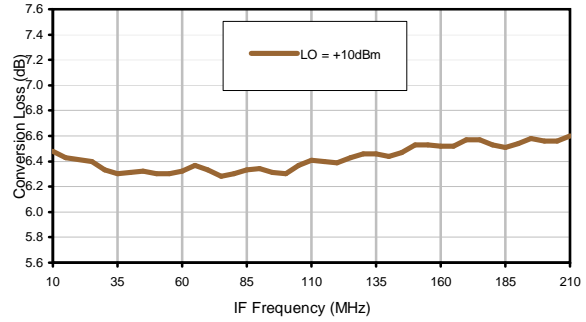

Conversion Loss vs. IF @ RF=189.9 MHz

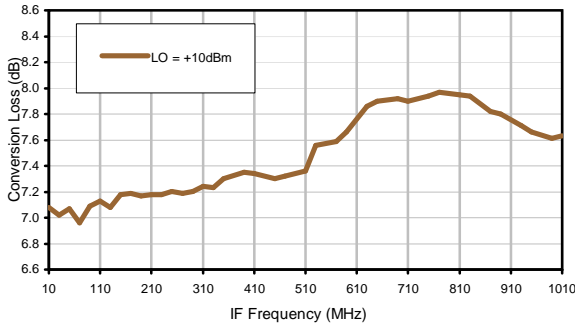

Conversion Loss vs. IF @ RF=1210.9 MHz

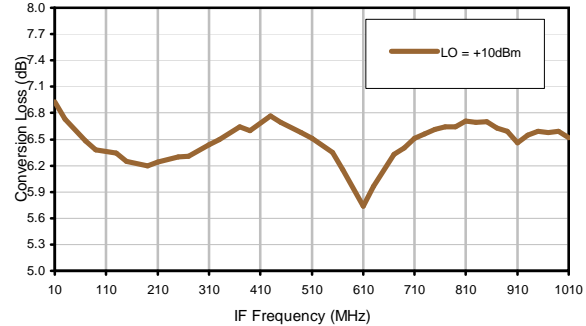

IP3 Input

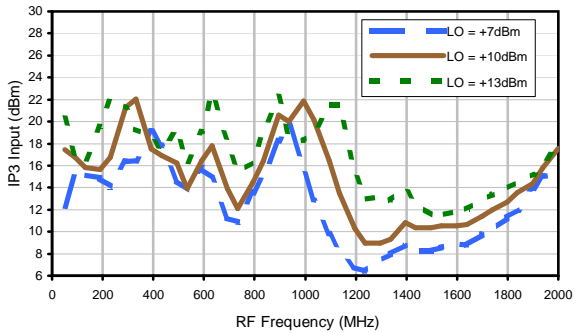

Compression @ RF IN = +5 dBm

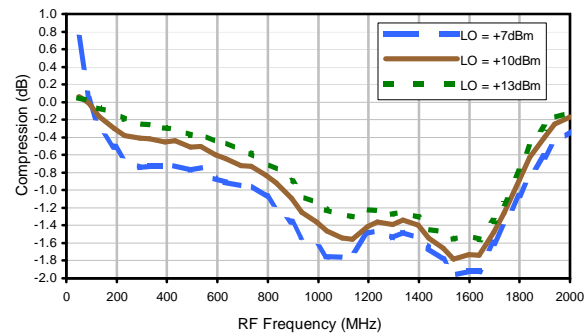

Typical Performance Curves

LO-RF Isolation

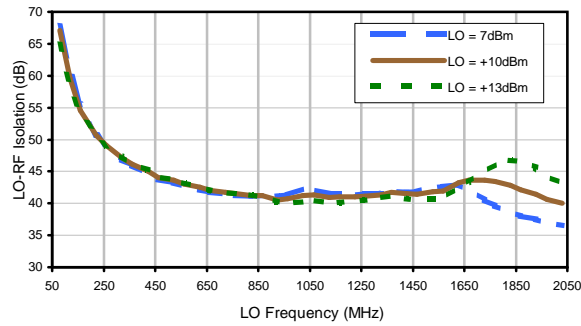

LO-IF Isolation

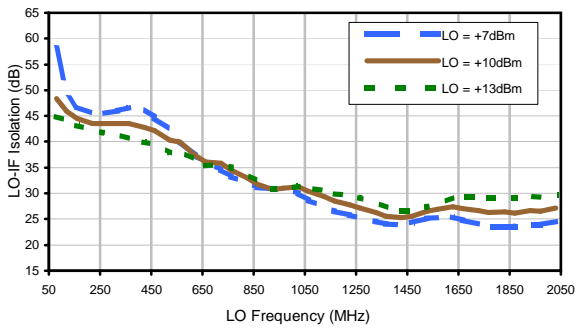

RF-IF Isolation

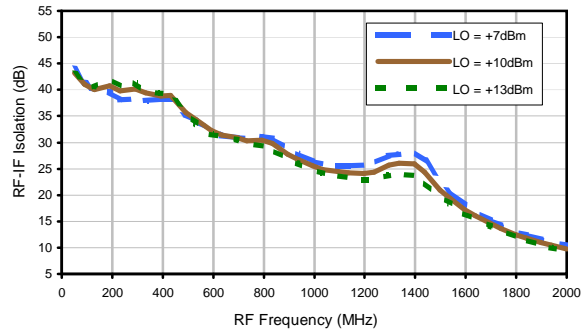

RF VSWR

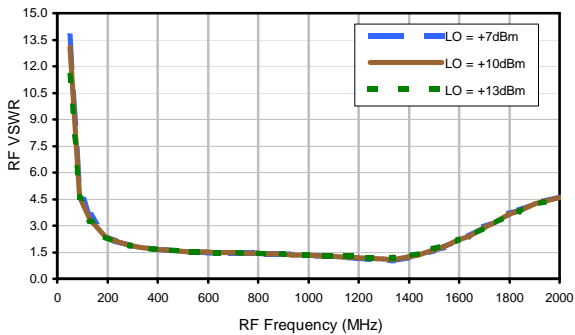

LO VSWR

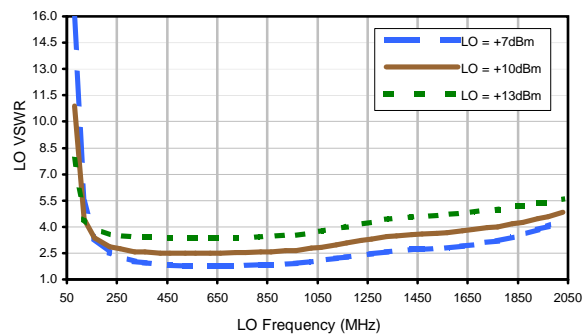

IF VSWR

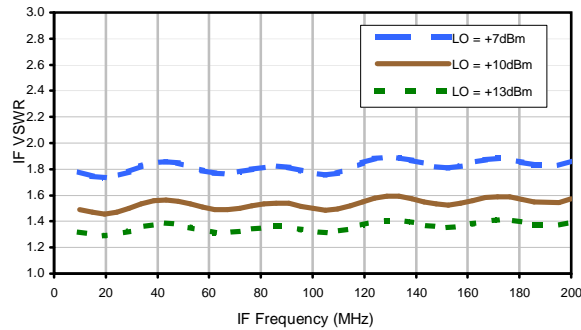

Harmonics Tables

RF HARMONICS ORDER

	(-dBm)	(-dBc)										
0	-	-	7	20	10	32	27	29	16	29	39	56
1	-	23	+0	25	11	36	20	38	43	32	43	43
2	79	59	43	58	44	58	42	60	66	60	52	54
3	> 90	62	62	62	62	71	57	65	64	> 74	68	68
4	> 90	> 74	> 74	> 74	> 74	> 74	> 74	> 74	> 74	> 74	> 74	> 74
5	> 90	> 74	> 74	> 74	> 74	> 74	> 74	> 74	> 74	> 74	> 74	> 74
6	> 90	> 74	> 74	> 74	> 74	> 74	> 74	> 74	> 74	> 74	> 74	> 74
7	> 90	> 74	> 74	> 74	> 74	> 74	> 74	> 74	> 74	> 74	> 74	> 74
8	> 90	> 74	> 74	> 74	> 74	> 74	> 74	> 74	> 74	> 74	> 74	> 74
9	> 90	> 74	> 74	> 74	> 74	> 74	> 74	> 74	> 74	> 74	> 74	> 74
10	> 90	> 74	> 74	> 74	> 74	> 74	> 74	> 74	> 74	> 74	> 74	> 74
	RF CAL	0	1	2	3	4	5	6	7	8	9	10

LO HARMONICS ORDER

Test conditions: RF IN: 650.00 MHz; -10.00 dBm.
 LO IN: 680.00 MHz; +10.00 dBm
 IF OUT: 30.00 MHz; -16.42 dBm

RF HARMONICS ORDER

	(-dBm)	(-dBc)										
0	-	-	15	30	23	44	35	40	28	42	58	67
1	-	24	+0	25	11	43	21	42	41	39	49	51
2	60	50	36	53	34	50	35	54	63	69	43	54
3	> 90	44	40	42	54	46	39	45	52	60	62	48
4	> 90	69	61	58	54	56	51	53	49	66	72	60
5	> 90	67	66	58	53	71	53	63	52	63	57	74
6	> 90	> 84	79	> 84	68	72	67	74	60	63	62	74
7	> 90	78	> 84	82	72	72	77	73	> 84	69	74	70
8	> 90	> 84	83	> 84	> 84	> 84	82	79	76	76	71	70
9	> 90	> 84	> 84	84	> 84	> 84	80	76	76	> 84	79	> 84
10	> 90	> 84	> 84	> 84	> 84	> 84	> 84	> 84	> 84	> 84	> 84	> 84
	RF CAL	0	1	2	3	4	5	6	7	8	9	10

LO HARMONICS ORDER

Test conditions: RF IN: 650.00 MHz; .00 dBm
 LO IN: 680.00 MHz; +10.00 dBm
 IF OUT: 30.00 MHz; -6.45 dBm

- Notes: 1. All Harmonics are in (dBc) relative to IF OUTPUT.
 2. + entry denotes harmonics are in (dBc) above IF OUTPUT.
 3. RF Cal represent the Harmonics level of the RF input signal to the mixer.

Case Style

CD

CD541
CD542
CD636
CD637

Outline Dimensions



PCB Land Pattern



Suggested Layout,
Tolerance to be within $\pm .002$

CASE#	A	B	C	D	E	F	G	H	J	K	L	WT, GRAM
CD541					.082 (2.08)							.15
CD542	.272 (6.91)	.310 (7.87)	.220 (5.58)	.100 (2.54)	.112 (2.84)	.055 (1.40)	.100 (2.54)	.030 (0.76)	.026 (0.66)	.065 (1.65)	.300 (7.62)	.20
CD636					.162 (4.11)							.25
CD637					.206 (5.23)							.40

Dimensions are in inches (mm). Tolerances: 2 Pl. $\pm .01$; 3 Pl. $\pm .005$

Notes:

- Case material: Plastic.
- Termination finish:
 - For RoHS Case Styles: Tin plate over Nickel plate. All models, (+) suffix.
 - For RoHS-5 Case Styles: Tin-Lead plate. All models, no (+) suffix.

Mini-Circuits

INTERNET <http://www.minicircuits.com>

P.O. Box 350166, Brooklyn, New York 11235-0003 (718) 934-4500 Fax (718) 332-4661

Distribution Centers NORTH AMERICA 800-654-7949 • 417-335-5935 • Fax 417-335-5945 • EUROPE 44-1252-832600 • Fax 44-1252-837010

Mini-Circuits ISO 9001 & ISO 14001 Certified

Tape & Reel Packaging TR-F34



Tape Width, mm	Device Cavity Pitch, mm	Reel Size, inches	Devices per Reel see note	
16	12	7	Small quantity standard (see note)	20
				50
			100	
			200	
		13	Standard	500
				1000

Note: Availability of small reel quantity varies by model.
Refer to pricing and availability on individual model dashboard.

Mini-Circuits carrier tape materials provide protection from ESD (Electro-Static Discharge) during handling and transportation. Tapes are static dissipative and comply with industry standards EIA-481/EIA-541.

Go to: www.minicircuits.com/pages/pdfs/tape.pdf



INTERNET <http://www.minicircuits.com>

P.O. Box 350166, Brooklyn, New York 11235-0003 (718) 934-4500 Fax (718) 332-4661

Distribution Centers NORTH AMERICA 800-654-7949 • 417-335-5935 • Fax 417-335-5945 • EUROPE 44-1252-832600 • Fax 44-1252-837010

Mini-Circuits ISO 9001 & ISO 14001 Certified

THIRD ANGLE PROJECTION

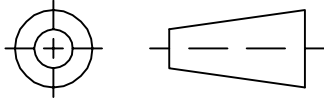

REVISIONS

REV	ECN No.	DESCRIPTION	DATE	DR	AUTH
OR	M82272	NEW RELEASE	08/05/02	MMG	DJ
A	M102713	ADDED NOTE 2 & "...WITH SMOBC"	01/17/06	MMG	IL

**SUGGESTED MOUNTING CONFIGURATION
FOR CD541/542/636/637 CASE STYLES,
"jv", "ju", "jw" PIN CONNECTIONS**

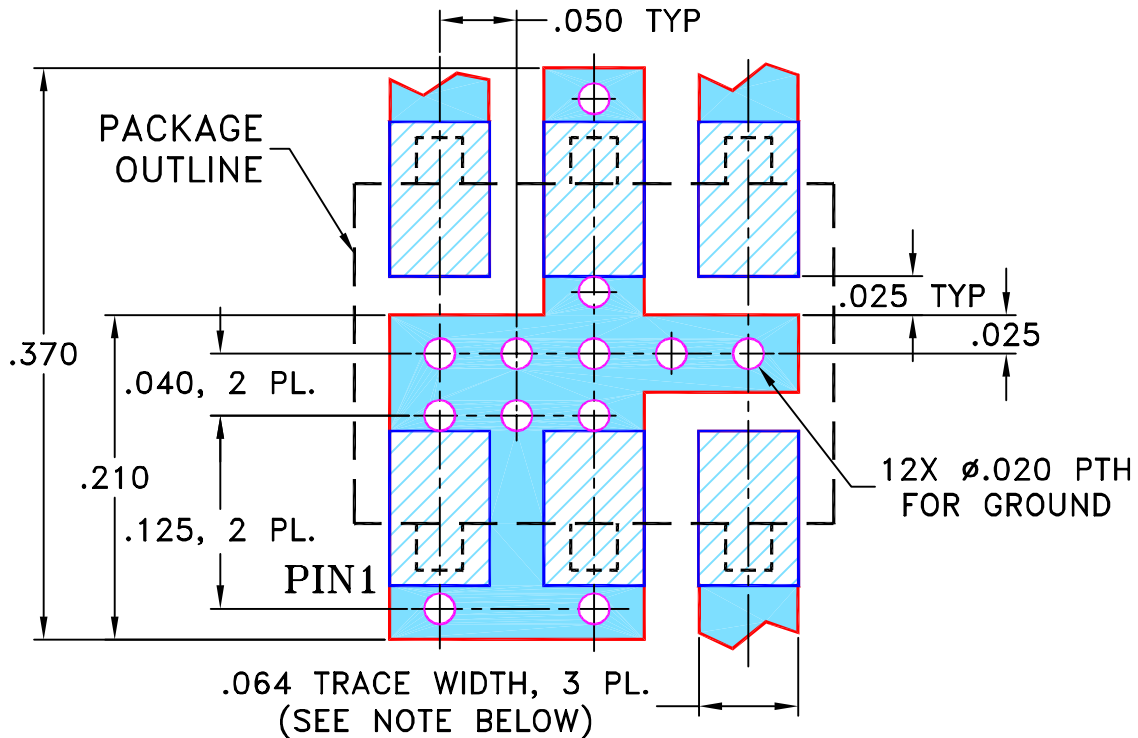

- NOTES:** 1. TRACE WIDTH IS SHOWN FOR ROGERS R04350B WITH DIELECTRIC THICKNESS .030" ± .002"; COPPER: 1/2 OZ. EACH SIDE. FOR OTHER MATERIALS TRACE WIDTH MAY NEED TO BE MODIFIED.
2. BOTTOM SIDE OF THE PCB IS CONTINUOUS GROUND PLANE.

- DENOTES PCB COPPER LAYOUT WITH SMOBC (SOLDER MASK OVER BARE COPPER)
- DENOTES COPPER LAND PATTERN FREE OF SOLDER MASK

UNLESS OTHERWISE SPECIFIED

DIMENSIONS ARE IN INCHES
TOLERANCES ON:
2 PL DECIMALS ±
3 PL DECIMALS ± .005
ANGLES ±
FRACTIONS ±

	INITIALS	DATE
DRAWN	MMG	07/17/02
CHECKED	WL	08/02/02
APPROVED	DJ	08/05/02



Mini-Circuits®

13 Neptune Avenue
Brooklyn NY 11235

PL, jv/ju/jw, CD541/542/636/637, ADE, TB-02

Mini-Circuits®
THIS DOCUMENT AND ITS CONTENTS ARE THE PROPERTY OF MINI-CIRCUITS. EXCEPT FOR USE EXPRESSLY GRANTED, IN WRITING, TO ITS VENDORS, VENDEE AND THE UNITED STATES GOVERNMENT, MINI-CIRCUITS RESERVES ALL PROPRIETARY DESIGN, USE, MANUFACTURING AND REPRODUCTION RIGHTS THERETO. THESE CONTENTS SHALL NOT BE USED, DUPLICATED OR DISCLOSED TO ANY OUTSIDE PARTY, IN WHOLE OR IN PART, WITHOUT WRITTEN PERMISSION OF MINI-CIRCUITS.

ASHEETA1.DWG REV:A DATE:01/12/95

SIZE	CODE IDENT	DRAWING NO:	REV:
A	15542	98-PL-051	A
FILE:	98PL051	SCALE: 8:1	SHEET: 1 OF 1

Evaluation Board and Circuit

For Pin Connections refer to Data Sheet of the DUT

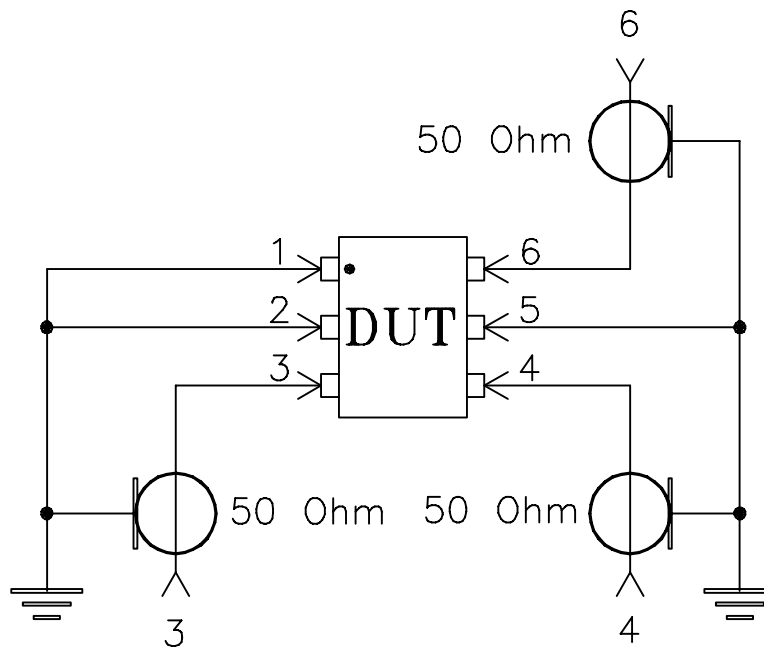
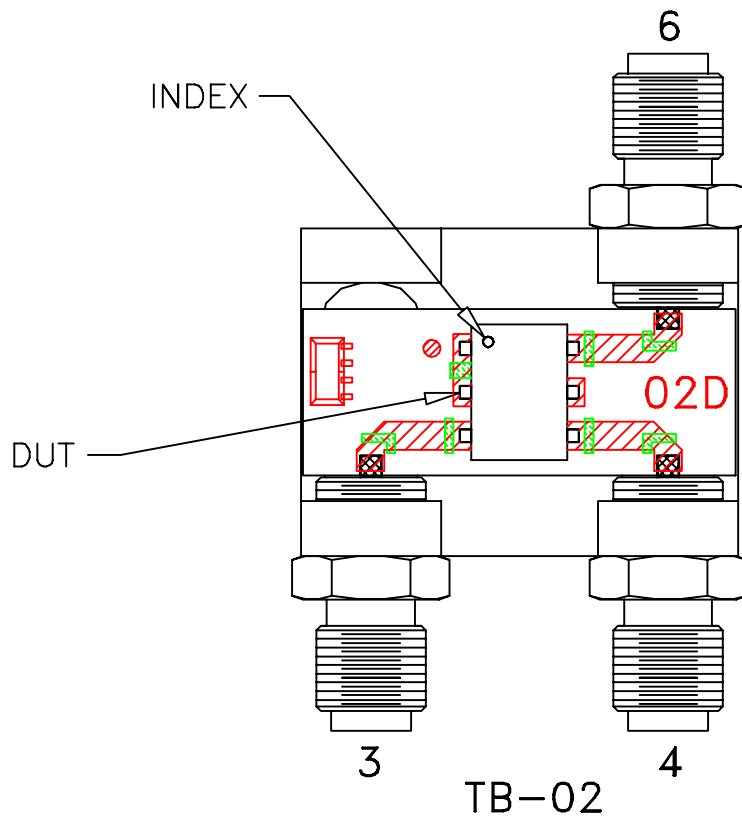

Schematic Diagram

Notes:

1. SMA Female connectors.
2. PCB Material: Rogers R04350 or equivalent,
Dielectric Constant=3.5, Thickness=.030 inch.

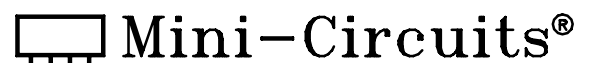



All Mini-Circuits products are manufactured under exacting quality assurance and control standards, and are capable of meeting published specifications after being subjected to any or all of the following physical and environmental test.

Specification	Test/Inspection Condition	Reference/Spec
Operating Temperature	-40° to 85°C Ambient Environment	Individual Model Data Sheet
Storage Temperature	-55° to 100° C Ambient Environment	Individual Model Data Sheet
Humidity	90 to 95% RH, 240 hours, 50°C	MIL-STD-202, Method 103, Condition A, Except 50°C and end-point electrical test done within 12 hours
Thermal Shock	-55° to 100°C, 100 cycles	MIL-STD-202, Method 107, Condition A-3, except +100°C
Solder Reflow Heat	Sn-Pb Eutetic Process: 225°C peak Pb-Free Process 245° - 250°C peak	J-STD-020, Table 4-1, 4-2 and 5-2, Figure 5-1
Solderability	10X Magnification	J-STD-002, 95% Coverage
Vibration (High Frequency)	20g peak, 10-2000 Hz, 12 times in each of three perpendicular directions (total 36)	MIL-STD-202, Method 204, Condition D
Mechanical Shock	50g, 11 ms, 1/2-sine, 18 shocks: 3 each direction, each of 3 axes	MIL-STD-202, Method 213, Condition A
Marking Resistance to Solvents	Isopropyl alcohol + mineral spirits at 25°C; terpene defluxer at 25°C; distilled water + proylene glycol monomethyl ether + monoethanolamine at 63°C to 70°C	MIL-STD-202, Method 215