

# Engineering Development Model

## Frequency Mixer

# ADE-ED7878/1

### Level 10 (LO Power +10 dBm)

#### Important Note

This model has been designed, built and tested in our engineering department. Performance data represents model capability. At present it is a non-catalog model. On request, we can supply a final specification sheet, part number and price/delivery information.



Please click "Back", and then click "Contact Us" for Applications support.

**CASE STYLE : CD542**

ELECTRICAL SPECIFICATIONS 50Ω @ +25°C					
Parameter		Min.	Typ.	Max.	Units
Frequency	LO (fL to fU)	0.5		1050	MHz
	RF (fL to fU)	0.5		1050	MHz
	IF	0.2		1000	MHz
Conversion Loss	mid band		6.0		dB
	Total Range		6.2		dB
LO-RF Isolation	Low Range		-		dB
	Mid Range		53		dB
	Upper Range		38		dB
LO-IF Isolation	Low Range		-		dB
	Mid Range		56		dB
	Upper Range		35		dB

**Note:** Low Range = [fL to 10fL]      Mid Range = [10fL to fU/2]      Upper Range = [fU/2 to fU]  
 mid band = [2fL to fU/2]

MAXIMUM RATINGS	
Operating Temperature	-40°C to 85°C
Storage Temperature	-55°C to 100°C

PIN CONNECTIONS	
LO	6
RF	3
IF	2
GROUND	1, 4, 5

# Frequency Mixer

# ADE-ED7878/1

## Typical Performance Data

RF (MHz)	LO (MHz)	CONVERSION LOSS (dB)			LO (MHz)	LO-RF ISOLATION (dB)			LO-IF ISOLATION (dB)		
		@LO (dBm)				@LO (dBm)			@LO (dBm)		
		+7	+10	+13		+7	+10	+13	+7	+10	+13
0.5	30.5	9.18	8.68	8.28	30.5	60.3	62.1	64.2	60.4	61.2	61.2
1.0	31.0	8.02	7.52	7.22	31.0	60.3	61.9	63.8	60.3	60.9	61.1
2.0	32.0	7.06	6.66	6.46	32.0	60.3	61.6	64.1	60.3	61.1	61.2
5.0	35.0	6.38	6.08	5.78	35.0	60.0	61.5	63.7	60.5	61.1	61.2
10.0	40.0	6.17	5.87	5.67	40.0	59.6	61.0	63.3	60.7	61.4	61.8
20.0	50.0	6.05	5.85	5.55	50.0	58.3	59.5	61.7	61.0	61.3	61.8
50.0	80.0	6.15	5.85	5.65	80.0	54.2	55.9	57.4	62.4	62.2	62.7
75.1	105.1	6.13	5.83	5.63	105.1	52.2	53.7	55.3	64.3	63.8	64.2
100.0	130.0	6.10	5.90	5.60	130.0	50.0	51.6	53.6	65.5	64.2	64.1
150.1	180.1	5.99	5.79	5.49	180.1	46.3	48.6	51.5	61.3	60.4	64.4
225.1	255.1	6.20	5.80	5.60	255.1	44.7	46.6	48.5	51.5	50.9	54.6
300.1	330.1	6.19	5.89	5.79	330.1	43.1	44.7	46.4	44.7	46.7	50.4
375.1	405.1	6.18	5.88	5.78	405.1	40.8	42.7	44.6	41.8	44.8	48.1
450.1	480.1	6.26	5.86	5.76	480.1	39.0	40.6	42.5	39.2	42.1	45.1
470.0	500.0	6.12	5.92	5.62	500.0	38.8	40.3	42.2	38.8	41.6	44.7
500.0	530.0	6.14	5.84	5.74	530.0	38.6	40.3	42.2	38.4	41.6	45.0
525.1	555.1	6.22	5.82	5.72	555.1	38.8	40.5	42.1	38.2	41.5	44.7
600.1	630.1	6.29	5.99	5.79	630.1	39.3	41.3	42.6	37.4	40.2	42.1
675.1	705.1	6.30	6.00	5.80	705.1	38.7	41.0	42.5	35.8	38.0	39.4
750.0	780.0	6.62	6.22	6.02	780.0	37.7	39.6	40.9	33.3	35.5	36.6
825.0	855.0	6.66	6.36	6.06	855.0	35.9	37.7	38.6	31.0	32.7	33.7
900.0	930.0	6.67	6.17	5.87	930.0	34.1	35.7	36.6	29.0	30.2	30.9
970.0	1000.0	6.63	6.13	5.83	1000.0	32.5	34.5	35.4	28.2	29.5	30.5
975.0	1005.0	6.58	6.08	5.78	1005.0	32.5	34.5	35.4	28.2	29.7	30.5
1000.0	1030.0	6.67	6.07	5.77	1030.0	32.2	33.9	35.3	28.0	29.4	30.3
1030.0	1060.0	6.68	6.18	5.88	1060.0	31.7	33.4	34.7	28.0	29.5	30.1
1050.0	1080.0	6.76	6.16	5.86	1080.0	31.6	33.2	34.7	28.1	29.2	30.0

# Frequency Mixer

# ADE-ED7878/1

## Typical Performance Data

RF/LO (MHz)	RF VSWR (:1)			LO VSWR (:1)			IF (MHz)	IF VSWR (:1)		
	@LO (dBm)			@LO (dBm)				@LO (dBm)		
	+7	+10	+13	+7	+10	+13		+7	+10	+13
30.5	2.96	2.92	2.88	1.12	1.63	2.43	0.1	1.57	1.32	1.22
31.0	2.04	2.04	2.04	1.10	1.66	2.43	0.2	1.55	1.30	1.20
32.0	1.59	1.59	1.61	1.11	1.65	2.43	0.5	1.61	1.36	1.25
35.0	1.27	1.26	1.28	1.11	1.65	2.40	1.0	1.67	1.40	1.28
40.0	1.15	1.13	1.17	1.14	1.63	2.43	5.0	1.63	1.38	1.27
50.0	1.08	1.06	1.13	1.17	1.63	2.46	10.0	1.64	1.37	1.27
80.0	1.03	1.01	1.14	1.20	1.64	2.37	30.0	1.63	1.37	1.27
105.1	1.05	1.02	1.14	1.17	1.63	2.40	50.0	1.62	1.37	1.27
130.0	1.04	1.03	1.15	1.20	1.63	2.37	100.0	1.65	1.41	1.30
180.1	1.01	1.06	1.17	1.23	1.64	2.46	150.1	1.66	1.44	1.34
255.1	1.04	1.08	1.14	1.21	1.67	2.40	200.1	1.67	1.46	1.37
330.1	1.03	1.11	1.15	1.23	1.69	2.43	250.0	1.66	1.46	1.39
405.1	1.05	1.12	1.17	1.25	1.71	2.46	300.1	1.65	1.47	1.41
480.1	1.10	1.15	1.19	1.23	1.70	2.43	350.1	1.62	1.45	1.40
500.0	1.11	1.17	1.21	1.23	1.74	2.46	400.1	1.59	1.43	1.39
530.0	1.13	1.20	1.25	1.23	1.75	2.49	450.1	1.56	1.41	1.39
555.1	1.14	1.20	1.25	1.23	1.74	2.37	500.0	1.56	1.40	1.39
630.1	1.15	1.20	1.24	1.23	1.78	2.43	550.0	1.55	1.40	1.38
705.1	1.14	1.20	1.23	1.26	1.82	2.58	600.0	1.54	1.40	1.39
780.0	1.15	1.17	1.20	1.31	1.92	2.65	650.0	1.54	1.40	1.39
855.0	1.26	1.25	1.26	1.34	1.99	2.72	700.0	1.54	1.40	1.40
930.0	1.49	1.46	1.45	1.37	1.97	2.68	750.0	1.51	1.40	1.39
1000.0	1.82	1.78	1.76	1.38	1.97	2.72	800.0	1.46	1.37	1.37
1005.0	1.84	1.78	1.76	1.39	2.01	2.68	850.0	1.44	1.35	1.35
1030.0	1.99	1.92	1.89	1.41	2.10	2.92	900.0	1.43	1.33	1.33
1060.0	2.16	2.06	2.03	1.44	2.16	2.92	950.0	1.43	1.33	1.32
1080.0	2.27	2.18	2.10	1.46	2.08	2.80	1000.0	1.43	1.34	1.33

## Typical Performance Curves

### Conversion Loss

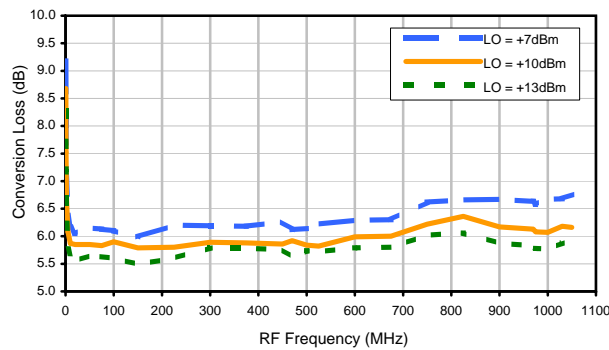

### LO-RF Isolation

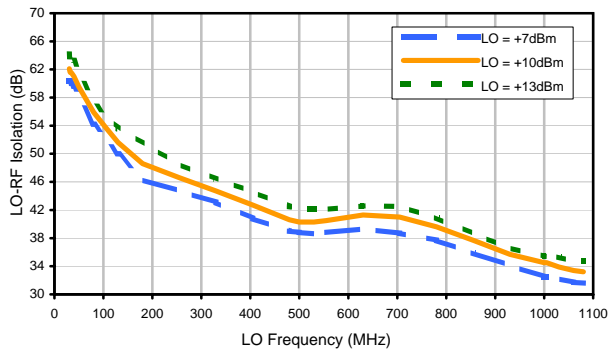

### LO-IF Isolation

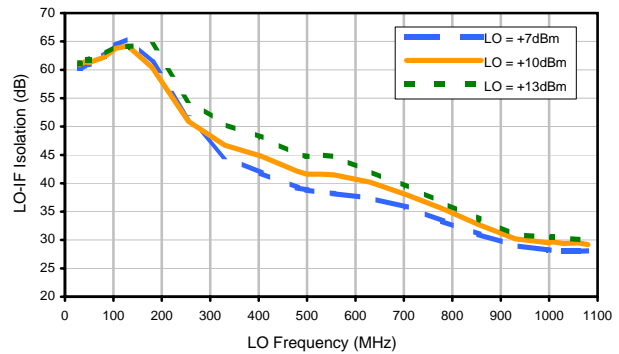

### RF VSWR

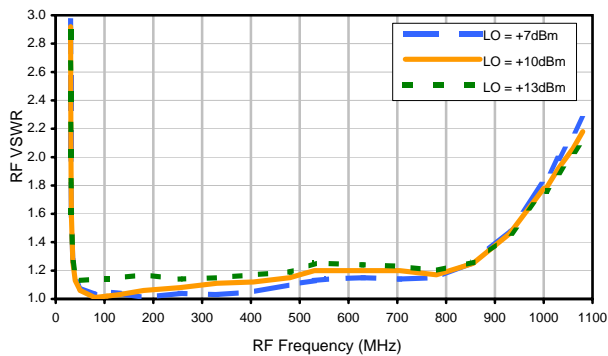

### LO VSWR

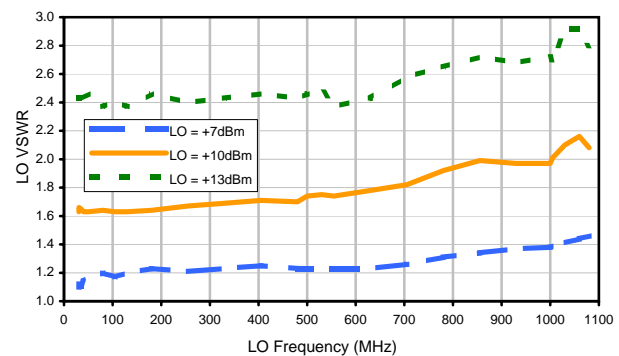

### IF VSWR

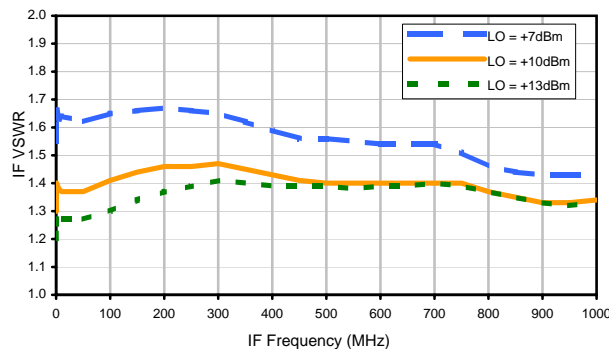

# Case Style

# CD

CD541  
CD542  
CD636  
CD637

## Outline Dimensions

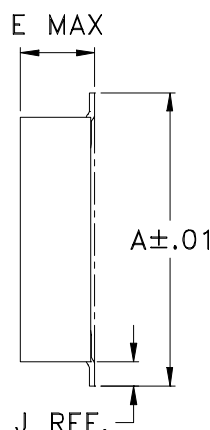
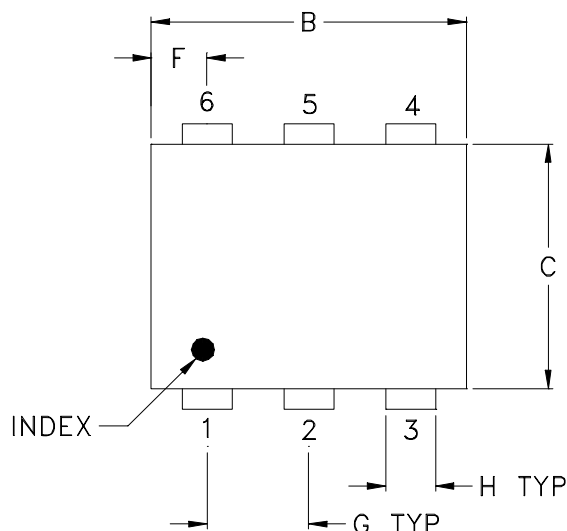

## PCB Land Pattern



Suggested Layout,  
Tolerance to be within  $\pm .002$

CASE#	A	B	C	D	E	F	G	H	J	K	L	WT, GRAM
CD541					.082 (2.08)							.15
CD542	.272 (6.91)	.310 (7.87)	.220 (5.58)	.100 (2.54)	.112 (2.84)	.055 (1.40)	.100 (2.54)	.030 (0.76)	.026 (0.66)	.065 (1.65)	.300 (7.62)	.20
CD636					.162 (4.11)							.25
CD637					.206 (5.23)							.40

Dimensions are in inches (mm). Tolerances: 2 Pl.  $\pm .01$ ; 3 Pl.  $\pm .005$

### Notes:

- Case material: Plastic.
- Termination finish:
  - For RoHS Case Styles: Tin plate over Nickel plate. All models, (+) suffix.
  - For RoHS-5 Case Styles: Tin-Lead plate. All models, no (+) suffix.

**Mini-Circuits®**

INTERNET <http://www.minicircuits.com>

P.O. Box 350166, Brooklyn, New York 11235-0003 (718) 934-4500 Fax (718) 332-4661

Distribution Centers NORTH AMERICA 800-654-7949 • 417-335-5935 • Fax 417-335-5945 • EUROPE 44-1252-832600 • Fax 44-1252-837010

Mini-Circuits ISO 9001 & ISO 14001 Certified

# Tape & Reel Packaging TR-F34



Tape Width, mm	Device Cavity Pitch, mm	Reel Size, inches	Devices per Reel see note	
16	12	7	Small quantity standard (see note)	20
				50
				100
				200
		13	Standard	500
				1000

Note: Availability of small reel quantity varies by model.  
Refer to pricing and availability on individual model dashboard.

Mini-Circuits carrier tape materials provide protection from ESD (Electro-Static Discharge) during handling and transportation. Tapes are static dissipative and comply with industry standards EIA-481/EIA-541.

Go to: [www.minicircuits.com/pages/pdfs/tape.pdf](http://www.minicircuits.com/pages/pdfs/tape.pdf)



INTERNET <http://www.minicircuits.com>

P.O. Box 350166, Brooklyn, New York 11235-0003 (718) 934-4500 Fax (718) 332-4661

Distribution Centers NORTH AMERICA 800-654-7949 • 417-335-5935 • Fax 417-335-5945 • EUROPE 44-1252-832600 • Fax 44-1252-837010

Mini-Circuits ISO 9001 & ISO 14001 Certified

THIRD ANGLE PROJECTION



REVISIONS

REV	ECN No.	DESCRIPTION	DATE	DR	AUTH
A	M101143	ADDED "gk" PIN CONNECTION, TT100 CASE STYLE & NOTE 2	10/10/05	MMG	DJ
B	M102713	ADDED "...WITH SMOBC"	01/17/06	MMG	IL
C	M108637	REMOVED "PIN 1", ADDED INDEX ON UNIT	12/01/06	MYG	FL

SUGGESTED MOUNTING CONFIGURATION  
FOR BH292, CD541/542/636/637, TT100/240 CASE  
STYLES, "gk", "ht", "hu", "nd", "w" PIN CONNECTIONS



- NOTES:** 1. TRACE WIDTH IS SHOWN FOR ROGERS R04350B WITH DIELECTRIC THICKNESS .030" ± .002"; COPPER: 1/2 OZ. EACH SIDE. FOR OTHER MATERIALS TRACE WIDTH MAY NEED TO BE MODIFIED.  
 2. BOTTOM SIDE OF THE PCB IS CONTINUOUS GROUND PLANE.

- DENOTES PCB COPPER LAYOUT WITH SMOBC (SOLDER MASK OVER BARE COPPER)
- DENOTES COPPER LAND PATTERN FREE OF SOLDER MASK

UNLESS OTHERWISE SPECIFIED	INITIALS	DATE
DIMENSIONS ARE IN INCHES	MMG	07/17/02
TOLERANCES ON:	WL	08/02/02
2 PL DECIMALS ±	DJ	08/05/02
3 PL DECIMALS ± .005		
ANGLES ±		
FRACTIONS ±		

**Mini-Circuits®** 13 Neptune Avenue  
 Brooklyn NY 11235

PL, gk/ht/hu/nd/w, BH292,  
 CD541/542/636/637, TT100/240, TB-03

SIZE A	CODE IDENT 15542	DRAWING NO: 98-PL-052	REV: C
FILE: 98PL052	SCALE: 8:1	SHEET: 1 OF 1	

Mini-Circuits®  
 THIS DOCUMENT AND ITS CONTENTS ARE THE PROPERTY OF MINI-CIRCUITS. EXCEPT FOR USE EXPRESSLY GRANTED, IN WRITING, TO ITS VENDORS, VENDEE AND THE UNITED STATES GOVERNMENT, MINI-CIRCUITS RESERVES ALL PROPRIETARY DESIGN, USE, MANUFACTURING AND REPRODUCTION RIGHTS THERETO. THESE CONTENTS SHALL NOT BE USED, DUPLICATED OR DISCLOSED TO ANY OUTSIDE PARTY, IN WHOLE OR IN PART, WITHOUT WRITTEN PERMISSION OF MINI-CIRCUITS.

THIRD ANGLE PROJECTION



REVISIONS

REV	ECN No.	DESCRIPTION	DATE	DR	AUTH
E	M119737	UPDATED PCB	10.08	MF	AD
F	M127659	UPDATED CARR	06.10	SW	SG
G	M127846	UPDATED SCHEMATIC DIAGRAM	06.10	SW	SG
H	M131840	UPDATED DWG	05.11	MF	AD



**NOTES:**

1. REFER TO -09 PAGE FOR ITEM DESCRIPTIONS.  
DESIGNATION NUMBERS ON -20 PAGE CORRESPOND TO THE NUMBERS ON -09 PAGE.
2. FOR TEXT HEIGHT & STYLE ON THE LABEL REFER TO: D3-G209.

UNLESS OTHERWISE SPECIFIED	INITIALS	DATE
DIMENSIONS ARE IN INCHES TOLERANCES ON: 2 PL DECIMALS ± 3 PL DECIMALS ± ANGLES ± FRACTIONS ±	DRAWN	S.WOLYNSKI 06.29.99
	CHECKED	SG 07.06.99
	APPROVED	MG 07.10.99

 **Mini-Circuits®** 13 Neptune Avenue  
Brooklyn NY 11235

TB,ADE,CD542/636,06MX01,50

 Mini-Circuits®  
THIS DOCUMENT AND ITS CONTENTS ARE THE PROPERTY OF MINI-CIRCUITS. EXCEPT FOR USE EXPRESSLY GRANTED, IN WRITING, TO ITS VENDORS, VENDEE AND THE UNITED STATES GOVERNMENT, MINI-CIRCUITS RESERVES ALL PROPRIETARY DESIGN, USE, MANUFACTURING AND REPRODUCTION RIGHTS THERETO. THESE CONTENTS SHALL NOT BE USED, DUPLICATED OR DISCLOSED TO ANY OUTSIDE PARTY, IN WHOLE OR IN PART, WITHOUT WRITTEN PERMISSION OF MINI-CIRCUITS.

SIZE A	CODE IDENT 15542	DRAWING NO: TB-03-20	REV: H
FILE: WTB-03	SCALE: 1.5:1	SHEET: 1 OF 2	

# Evaluation Board and Circuit

For Pin Connections and DUT Orientation Refer to  
Data Sheet of the DUT



TB-03

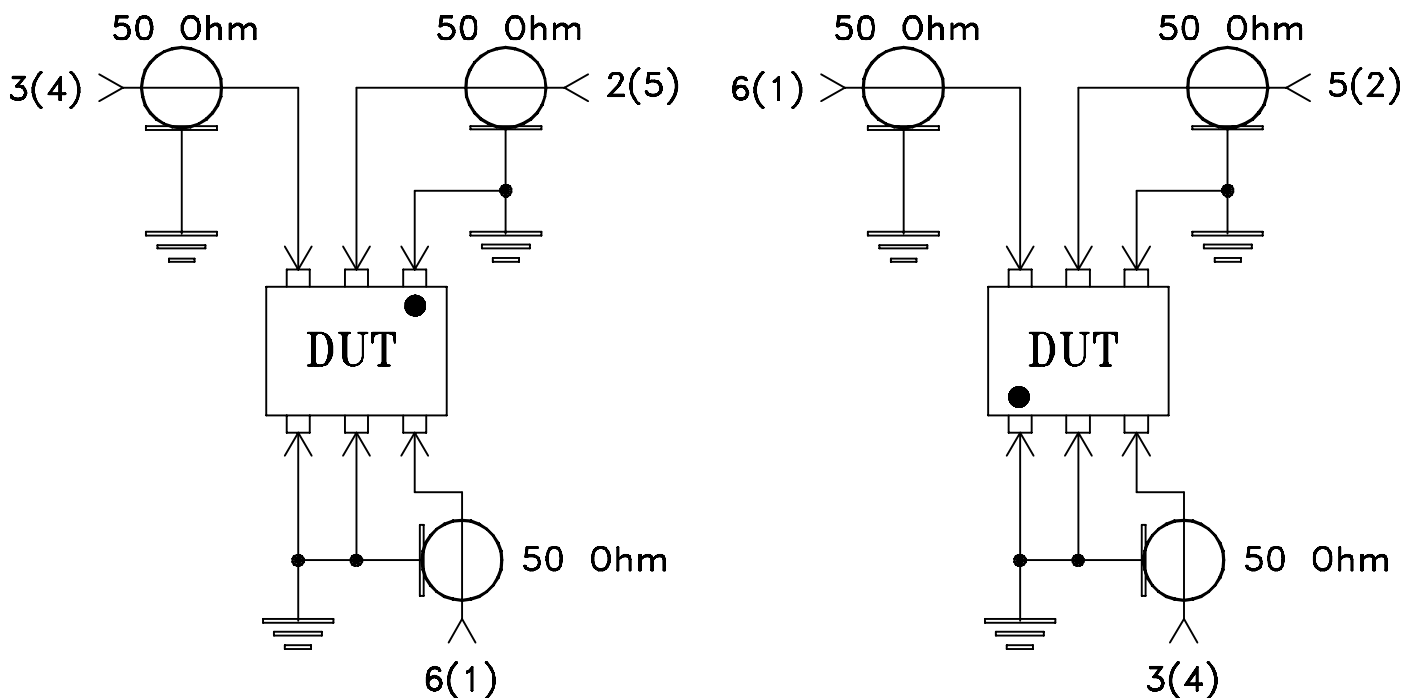

Schematic Diagram

## Notes:

1. 50 Ohm SMA Female connectors.
2. PCB Material: Rogers R04350 or equivalent,  
Dielectric Constant=3.5, Thickness=.030 inch.

 **Mini-Circuits®**



All Mini-Circuits products are manufactured under exacting quality assurance and control standards, and are capable of meeting published specifications after being subjected to any or all of the following physical and environmental test.

Specification	Test/Inspection Condition	Reference/Spec
Operating Temperature	-40° to 85°C Ambient Environment	Individual Model Data Sheet
Storage Temperature	-55° to 100° C Ambient Environment	Individual Model Data Sheet
Humidity	90 to 95% RH, 240 hours, 50°C	MIL-STD-202, Method 103, Condition A, Except 50°C and end-point electrical test done within 12 hours
Thermal Shock	-55° to 100°C, 100 cycles	MIL-STD-202, Method 107, Condition A-3, except +100°C
Solder Reflow Heat	Sn-Pb Eutetic Process: 225°C peak Pb-Free Process 245° - 250°C peak	J-STD-020, Table 4-1, 4-2 and 5-2, Figure 5-1
Solderability	10X Magnification	J-STD-002, 95% Coverage
Vibration (High Frequency)	20g peak, 10-2000 Hz, 12 times in each of three perpendicular directions (total 36)	MIL-STD-202, Method 204, Condition D
Mechanical Shock	50g, 11 ms, 1/2-sine, 18 shocks: 3 each direction, each of 3 axes	MIL-STD-202, Method 213, Condition A
Marking Resistance to Solvents	Isopropyl alcohol + mineral spirits at 25°C; terpene defluxer at 25°C; distilled water + proylene glycol monomethyl ether + monoethanolamine at 63°C to 70°C	MIL-STD-202, Method 215