

Engineering Development Model

RF Transformer

ADT1-ED10105/5

Impedance Ratio : 1

Important Note

This model has been designed, built and tested in our engineering department. Performance data represents model capability. At present it is a non-catalog model. On request, we can supply a final specification sheet, part number and price/delivery information.



Please click "Back", and then click "Contact Us" for Applications support.

CASE STYLE : CD636

ELECTRICAL SPECIFICATIONS 50Ω @ +25°C					
Parameter		Min.	Typ.	Max.	Units
Frequency		200		1150	MHz
Insertion Loss *	3 dB Bandwidth		200 - 1150		MHz
	2 dB Bandwidth		250 - 1150		MHz
	1 dB Bandwidth		325 - 1075		MHz

Note:

* Insertion Loss is referenced to mid-band loss, 1.58dB typ.

MAXIMUM RATINGS	
Operating Temperature	-20°C to 85°C
Storage Temperature	-55°C to 100°C
RF Power	0.25 W
DC Current	30 mA

Configuration : C

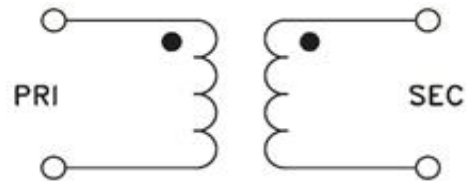

PIN CONNECTIONS	
PRIMARY DOT	3
PRIMARY	1
SECONDARY DOT	4
SECONDARY	6
NOT USED	2,5

RF Transformer

ADT1-ED10105/5

Typical Performance Data

FREQUENCY (MHz)	INSERTION LOSS (dB)	RETURN LOSS (dB)
200.00	3.14	3.26
225.00	2.78	3.68
250.00	2.50	4.07
275.00	2.28	4.41
300.00	2.14	4.72
325.00	2.02	4.97
350.00	1.89	5.20
375.00	1.81	5.40
400.00	1.77	5.56
425.00	1.72	5.71
450.00	1.65	5.83
475.00	1.63	5.92
500.00	1.63	5.99
525.00	1.60	6.06
550.00	1.58	6.11
575.00	1.60	6.16
600.00	1.60	6.17
625.00	1.59	6.20
650.00	1.60	6.20
675.00	1.63	6.20
700.00	1.63	6.19
725.00	1.64	6.19
750.00	1.67	6.16
775.00	1.68	6.14
800.00	1.73	6.13
825.00	1.75	6.11
850.00	1.73	6.09
875.00	1.77	6.06
900.00	1.86	6.04
925.00	1.86	6.03
950.00	1.81	6.02
975.00	1.88	5.99
1000.00	2.01	5.98
1025.00	1.99	5.96
1050.00	1.92	5.95
1075.00	2.01	5.95
1100.00	2.12	5.95
1125.00	2.10	5.95
1150.00	2.08	5.95

Typical Performance Curves

Insertion Loss

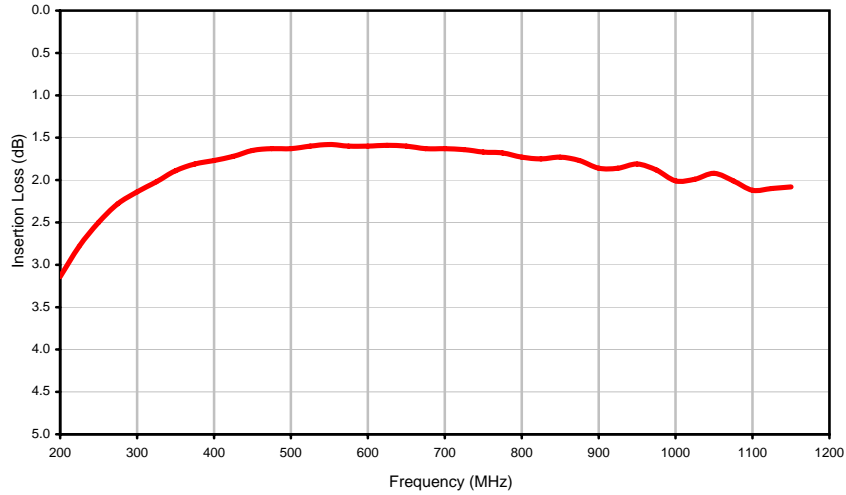

Return Loss

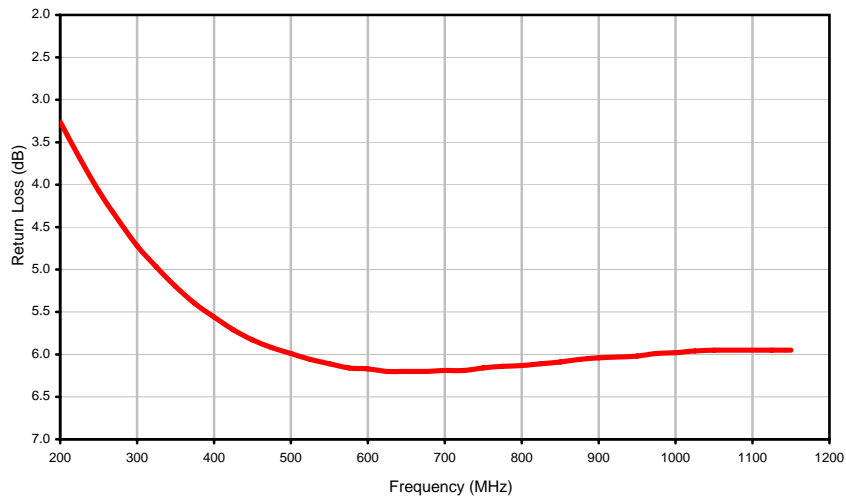

Case Style

CD

CD541
CD542
CD636
CD637

Outline Dimensions

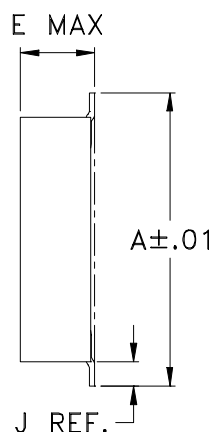

PCB Land Pattern



Suggested Layout,
Tolerance to be within $\pm .002$

CASE#	A	B	C	D	E	F	G	H	J	K	L	WT, GRAM
CD541					.082 (2.08)							.15
CD542	.272 (6.91)	.310 (7.87)	.220 (5.58)	.100 (2.54)	.112 (2.84)	.055 (1.40)	.100 (2.54)	.030 (0.76)	.026 (0.66)	.065 (1.65)	.300 (7.62)	.20
CD636					.162 (4.11)							.25
CD637					.206 (5.23)							.40

Dimensions are in inches (mm). Tolerances: 2 Pl. $\pm .01$; 3 Pl. $\pm .005$

Notes:

- Case material: Plastic.
- Termination finish:
 - For RoHS Case Styles: Tin plate over Nickel plate. All models, (+) suffix.
 - For RoHS-5 Case Styles: Tin-Lead plate. All models, no (+) suffix.

Mini-Circuits®

INTERNET <http://www.minicircuits.com>

P.O. Box 350166, Brooklyn, New York 11235-0003 (718) 934-4500 Fax (718) 332-4661

Distribution Centers NORTH AMERICA 800-654-7949 • 417-335-5935 • Fax 417-335-5945 • EUROPE 44-1252-832600 • Fax 44-1252-837010

Mini-Circuits ISO 9001 & ISO 14001 Certified

Tape & Reel Packaging TR-F34



Tape Width, mm	Device Cavity Pitch, mm	Reel Size, inches	Devices per Reel see note	
16	12	7	Small quantity standard (see note)	20
				50
				100
				200
		13	Standard	500
				1000

Note: Availability of small reel quantity varies by model.
Refer to pricing and availability on individual model dashboard.

Mini-Circuits carrier tape materials provide protection from ESD (Electro-Static Discharge) during handling and transportation. Tapes are static dissipative and comply with industry standards EIA-481/EIA-541.

Go to: www.minicircuits.com/pages/pdfs/tape.pdf



INTERNET <http://www.minicircuits.com>

P.O. Box 350166, Brooklyn, New York 11235-0003 (718) 934-4500 Fax (718) 332-4661

Distribution Centers NORTH AMERICA 800-654-7949 • 417-335-5935 • Fax 417-335-5945 • EUROPE 44-1252-832600 • Fax 44-1252-837010

Mini-Circuits ISO 9001 & ISO 14001 Certified

Evaluation Board and Circuit

For Pin Connections refer to Data Sheet of the DUT

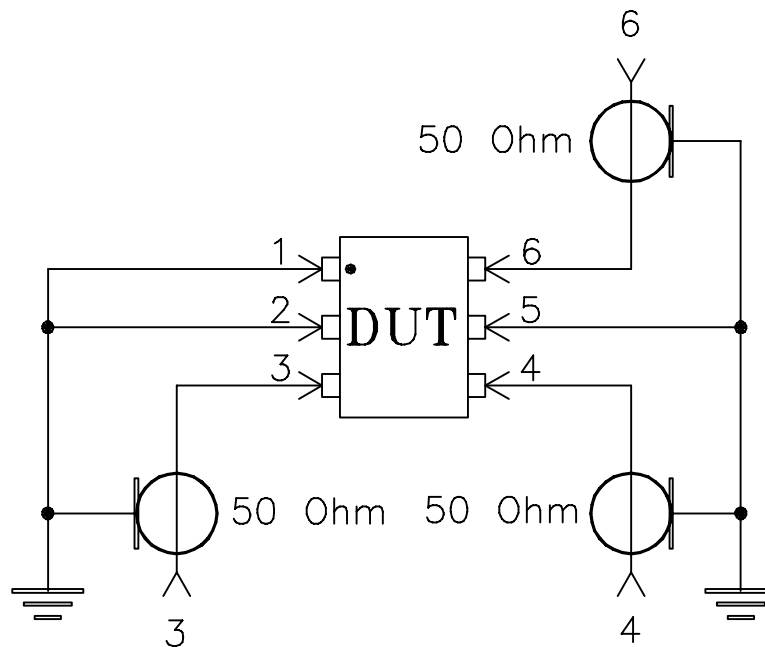
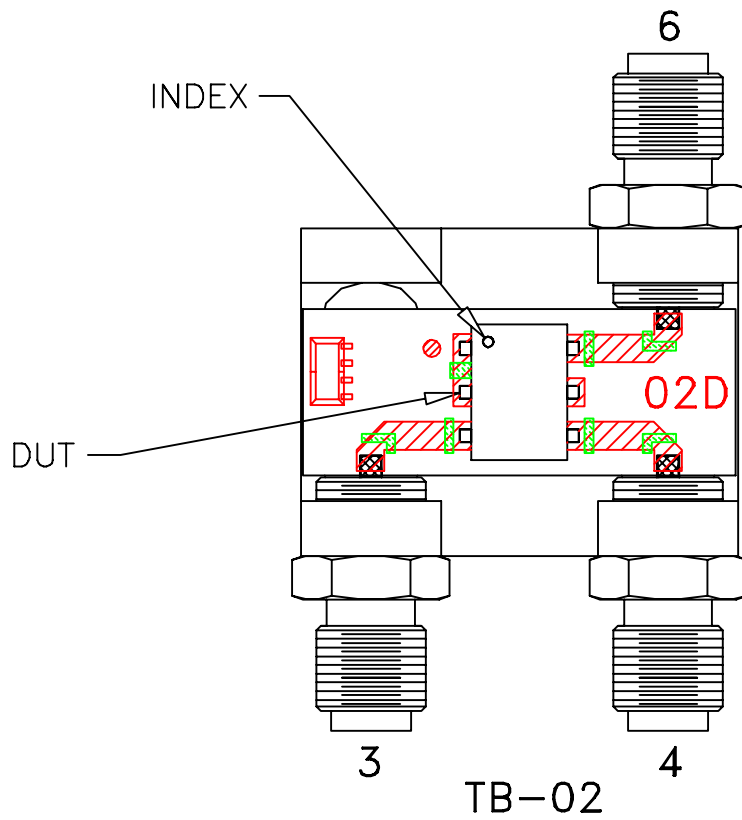

Schematic Diagram

Notes:

1. SMA Female connectors.
2. PCB Material: Rogers R04350 or equivalent,
Dielectric Constant=3.5, Thickness=.030 inch.

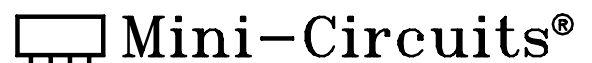

All Mini-Circuits products are manufactured under exacting quality assurance and control standards, and are capable of meeting published specifications after being subjected to any or all of the following physical and environmental test.

Specification	Test/Inspection Condition	Reference/Spec
Operating Temperature	-20° to 85°C Ambient Environment	Individual Model Data Sheet
Storage Temperature	-55° to 100° C Ambient Environment	Individual Model Data Sheet
Humidity	90 to 95% RH, 240 hours, 50°C	MIL-STD-202, Method 103, Condition A, Except 50°C and end-point electrical test done within 12 hours
Thermal Shock	-55° to 100°C, 100 cycles	MIL-STD-202, Method 107, Condition A-3, except +100°C
Solder Reflow Heat	Sn-Pb Eutetic Process: 225°C peak Pb-Free Process 245° - 250°C peak	J-STD-020, Table 4-1, 4-2 and 5-2, Figure 5-1
Solderability	10X Magnification	J-STD-002, 95% Coverage
Vibration (High Frequency)	20g peak, 10-2000 Hz, 12 times in each of three perpendicular directions (total 36)	MIL-STD-202, Method 204, Condition D
Mechanical Shock	50g, 11 ms, 1/2-sine, 18 shocks: 3 each direction, each of 3 axes	MIL-STD-202, Method 213, Condition A
Marking Resistance to Solvents	Isopropyl alcohol + mineral spirits at 25°C; terpene defluxer at 25°C; distilled water + proylene glycol monomethyl ether + monoethanolamine at 63°C to 70°C	MIL-STD-202, Method 215