

Engineering Development Model

RF Transformer

ADT1.5-ED7491B

Impedance Ratio : 1.5

Important Note

This model has been designed, built and tested in our engineering department. Performance data represents model capability. At present it is a non-catalog model. On request, we can supply a final specification sheet, part number and price/delivery information.



CASE STYLE : CD542

Please click "Back", and then click "Contact Us" for Applications support.

ELECTRICAL SPECIFICATIONS 50Ω @ +25°C					
Parameter		Min.	Typ.	Max.	Units
Frequency		2		450	MHz
Insertion Loss *	3 dB Bandwidth		2 - 450		MHz
	2 dB Bandwidth		2 - 450		MHz
	1 dB Bandwidth		2 - 300		MHz

Notes:

* Insertion Loss is referenced to mid-band loss, 0.30dB typ.

MAXIMUM RATINGS	
Operating Temperature	-40°C to 85°C
Storage Temperature	-55°C to 100°C
RF Power	0.25 W
DC Current	30 mA

Configuration : A

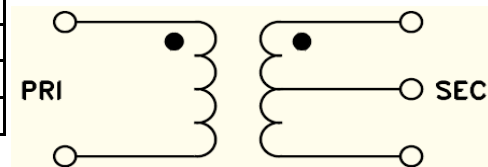

PIN CONNECTIONS	
PRIMARY DOT	1
PRIMARY	3
SECONDARY DOT	4
SECONDARY	6
SECONDARY CT	2
NOT USED	5

RF Transformer

ADT1.5-ED7491B

Typical Performance Data

FREQUENCY (MHz)	AVERAGE INSERTION LOSS (dB)	INPUT RETURN LOSS (dB)	AMPLITUDE UNBALANCE (dB)	PHASE UNBALANCE (deg.)
0.30	0.95	10.89	0.03	0.09
0.50	0.70	14.22	0.04	0.12
0.70	0.63	16.08	0.05	0.07
1.00	0.58	17.68	0.05	0.02
2.00	0.48	20.05	0.05	0.02
3.00	0.41	21.37	0.05	0.07
4.00	0.36	22.30	0.04	0.12
5.00	0.33	22.98	0.04	0.14
10.00	0.35	24.47	0.04	0.49
20.00	0.30	24.90	0.02	0.33
40.00	0.32	24.41	0.02	0.12
60.00	0.35	23.44	0.01	0.05
80.00	0.38	22.37	0.00	0.20
100.00	0.40	21.29	0.01	0.36
120.00	0.43	20.28	0.02	0.51
140.00	0.46	19.34	0.03	0.65
160.00	0.48	18.46	0.05	0.79
180.00	0.51	17.66	0.06	0.94
200.00	0.54	16.91	0.08	1.08
220.00	0.56	16.23	0.10	1.22
240.00	0.59	15.58	0.13	1.36
260.00	0.62	15.00	0.15	1.48
280.00	0.65	14.45	0.18	1.61
300.00	0.69	13.94	0.21	1.74
320.00	0.72	13.46	0.24	1.87
340.00	0.76	13.02	0.27	2.02
360.00	0.79	12.59	0.31	2.16
380.00	0.83	12.20	0.35	2.29
400.00	0.87	11.83	0.39	2.44
425.00	0.92	11.39	0.44	2.64
450.00	0.97	10.99	0.50	2.83
475.00	1.03	10.61	0.55	3.04
500.00	1.08	10.26	0.62	3.27
525.00	1.14	9.93	0.68	3.50
550.00	1.20	9.62	0.76	3.72



P.O. Box 350186, Brooklyn, New York 11235-0003 (718) 934-4500 Fax (718) 332-4861 For detailed performance specs & shopping online see Mini-Circuits web site



The Design Engineers Search Engine Provides ACTUAL Data Instantly From MINI-CIRCUITS At: www.minicircuits.com

RF/MICROWAVE COMPONENTS

REV. X1

ADT1.5-ED7491B

11/20/2007

PAGE 1 OF 1

RF Transformer

ADT1.5-ED7491B

Typical Performance Data

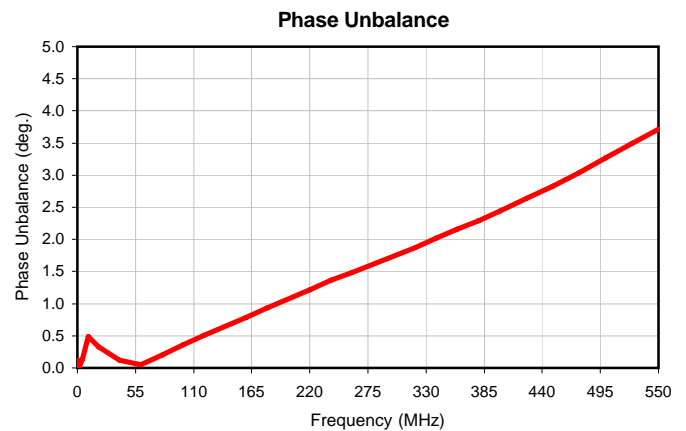
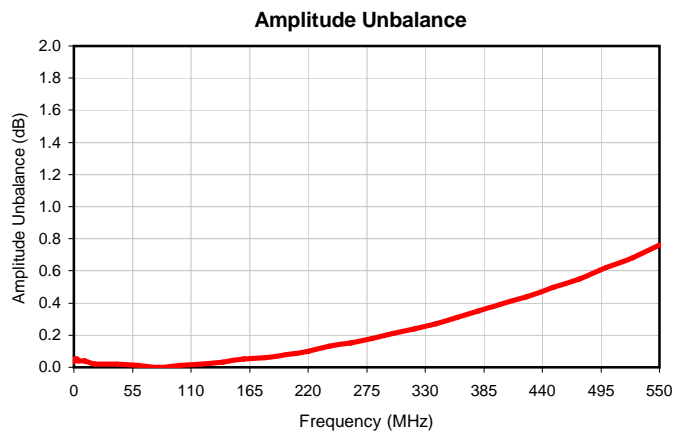
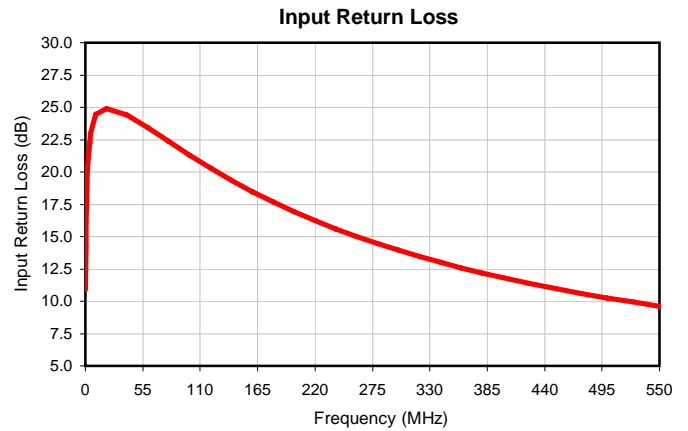
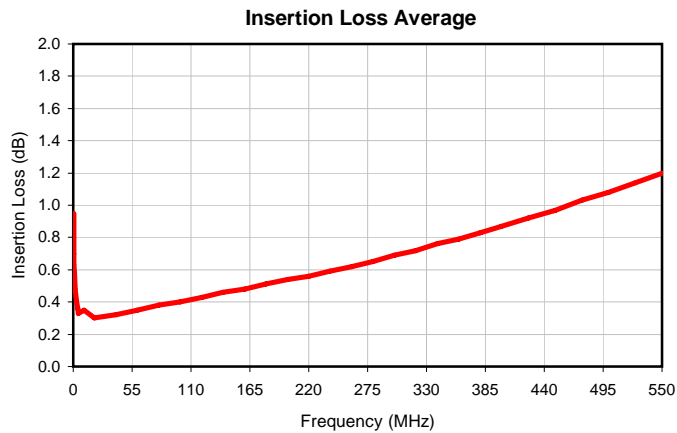

Case Style

CD

CD541
CD542
CD636
CD637

Outline Dimensions



PCB Land Pattern



Suggested Layout,
Tolerance to be within $\pm .002$

CASE#	A	B	C	D	E	F	G	H	J	K	L	WT, GRAM
CD541					.082 (2.08)							.15
CD542	.272 (6.91)	.310 (7.87)	.220 (5.58)	.100 (2.54)	.112 (2.84)	.055 (1.40)	.100 (2.54)	.030 (0.76)	.026 (0.66)	.065 (1.65)	.300 (7.62)	.20
CD636					.162 (4.11)							.25
CD637					.206 (5.23)							.40

Dimensions are in inches (mm). Tolerances: 2 Pl. $\pm .01$; 3 Pl. $\pm .005$

Notes:

- Case material: Plastic.
- Termination finish:
 - For RoHS Case Styles: Tin plate over Nickel plate. All models, (+) suffix.
 - For RoHS-5 Case Styles: Tin-Lead plate. All models, no (+) suffix.

Mini-Circuits

INTERNET <http://www.minicircuits.com>

P.O. Box 350166, Brooklyn, New York 11235-0003 (718) 934-4500 Fax (718) 332-4661

Distribution Centers NORTH AMERICA 800-654-7949 • 417-335-5935 • Fax 417-335-5945 • EUROPE 44-1252-832600 • Fax 44-1252-837010

Mini-Circuits ISO 9001 & ISO 14001 Certified

Tape & Reel Packaging TR-F34



Tape Width, mm	Device Cavity Pitch, mm	Reel Size, inches	Devices per Reel see note	
16	12	7	Small quantity standard (see note)	20
				50
				100
				200
		13	Standard	500
				1000

Note: Availability of small reel quantity varies by model.
Refer to pricing and availability on individual model dashboard.

Mini-Circuits carrier tape materials provide protection from ESD (Electro-Static Discharge) during handling and transportation. Tapes are static dissipative and comply with industry standards EIA-481/EIA-541.

Go to: www.minicircuits.com/pages/pdfs/tape.pdf



INTERNET <http://www.minicircuits.com>

P.O. Box 350166, Brooklyn, New York 11235-0003 (718) 934-4500 Fax (718) 332-4661

Distribution Centers NORTH AMERICA 800-654-7949 • 417-335-5935 • Fax 417-335-5945 • EUROPE 44-1252-832600 • Fax 44-1252-837010

Mini-Circuits ISO 9001 & ISO 14001 Certified

Evaluation Board and Circuit

For Pin Connections refer to Data Sheet of the DUT

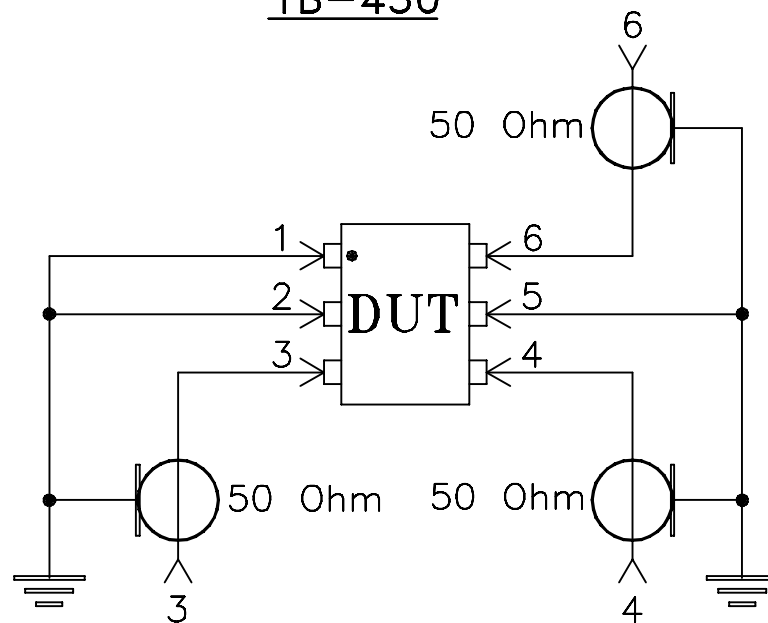
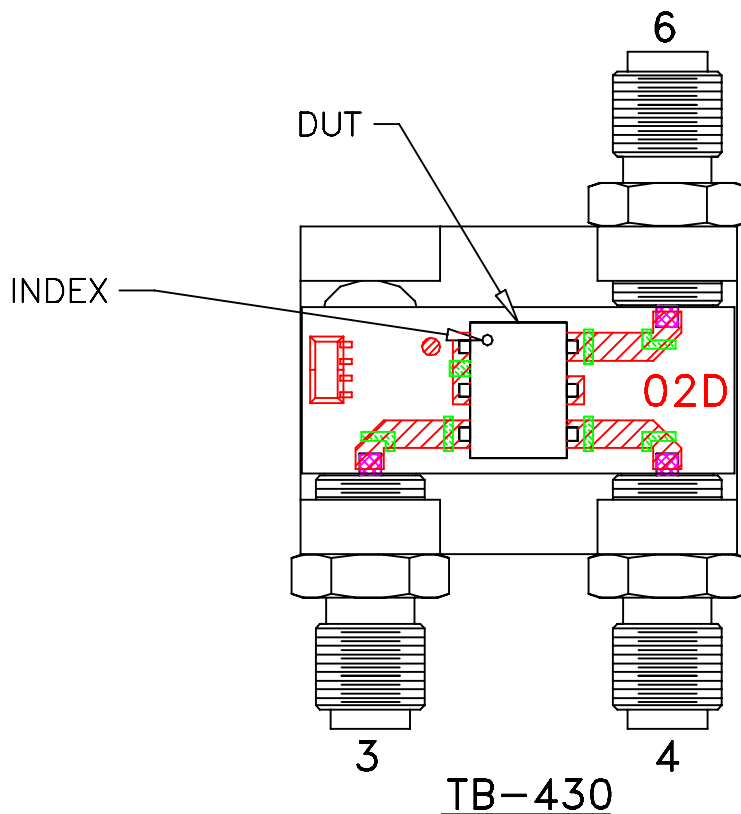

Schematic Diagram

Notes:

1. SMA Female connectors.
2. PCB Material: Rogers R04350 or equivalent, Dielectric Constant=3.5, Thickness=.030 inch.
3. Must use ENA/PNA type agilent's network analyzers with impedance conversion option to convert ports to appropriate impedances.

 Mini-Circuits®

All Mini-Circuits products are manufactured under exacting quality assurance and control standards, and are capable of meeting published specifications after being subjected to any or all of the following physical and environmental test.

Specification	Test/Inspection Condition	Reference/Spec
Operating Temperature	-40° to 85°C Ambient Environment	Individual Model Data Sheet
Storage Temperature	-55° to 100° C Ambient Environment	Individual Model Data Sheet
Humidity	90 to 95% RH, 240 hours, 50°C	MIL-STD-202, Method 103, Condition A, Except 50°C and end-point electrical test done within 12 hours
Thermal Shock	-55° to 100°C, 100 cycles	MIL-STD-202, Method 107, Condition A-3, except +100°C
Solder Reflow Heat	Sn-Pb Eutetic Process: 225°C peak Pb-Free Process 245° - 250°C peak	J-STD-020, Table 4-1, 4-2 and 5-2, Figure 5-1
Solderability	10X Magnification	J-STD-002, 95% Coverage
Vibration (High Frequency)	20g peak, 10-2000 Hz, 12 times in each of three perpendicular directions (total 36)	MIL-STD-202, Method 204, Condition D
Mechanical Shock	50g, 11 ms, 1/2-sine, 18 shocks: 3 each direction, each of 3 axes	MIL-STD-202, Method 213, Condition A
Marking Resistance to Solvents	Isopropyl alcohol + mineral spirits at 25°C; terpene defluxer at 25°C; distilled water + proylene glycol monomethyl ether + monoethanolamine at 63°C to 70°C	MIL-STD-202, Method 215