

Surface Mount

# RF Transformer

## ADT4-1WT

50Ω 2 to 775 MHz



Generic photo used for illustration purposes only

CASE STYLE: CD542

### Maximum Ratings

Operating Temperature	-20°C to 85°C
Storage Temperature	-55°C to 100°C
RF Power	0.25W
DC Current	30mA

Permanent damage may occur if any of these limits are exceeded.

### Pin Connections

PRIMARY DOT	3
PRIMARY	1
SECONDARY DOT	4
SECONDARY	6
SECONDARY CT	5
NOT USED	2

### Outline Drawing

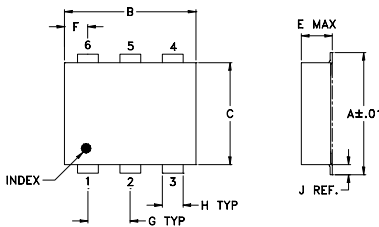

### PCB Land Pattern

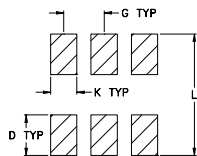

Suggested Layout,  
Tolerance to be within ±.002

### Outline Dimensions (inch/mm)

A	B	C	D	E	F	G
.272	.310	.220	.100	.112	.055	.100
6.91	7.87	5.59	2.54	2.84	1.40	2.54

H	J	K	L	wt
.030	.026	.065	.300	grams
0.76	0.66	1.65	7.62	0.20

Demo Board MCL P/N: TB-430

### Config. A

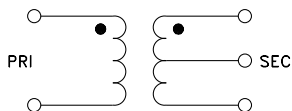

### Features

- excellent return loss, 20 dB typ. in dB bandwidth
- excellent amplitude unbalance, 0.1 dB typ. and phase unbalance, 1 deg. typ. in 1 dB bandwidth
- aqueous washable
- protected under US patent 6,133,525

### Applications

- impedance matching
- baluns

### Transformer Electrical Specifications

Ω RATIO (Secondary/Primary)	FREQUENCY (MHz)	INSERTION LOSS*			PHASE UNBALANCE (Deg.) Typ.		AMPLITUDE UNBALANCE (dB) Typ.	
		3 dB MHz	2 dB MHz	1 dB MHz	1 dB bandwidth	2 dB bandwidth	1 dB bandwidth	2 dB bandwidth
4	2-775	2-775	3-600	6-250	1	3	0.1	0.3

\* Insertion Loss is referenced to mid-band loss, 0.8 dB typ.

### Typical Performance Data

FREQUENCY (MHz)	INSERTION LOSS (dB)	INPUT R. LOSS (dB)	AMPLITUDE UNBALANCE (dB)	PHASE UNBALANCE (Deg.)
1.00	1.53	13.65	0.02	0.03
3.00	1.02	17.61	0.00	0.03
10.00	0.75	21.91	0.00	0.00
50.00	0.80	22.05	0.01	0.26
175.00	0.98	19.93	0.03	0.89
250.00	1.10	18.41	0.03	1.48
600.00	1.44	10.74	0.18	6.98
700.00	1.81	8.91	0.23	10.48
775.00	2.12	7.73	0.27	14.36
800.00	2.51	7.38	0.28	14.98

ADT4-1WT  
INSERTION LOSS

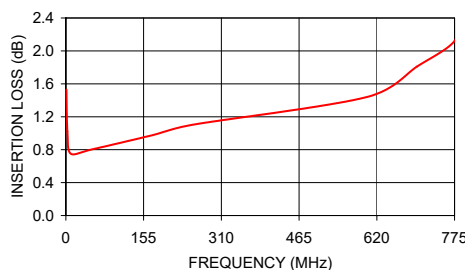

ADT4-1WT  
INPUT RETURN LOSS

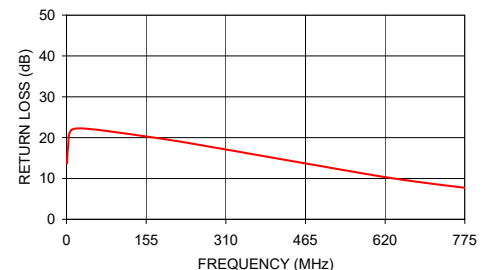

### Notes

- Performance and quality attributes and conditions not expressly stated in this specification document are intended to be excluded and do not form a part of this specification document.
- Electrical specifications and performance data contained in this specification document are based on Mini-Circuit's applicable established test performance criteria and measurement instructions.
- The parts covered by this specification document are subject to Mini-Circuits standard limited warranty and terms and conditions (collectively, "Standard Terms"); Purchasers of this part are entitled to the rights and benefits contained therein. For a full statement of the Standard Terms and the exclusive rights and remedies thereunder, please visit Mini-Circuits' website at [www.minicircuits.com/MCLStore/terms.jsp](http://www.minicircuits.com/MCLStore/terms.jsp)



## Typical Performance Data

FREQUENCY (MHz)	AVERAGE INSERTION LOSS (dB)	INPUT RETURN LOSS (dB)	AMPLITUDE UNBALANCE (dB)	PHASE UNBALANCE (deg)
1	1.53	13.65	0.02	0.03
3	1.02	17.61	0.00	0.03
10	0.75	21.91	0.00	0.00
50	0.80	22.05	0.01	0.26
175	0.98	19.93	0.03	0.89
250	1.10	18.41	0.03	1.48
600	1.44	10.74	0.18	6.98
700	1.81	8.91	0.23	10.48
775	2.12	7.73	0.27	14.36
800	2.51	7.38	0.28	14.98

## Typical Performance Curves

### Average Insertion Loss

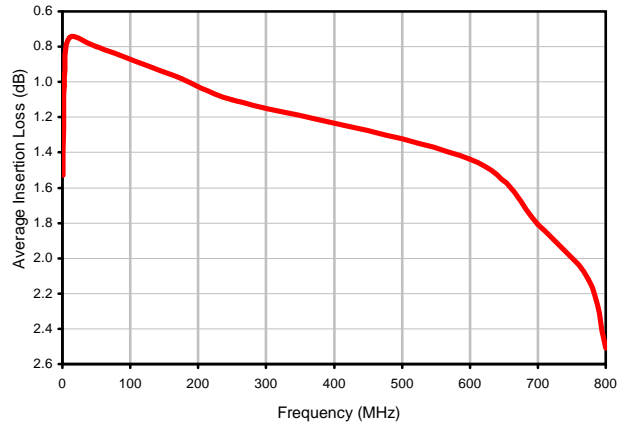

### Input Return Loss

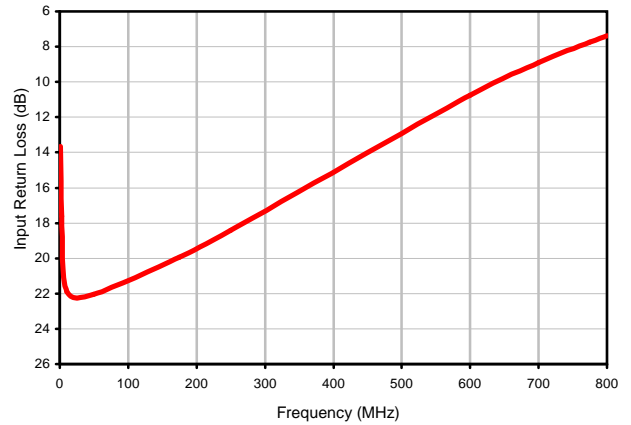

### Amplitude Unbalance

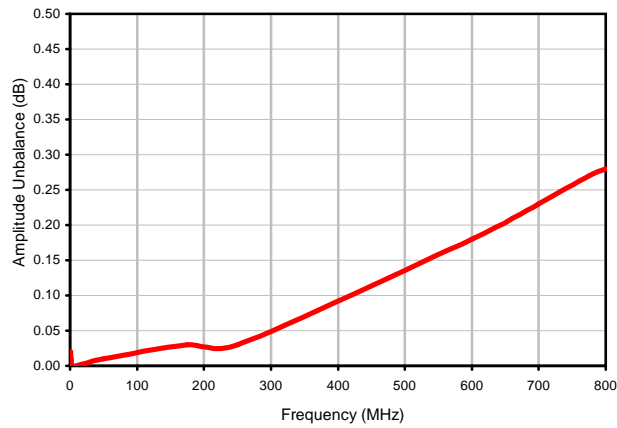

### Phase Unbalance

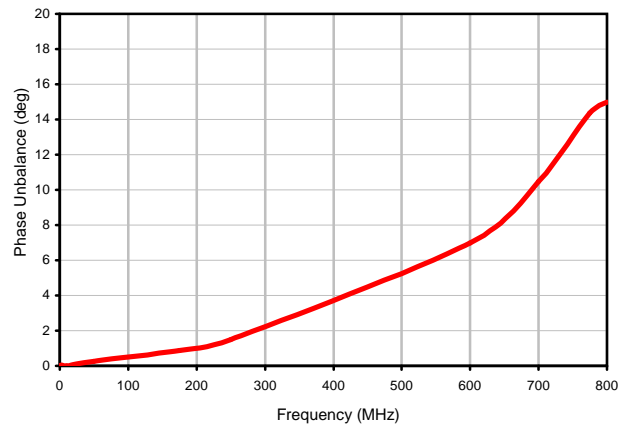

# Case Style

# CD

CD541  
CD542  
CD636  
CD637

## Outline Dimensions



## PCB Land Pattern



Suggested Layout,  
Tolerance to be within  $\pm .002$

CASE#	A	B	C	D	E	F	G	H	J	K	L	WT, GRAM
CD541					.082 (2.08)							.15
CD542	.272 (6.91)	.310 (7.87)	.220 (5.58)	.100 (2.54)	.112 (2.84)	.055 (1.40)	.100 (2.54)	.030 (0.76)	.026 (0.66)	.065 (1.65)	.300 (7.62)	.20
CD636					.162 (4.11)							.25
CD637					.206 (5.23)							.40

Dimensions are in inches (mm). Tolerances: 2 Pl.  $\pm .01$ ; 3 Pl.  $\pm .005$

### Notes:

- Case material: Plastic.
- Termination finish:
  - For RoHS Case Styles: Tin plate over Nickel plate. All models, (+) suffix.
  - For RoHS-5 Case Styles: Tin-Lead plate. All models, no (+) suffix.

**Mini-Circuits**<sup>®</sup>

INTERNET <http://www.minicircuits.com>

P.O. Box 350166, Brooklyn, New York 11235-0003 (718) 934-4500 Fax (718) 332-4661

Distribution Centers NORTH AMERICA 800-654-7949 • 417-335-5935 • Fax 417-335-5945 • EUROPE 44-1252-832600 • Fax 44-1252-837010

Mini-Circuits ISO 9001 & ISO 14001 Certified

# Tape & Reel Packaging TR-F34



Tape Width, mm	Device Cavity Pitch, mm	Reel Size, inches	Devices per Reel see note	
16	12	7	Small quantity standard (see note)	20
				50
			Standard	100
				200
		13	Standard	500
				1000

Note: Availability of small reel quantity varies by model.  
Refer to pricing and availability on individual model dashboard.

Mini-Circuits carrier tape materials provide protection from ESD (Electro-Static Discharge) during handling and transportation. Tapes are static dissipative and comply with industry standards EIA-481/EIA-541.

Go to: [www.minicircuits.com/pages/pdfs/tape.pdf](http://www.minicircuits.com/pages/pdfs/tape.pdf)



INTERNET <http://www.minicircuits.com>

P.O. Box 350166, Brooklyn, New York 11235-0003 (718) 934-4500 Fax (718) 332-4661

Distribution Centers NORTH AMERICA 800-654-7949 • 417-335-5935 • Fax 417-335-5945 • EUROPE 44-1252-832600 • Fax 44-1252-837010

Mini-Circuits ISO 9001 & ISO 14001 Certified

# Evaluation Board and Circuit

For Pin Connections refer to Data Sheet of the DUT

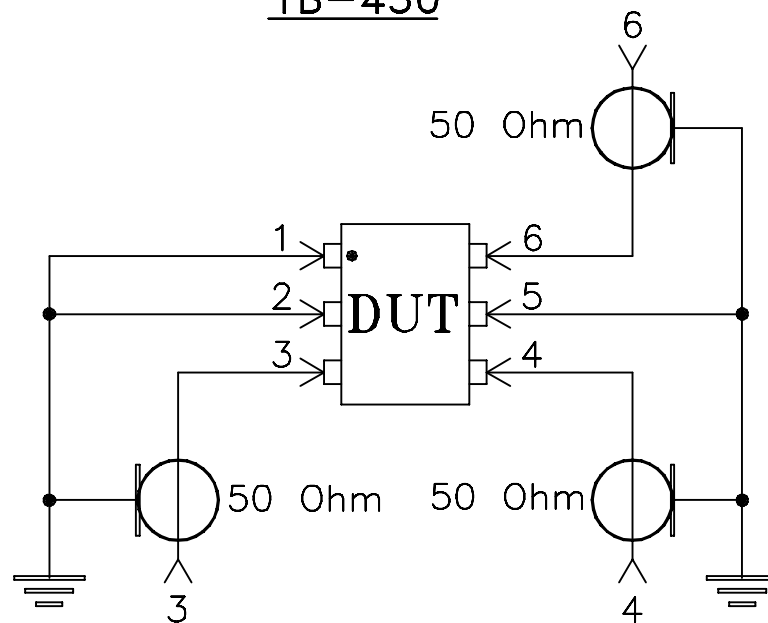
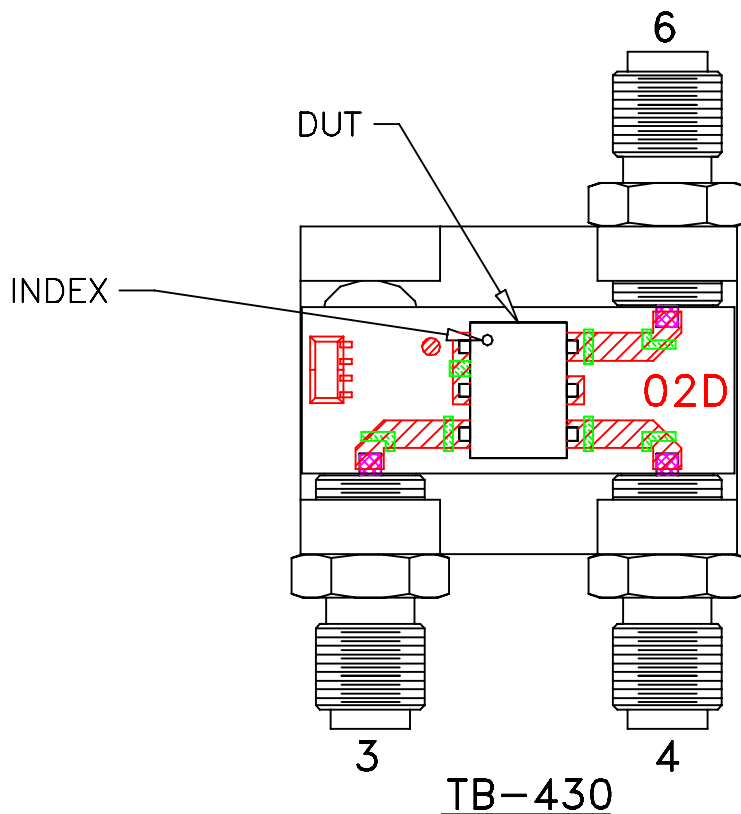

Schematic Diagram

## Notes:

1. SMA Female connectors.
2. PCB Material: Rogers R04350 or equivalent, Dielectric Constant=3.5, Thickness=.030 inch.
3. Must use ENA/PNA type agilent's network analyzers with impedance conversion option to convert ports to appropriate impedances.

 Mini-Circuits®

All Mini-Circuits products are manufactured under exacting quality assurance and control standards, and are capable of meeting published specifications after being subjected to any or all of the following physical and environmental test.

Specification	Test/Inspection Condition	Reference/Spec
Operating Temperature	-20° to 85°C Ambient Environment	Individual Model Data Sheet
Storage Temperature	-55° to 100° C Ambient Environment	Individual Model Data Sheet
Humidity	90 to 95% RH, 240 hours, 50°C	MIL-STD-202, Method 103, Condition A, Except 50°C and end-point electrical test done within 12 hours
Thermal Shock	-55° to 100°C, 100 cycles	MIL-STD-202, Method 107, Condition A-3, except +100°C
Solder Reflow Heat	Sn-Pb Eutetic Process: 225°C peak Pb-Free Process 245° - 250°C peak	J-STD-020, Table 4-1, 4-2 and 5-2, Figure 5-1
Solderability	10X Magnification	J-STD-002, 95% Coverage
Vibration (High Frequency)	20g peak, 10-2000 Hz, 12 times in each of three perpendicular directions (total 36)	MIL-STD-202, Method 204, Condition D
Mechanical Shock	50g, 11 ms, 1/2-sine, 18 shocks: 3 each direction, each of 3 axes	MIL-STD-202, Method 213, Condition A
Marking Resistance to Solvents	Isopropyl alcohol + mineral spirits at 25°C; terpene defluxer at 25°C; distilled water + proylene glycol monomethyl ether + monoethanolamine at 63°C to 70°C	MIL-STD-202, Method 215