

Surface Mount RF Transformer

ADTT1.5-1

50Ω 0.25 to 300 MHz



Generic photo used for illustration purposes only

CASE STYLE: CD636

Maximum Ratings

Operating Temperature	-20°C to 85°C
Storage Temperature	-55°C to 100°C
RF Power	0.25W
DC Current	30mA
*Permanent damage may occur if any of these limits are exceeded.	

Pin Connections

PRIMARY DOT	3
PRIMARY	1
PRIMARY CT	2
SECONDARY DOT	4
SECONDARY	6
SECONDARY CT	5

Outline Drawing

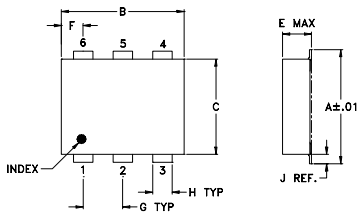

PCB Land Pattern

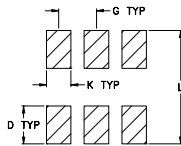

Suggested Layout,
Tolerance to be within ±.002

Outline Dimensions (inch)

A	B	C	D	E	F	G
.272	.310	.220	.100	.162	.055	.100
6.91	7.87	5.59	2.54	4.11	1.40	2.54
H	J	K	L	wt		
.030	.026	.065	.300	grams		
0.76	0.66	1.65	7.62	0.25		

Demo Board MCL P/N: TB-211

Config. B

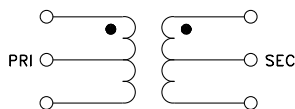

Features

- excellent return loss, 15 dB in 1 dB bandwidth
- excellent amplitude unbalance, 0.15 dB typ. and phase unbalance, 1 deg. typ. in 1 dB bandwidth
- aqueous washable
- protected under U.S. Patent 6,133,525

Applications

- impedance matching
- balanced amplifier

Transformer Electrical Specifications

Ω RATIO (Secondary/Primary)	FREQUENCY (MHz)	INSERTION LOSS*			PHASE UNBALANCE (Deg.) Typ.		AMPLITUDE UNBALANCE (dB) Typ.	
		3 dB MHz	2 dB MHz	1 dB MHz	1 dB bandwidth	2 dB bandwidth	1 dB bandwidth	2 dB bandwidth
1.5	0.25-300	0.25-300	0.3-175	0.5-100	1	2	0.15	0.3

* Insertion Loss is referenced to mid-band loss, 0.3 dB typ.

Typical Performance Data

FREQUENCY (MHz)	INSERTION LOSS (dB)	INPUT R. LOSS (dB)	AMPLITUDE UNBALANCE (dB)	PHASE UNBALANCE (Deg.)
0.20	0.29	17.11	0.07	0.08
0.60	0.30	26.04	0.10	0.00
1.00	0.29	29.04	0.07	0.04
5.00	0.23	32.13	0.07	0.04
10.00	0.23	29.83	0.08	0.19
40.00	0.33	20.68	0.08	0.72
50.00	0.38	18.96	0.11	0.94
80.00	0.47	15.23	0.18	1.45
100.00	0.53	13.49	0.25	1.81
300.00	1.87	5.87	1.59	6.47

ADTT1.5-1
INSERTION LOSS

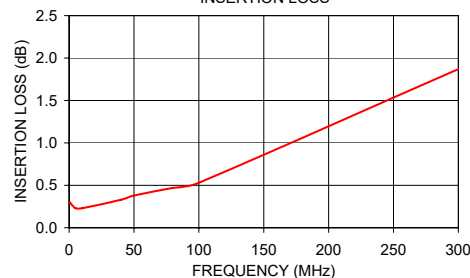

ADTT1.5-1
INPUT RETURN LOSS

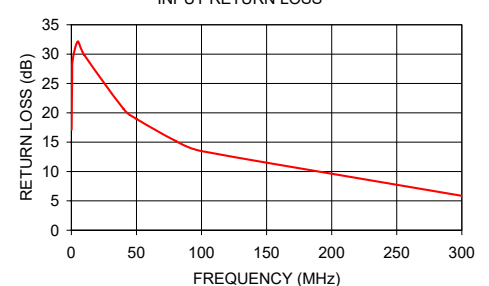

Notes

- Performance and quality attributes and conditions not expressly stated in this specification document are intended to be excluded and do not form a part of this specification document.
- Electrical specifications and performance data contained in this specification document are based on Mini-Circuit's applicable established test performance criteria and measurement instructions.
- The parts covered by this specification document are subject to Mini-Circuits standard limited warranty and terms and conditions (collectively, "Standard Terms"); Purchasers of this part are entitled to the rights and benefits contained therein. For a full statement of the Standard Terms and the exclusive rights and remedies thereunder, please visit Mini-Circuits' website at www.minicircuits.com/MCLStore/terms.jsp



Typical Performance Data

FREQUENCY (MHz)	AVERAGE INSERTION LOSS (dB)	INPUT RETURN LOSS (dB)	AMPLITUDE UNBALANCE (dB)	PHASE UNBALANCE (deg)
0.2	0.29	17.11	0.07	0.08
0.6	0.30	26.04	0.10	0.00
1.0	0.29	29.04	0.07	0.04
5.0	0.23	32.13	0.07	0.04
10.0	0.23	29.83	0.08	0.19
40.0	0.33	20.68	0.08	0.72
50.0	0.38	18.96	0.11	0.94
80.0	0.47	15.23	0.18	1.45
100.0	0.53	13.49	0.25	1.81
300.0	1.87	5.87	1.59	6.47

Typical Performance Curves

Average Insertion Loss

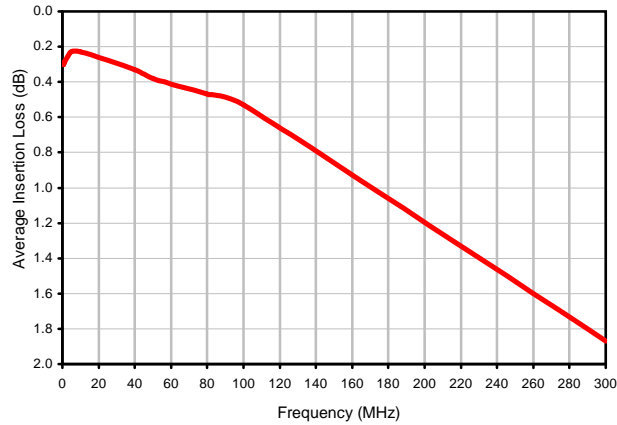

Input Return Loss

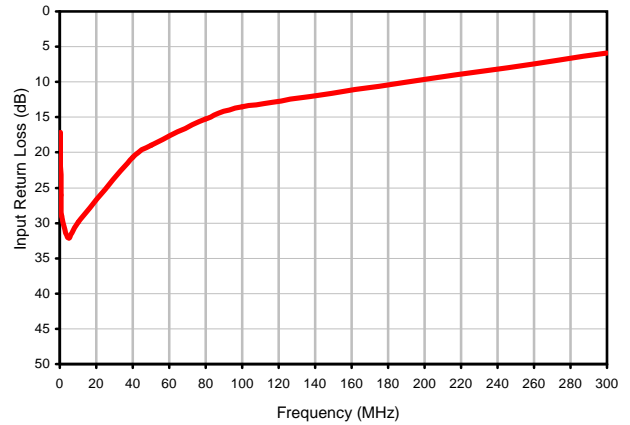

Amplitude Unbalance

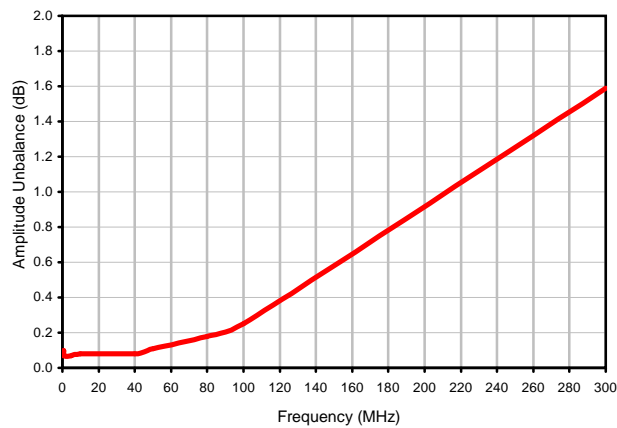

Phase Unbalance

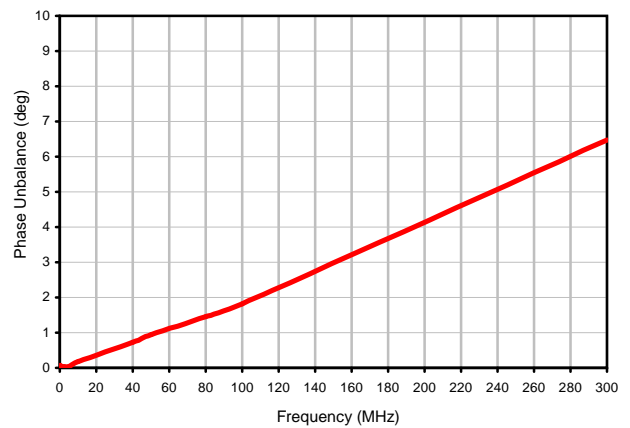

Case Style

CD

CD541
CD542
CD636
CD637

Outline Dimensions



PCB Land Pattern



Suggested Layout,
Tolerance to be within $\pm .002$

CASE#	A	B	C	D	E	F	G	H	J	K	L	WT, GRAM
CD541					.082 (2.08)							.15
CD542	.272 (6.91)	.310 (7.87)	.220 (5.58)	.100 (2.54)	.112 (2.84)	.055 (1.40)	.100 (2.54)	.030 (0.76)	.026 (0.66)	.065 (1.65)	.300 (7.62)	.20
CD636					.162 (4.11)							.25
CD637					.206 (5.23)							.40

Dimensions are in inches (mm). Tolerances: 2 Pl. $\pm .01$; 3 Pl. $\pm .005$

Notes:

- Case material: Plastic.
- Termination finish:
 - For RoHS Case Styles: Tin plate over Nickel plate. All models, (+) suffix.
 - For RoHS-5 Case Styles: Tin-Lead plate. All models, no (+) suffix.

Mini-Circuits®

INTERNET <http://www.minicircuits.com>

P.O. Box 350166, Brooklyn, New York 11235-0003 (718) 934-4500 Fax (718) 332-4661

Distribution Centers NORTH AMERICA 800-654-7949 • 417-335-5935 • Fax 417-335-5945 • EUROPE 44-1252-832600 • Fax 44-1252-837010

Mini-Circuits ISO 9001 & ISO 14001 Certified

Tape & Reel Packaging TR-F34



Tape Width, mm	Device Cavity Pitch, mm	Reel Size, inches	Devices per Reel see note	
16	12	7	Small quantity standard (see note)	20
				50
			100	
			200	
		13	Standard	500
				1000

Note: Availability of small reel quantity varies by model.
Refer to pricing and availability on individual model dashboard.

Mini-Circuits carrier tape materials provide protection from ESD (Electro-Static Discharge) during handling and transportation. Tapes are static dissipative and comply with industry standards EIA-481/EIA-541.

Go to: www.minicircuits.com/pages/pdfs/tape.pdf



INTERNET <http://www.minicircuits.com>

P.O. Box 350166, Brooklyn, New York 11235-0003 (718) 934-4500 Fax (718) 332-4661

Distribution Centers NORTH AMERICA 800-654-7949 • 417-335-5935 • Fax 417-335-5945 • EUROPE 44-1252-832600 • Fax 44-1252-837010

Mini-Circuits ISO 9001 & ISO 14001 Certified

Evaluation Board and Circuit

For Pin Connections refer to Data Sheet of the DUT

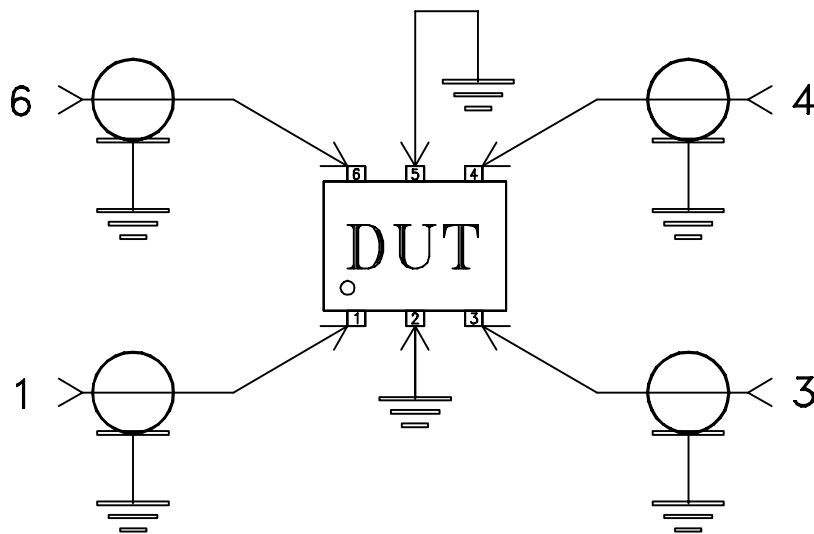
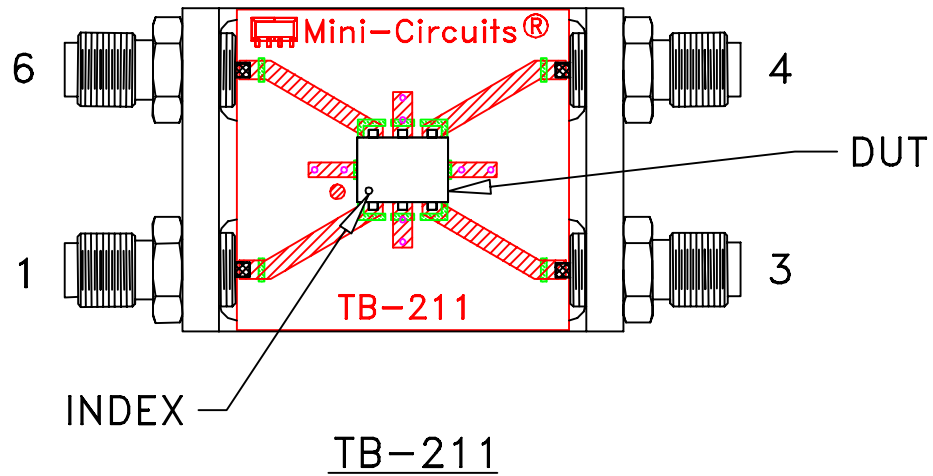

Schematic Diagram

Notes:

1. SMA Female connectors.
2. PCB Material: Rogers R04350 or equivalent,
Dielectric Constant=3.5, Thickness=.030 inch.

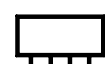
 Mini-Circuits®

All Mini-Circuits products are manufactured under exacting quality assurance and control standards, and are capable of meeting published specifications after being subjected to any or all of the following physical and environmental test.

Specification	Test/Inspection Condition	Reference/Spec
Operating Temperature	-20° to 85°C Ambient Environment	Individual Model Data Sheet
Storage Temperature	-55° to 100° C Ambient Environment	Individual Model Data Sheet
Humidity	90 to 95% RH, 240 hours, 50°C	MIL-STD-202, Method 103, Condition A, Except 50°C and end-point electrical test done within 12 hours
Thermal Shock	-55° to 100°C, 100 cycles	MIL-STD-202, Method 107, Condition A-3, except +100°C
Solder Reflow Heat	Sn-Pb Eutetic Process: 225°C peak Pb-Free Process 245° - 250°C peak	J-STD-020, Table 4-1, 4-2 and 5-2, Figure 5-1
Solderability	10X Magnification	J-STD-002, 95% Coverage
Vibration (High Frequency)	20g peak, 10-2000 Hz, 12 times in each of three perpendicular directions (total 36)	MIL-STD-202, Method 204, Condition D
Mechanical Shock	50g, 11 ms, 1/2-sine, 18 shocks: 3 each direction, each of 3 axes	MIL-STD-202, Method 213, Condition A
Marking Resistance to Solvents	Isopropyl alcohol + mineral spirits at 25°C; terpene defluxer at 25°C; distilled water + proylene glycol monomethyl ether + monoethanolamine at 63°C to 70°C	MIL-STD-202, Method 215