

Engineering Development Model

Active Mixer

AMCY-ED12679/1

Level 0 (LO Power 0 dBm)

Important Note

This model has been designed, built and tested in our engineering department. Performance data represents model capability. At present it is a non-catalog model. On request, we can supply a final specification sheet, part number and price/delivery information.



CASE STYLE : BJ293

Please click "Back", and then click "Contact Us" for Applications support.

ELECTRICAL SPECIFICATIONS 50Ω @ +25°C					
Parameter		Min.	Typ.	Max.	Units
Frequency	LO (fL to fU)	268		1310	MHz
	RF (fL to fU)	268		1310	MHz
	IF	161		177	MHz
Conversion Loss	Mid Band		7.1		dB
	Total Range		7.4		dB
LO-RF Isolation			19		dB
LO-IF Isolation			14		dB
Input IP3			+25		dBm
1 dB Compression			+15		dBm
DC Voltage			5		V
DC Current			90		mA

Note: mid band = [2fL to fU/2]

MAXIMUM RATINGS	
Operating Temperature	-40°C to 85°C
Storage Temperature	-55°C to +100°C

PIN CONNECTIONS	
LO	1
RF	5
IF	3
DC	7
GROUND	2,4,6,8



P.O. Box 350188, Brooklyn, New York 11235-0000 (718) 934-4500 Fax (718) 332-4851 For detailed performance specs & shopping online see Mini-Circuits web site



The Design Engineers Search Engine Provides ACTUAL Data Instantly From MIN-CIRCUITS At: www.minicircuits.com

IF/RF MICROWAVE COMPONENTS



REV. X2
AMCY-ED12679/1
12/5/2008
Page 1 of 1

Frequency Mixer

AMCY-ED12679/1

Typical Performance Data

RF (IN) (MHz)	LO (MHz)	CONVERSION LOSS IF FIXED @IF(OUT)=169MHz (dB)			RF (IN) (MHz)	LO (MHz)	IP3 INPUT (dBm)			RF (IN) (MHz)	LO (MHz)	COMPRESSION @RF IN=15dBm (dB)		
		@LO (dBm)					@LO (dBm)					@LO (dBm)		
		-3	0	+3			-3	0	+3			-3	0	+3
190.1	359.1	11.28	11.04	13.34	190.1	359.1	13.54	14.96	18.00	190.1	359.1	1.90	1.73	0.56
220.1	389.1	9.74	9.14	9.30	220.1	389.1	16.30	17.73	22.09	220.1	389.1	1.91	1.13	0.62
250.1	419.1	8.84	8.29	8.58	250.1	419.1	17.55	18.71	22.81	250.1	419.1	2.15	1.35	0.69
280.1	449.1	7.91	7.62	8.81	280.1	449.1	18.52	20.88	22.16	280.1	449.1	2.35	1.38	0.23
310.1	479.1	7.58	7.73	8.84	310.1	479.1	20.48	23.88	20.46	310.1	479.1	1.56	1.06	0.62
340.1	509.1	7.12	7.69	8.08	340.1	509.1	20.63	20.07	19.58	340.1	509.1	1.65	1.40	1.02
370.1	539.1	7.02	7.22	7.11	370.1	539.1	21.29	25.74	27.33	370.1	539.1	1.32	0.84	0.71
400.1	569.1	6.90	7.16	7.28	400.1	569.1	23.14	27.74	26.61	400.1	569.1	0.97	0.50	0.56
430.1	599.1	6.90	7.22	7.32	430.1	599.1	23.52	25.26	21.12	430.1	599.1	0.78	0.44	0.96
460.1	629.1	6.99	7.36	7.70	460.1	629.1	24.77	22.11	18.93	460.1	629.1	0.62	0.54	0.96
500.1	669.1	7.06	7.31	8.02	500.1	669.1	31.61	20.70	20.61	500.1	669.1	0.57	0.56	0.56
530.1	699.1	7.36	8.07	8.74	530.1	699.1	22.65	24.28	28.15	530.1	699.1	0.87	0.61	0.46
570.1	739.1	7.20	7.18	7.19	570.1	739.1	28.79	30.10	31.36	570.1	739.1	0.40	0.29	0.29
600.1	769.1	7.10	7.12	7.12	600.1	769.1	29.93	31.36	32.72	600.1	769.1	0.44	0.30	0.23
640.1	809.1	6.77	6.76	6.82	640.1	809.1	27.48	31.59	30.40	640.1	809.1	0.43	0.30	0.31
670.1	839.1	6.57	6.51	6.55	670.1	839.1	27.03	29.20	30.60	670.1	839.1	0.47	0.36	0.37
710.1	879.1	6.83	6.78	6.84	710.1	879.1	25.51	25.38	25.49	710.1	879.1	0.50	0.51	0.46
740.1	909.1	6.96	6.92	6.89	740.1	909.1	26.40	27.91	27.53	740.1	909.1	0.08	0.09	0.11
780.1	949.1	7.02	7.00	6.88	780.1	949.1	30.03	32.22	27.88	780.1	949.1	0.02	0.07	0.19
810.1	979.1	6.85	6.84	6.81	810.1	979.1	30.49	32.11	30.40	810.1	979.1	0.12	0.14	0.19
850.1	1019.1	6.50	6.42	6.30	850.1	1019.1	29.37	31.36	29.37	850.1	1019.1	0.14	0.13	0.17
880.1	1049.1	6.90	7.01	6.84	880.1	1049.1	29.97	30.52	30.24	880.1	1049.1	0.28	0.23	0.29
920.1	1089.1	7.62	7.73	7.70	920.1	1089.1	32.08	33.31	33.35	920.1	1089.1	0.16	0.11	0.08
950.1	1119.1	7.41	7.36	7.27	950.1	1119.1	30.56	32.07	32.14	950.1	1119.1	0.32	0.20	0.18
990.1	1159.1	7.44	7.35	7.29	990.1	1159.1	28.77	29.61	30.04	990.1	1159.1	0.41	0.23	0.18
1020.1	1189.1	7.31	7.22	7.16	1020.1	1189.1	27.67	28.58	29.39	1020.1	1189.1	0.45	0.23	0.20
1060.1	1229.1	7.34	7.19	7.11	1060.1	1229.1	26.04	27.47	28.67	1060.1	1229.1	0.52	0.25	0.21
1090.1	1259.1	7.28	7.03	6.91	1090.1	1259.1	25.92	27.48	28.46	1090.1	1259.1	0.57	0.30	0.26
1130.1	1299.1	7.31	6.97	6.83	1130.1	1299.1	24.64	25.93	26.58	1130.1	1299.1	0.64	0.41	0.37
1160.1	1329.1	7.53	7.12	6.95	1160.1	1329.1	23.26	24.21	24.56	1160.1	1329.1	0.85	0.51	0.47
1200.1	1369.1	7.93	7.50	7.27	1200.1	1369.1	22.72	23.72	24.05	1200.1	1369.1	1.31	0.82	0.71
1230.1	1399.1	8.22	7.80	7.62	1230.1	1399.1	22.98	23.26	23.05	1230.1	1399.1	1.50	0.98	0.76
1270.1	1439.1	8.50	8.10	8.02	1270.1	1439.1	24.00	25.17	26.78	1270.1	1439.1	1.71	1.23	1.01
1300.1	1469.1	8.62	8.28	8.25	1300.1	1469.1	23.20	24.67	26.64	1300.1	1469.1	1.80	1.38	1.20
1340.1	1509.1	8.76	8.54	8.51	1340.1	1509.1	21.43	23.68	24.92	1340.1	1509.1	2.04	1.56	1.47
1370.1	1539.1	8.68	8.53	8.40	1370.1	1539.1	20.44	22.16	22.53	1370.1	1539.1	2.14	1.67	1.85
1410.1	1579.1	8.78	8.85	8.92	1410.1	1579.1	19.62	21.13	22.52	1410.1	1579.1	2.15	1.56	1.70
1440.1	1609.1	9.12	9.49	10.01	1440.1	1609.1	19.29	21.78	23.02	1440.1	1609.1	2.17	1.45	1.28
1480.1	1649.1	9.99	10.69	11.77	1480.1	1649.1	18.98	20.69	20.89	1480.1	1649.1	2.12	1.41	1.04
1510.1	1679.1	10.64	11.28	12.89	1510.1	1679.1	20.65	21.48	21.57	1510.1	1679.1	1.80	1.16	0.26



Frequency Mixer

AMCY-ED12679/1

Typical Performance Data

IF (OUT) (MHz)	LO (MHz)	CONVERSION LOSS VS. IF FREQUENCY @RF(IN)=897.5MHz (dB)
		@LO (dBm)
		0
507.4	390.1	10.31
481.2	416.3	9.39
455.0	442.5	8.94
428.9	468.6	8.91
402.7	494.8	9.38
376.5	521.0	8.59
350.3	547.2	7.74
324.2	573.4	7.36
298.0	599.5	7.09
271.8	625.7	7.14
245.6	651.9	7.39
219.4	678.1	7.20
193.3	704.3	7.97
167.1	730.4	6.82
140.9	756.6	6.76
114.7	782.8	7.03
88.5	809.0	7.32
62.4	835.1	7.86
36.2	861.3	9.00
10.0	887.5	16.30
32.2	929.7	9.25
65.4	962.9	7.69
98.6	996.1	7.08
131.9	1029.4	6.68
165.1	1062.6	7.56
198.4	1095.9	7.52
231.6	1129.1	7.22
264.8	1162.3	7.09
298.1	1195.6	7.00
331.3	1228.8	7.08
364.5	1262.0	7.34
397.8	1295.3	7.71
431.0	1328.5	8.11
464.3	1361.8	8.54
497.5	1395.0	8.98
530.7	1428.2	9.31
564.0	1461.5	9.50
597.2	1494.7	9.70
619.4	1516.9	9.87
652.6	1550.1	10.18

IF (OUT) (MHz)	LO (MHz)	CONVERSION LOSS VS. IF FREQUENCY @RF(IN)=880.1MHz (dB)
		@LO (dBm)
		0
10.0	890.1	16.40
31.6	911.7	9.33
53.3	933.4	7.77
74.9	955.0	7.52
96.6	976.7	7.25
118.2	998.3	6.83
139.8	1019.9	6.54
150.7	1030.8	6.54
172.3	1052.4	7.15
183.1	1063.2	7.43
204.8	1084.9	7.49
215.6	1095.7	7.49
237.2	1117.3	7.11
248.0	1128.1	7.17
269.7	1149.8	7.01
280.5	1160.6	7.03
302.1	1182.2	6.94
313.0	1193.1	6.93
334.6	1214.7	7.00
345.4	1225.5	7.08
367.1	1247.2	7.18
377.9	1258.0	7.31
399.5	1279.6	7.44
410.3	1290.4	7.61
432.0	1312.1	7.92
442.8	1322.9	8.08
464.4	1344.5	8.28
475.3	1355.4	8.47
496.9	1377.0	8.74
507.7	1387.8	8.87
529.3	1409.4	9.14
540.2	1420.3	9.25
561.8	1441.9	9.41
572.6	1452.7	9.47
594.3	1474.4	9.54
605.1	1485.2	9.65
626.7	1506.8	9.83
637.5	1517.6	9.94
659.2	1539.3	10.20
670.0	1550.1	10.25

IF (OUT) (MHz)	LO (MHz)	CONVERSION LOSS VS. IF FREQUENCY @RF(IN)=915.1MHz (dB)
		@LO (dBm)
		0
530.1	385.0	10.79
520.1	395.0	10.29
510.1	405.0	9.85
500.1	415.0	9.54
490.1	425.0	9.30
480.1	435.0	9.16
470.1	445.0	8.98
460.1	455.0	8.99
450.1	465.0	8.91
440.1	475.0	9.11
430.1	485.0	9.18
420.1	495.0	9.50
410.1	505.0	9.60
400.1	515.0	9.23
380.1	535.0	8.29
370.1	545.0	8.06
350.1	565.0	7.68
340.1	575.0	7.52
320.1	595.0	7.33
310.1	605.0	7.22
290.1	625.0	7.26
280.1	635.0	7.31
260.1	655.0	7.46
250.1	665.0	7.45
230.1	685.0	7.26
220.1	695.0	7.35
200.1	715.0	7.44
190.1	725.0	6.99
170.1	745.0	6.83
160.1	755.0	6.86
140.1	775.0	6.98
130.1	785.0	7.01
110.1	805.0	7.26
100.1	815.0	7.32
80.1	835.0	7.62
70.1	845.0	7.74
50.1	865.0	8.08
40.1	875.0	8.63
20.1	895.0	11.52
10.1	905.0	16.32

REV. X2

AMCY-ED12679/1

101012

Page 2 of 5



IF/RF MICROWAVE COMPONENTS • ISO 9001 ISO 14001 AS 9100 CERTIFIED • RoHS compliant

P.O. Box 350166, Brooklyn, New York 11235-0003 (718) 934-4500 Fax (718) 332-4661



The Design Engineers Search Engine finds the model you need, Instantly • For detailed performance specs & shopping online see



Frequency Mixer

AMCY-ED12679/1

Typical Performance Data

LO (MHz)	LO-RF ISOLATION (dB)			LO-IF ISOLATION (dB)		
	@LO (dBm)			@LO (dBm)		
	-3	0	+3	-3	0	+3
359.1	27.25	25.59	26.97	37.95	39.93	35.96
389.1	33.69	33.26	36.05	31.15	30.24	28.39
419.1	32.12	32.84	37.46	29.15	28.45	27.72
449.1	31.41	33.48	43.30	27.28	27.04	28.70
479.1	28.25	28.64	44.05	25.03	26.31	32.94
509.1	24.50	23.48	28.43	22.57	22.62	27.16
539.1	22.39	21.99	24.90	19.77	19.71	22.84
569.1	20.32	20.32	22.78	17.71	17.98	20.73
599.1	20.23	21.54	22.68	16.62	18.40	21.69
629.1	20.16	22.36	20.41	15.11	17.42	23.38
669.1	18.36	19.64	20.28	14.23	16.60	20.50
699.1	13.48	13.90	15.16	16.11	17.99	21.78
739.1	16.91	17.20	18.86	14.14	16.03	18.49
769.1	18.64	19.00	20.76	13.67	15.20	17.58
809.1	20.63	21.37	23.48	12.44	13.51	16.04
839.1	22.06	22.98	25.54	11.51	12.55	14.96
879.1	25.69	24.13	24.40	10.52	11.50	13.83
909.1	23.13	22.48	20.85	9.30	10.28	12.66
949.1	17.10	17.50	20.45	8.21	9.14	11.16
979.1	15.92	16.33	18.95	6.29	7.03	8.88
1019.1	16.56	17.43	19.82	3.90	5.04	7.10
1049.1	16.32	18.05	17.91	2.78	4.62	6.77
1089.1	19.55	23.13	24.53	6.02	8.01	10.40
1119.1	20.92	25.56	30.81	6.76	8.32	10.48
1159.1	18.37	19.62	21.02	6.07	7.23	9.26
1189.1	20.29	22.16	23.98	8.19	9.27	11.32
1229.1	21.84	23.54	24.61	11.81	13.03	15.24
1259.1	19.96	21.99	24.01	12.41	13.42	15.63
1299.1	13.14	13.82	15.94	13.32	14.23	16.45
1329.1	11.27	11.39	13.25	13.46	14.36	16.58
1369.1	10.00	9.70	11.04	13.71	14.90	16.78
1399.1	9.79	9.47	10.38	14.25	15.89	18.40
1439.1	10.14	10.19	10.98	15.20	17.16	20.24
1469.1	10.46	10.75	11.78	16.11	18.38	21.67
1509.1	10.93	11.29	12.48	17.24	19.88	23.17
1539.1	11.20	11.50	12.65	18.03	20.97	24.08
1579.1	12.31	13.02	14.52	18.23	21.08	23.74
1609.1	13.48	14.76	16.71	17.63	20.24	23.29
1649.1	15.15	17.28	20.25	16.47	18.74	22.39
1679.1	15.32	17.57	21.06	15.98	18.20	21.95

RF (IN) (MHz)	LO (MHz)	RF-IF ISOLATION (dB)		
		@LO (dBm)		
		-3	0	+3
190.1	359.1	25.75	20.76	16.77
220.1	389.1	25.95	20.18	15.14
250.1	419.1	26.31	20.28	15.01
280.1	449.1	25.98	18.92	14.42
310.1	479.1	25.73	18.22	15.36
340.1	509.1	31.81	29.65	25.18
370.1	539.1	26.52	18.39	19.54
400.1	569.1	23.14	17.68	15.92
430.1	599.1	22.29	17.53	15.78
460.1	629.1	22.00	17.70	16.75
500.1	669.1	20.98	17.60	17.04
530.1	699.1	26.08	24.13	29.41
570.1	739.1	31.37	29.53	27.36
600.1	769.1	31.05	30.65	29.58
640.1	809.1	30.05	29.81	29.97
670.1	839.1	28.79	28.47	28.67
710.1	879.1	27.28	27.74	28.68
740.1	909.1	28.29	28.44	30.05
780.1	949.1	33.64	32.53	32.45
810.1	979.1	29.57	29.68	29.45
850.1	1019.1	26.40	27.79	30.77
880.1	1049.1	24.21	24.35	29.62
920.1	1089.1	25.41	24.07	26.67
950.1	1119.1	23.23	23.72	24.78
990.1	1159.1	22.51	23.11	23.90
1020.1	1189.1	21.97	22.38	22.90
1060.1	1229.1	22.15	22.40	22.98
1090.1	1259.1	23.01	24.11	25.15
1130.1	1299.1	21.79	22.86	23.80
1160.1	1329.1	20.20	21.15	21.79
1200.1	1369.1	18.06	18.71	19.39
1230.1	1399.1	16.92	17.18	17.62
1270.1	1439.1	16.06	16.01	16.24
1300.1	1469.1	15.76	15.58	15.65
1340.1	1509.1	15.77	15.58	15.66
1370.1	1539.1	15.98	15.89	15.87
1410.1	1579.1	16.29	16.28	16.21
1440.1	1609.1	16.47	16.27	15.89
1480.1	1649.1	16.70	16.52	16.41
1510.1	1679.1	16.97	17.30	17.56



Frequency Mixer

AMCY-ED12679/1

Typical Performance Data

RF (IN) (MHz)	LO (MHz)	RF VSWR (:1)		
		@LO (dBm)		
		-3	0	+3
190.1	359.1	2.77	2.50	2.42
220.1	389.1	2.05	1.85	1.77
250.1	419.1	1.58	1.45	1.47
280.1	449.1	1.25	1.20	1.31
310.1	479.1	1.04	1.07	1.19
340.1	509.1	1.14	1.17	1.14
370.1	539.1	1.31	1.43	1.44
400.1	569.1	1.44	1.54	1.50
430.1	599.1	1.56	1.62	1.56
460.1	629.1	1.65	1.65	1.61
500.1	669.1	1.78	1.80	1.68
530.1	699.1	1.75	1.67	1.53
570.1	739.1	1.75	1.77	1.78
600.1	769.1	1.70	1.71	1.72
640.1	809.1	1.61	1.59	1.58
670.1	839.1	1.62	1.59	1.57
710.1	879.1	1.66	1.63	1.63
740.1	909.1	1.56	1.53	1.55
780.1	949.1	1.31	1.25	1.23
810.1	979.1	1.20	1.15	1.15
850.1	1019.1	1.19	1.13	1.13
880.1	1049.1	1.09	1.04	1.03
920.1	1089.1	1.20	1.23	1.24
950.1	1119.1	1.27	1.26	1.26
990.1	1159.1	1.35	1.35	1.35
1020.1	1189.1	1.43	1.42	1.41
1060.1	1229.1	1.57	1.55	1.54
1090.1	1259.1	1.62	1.57	1.54
1130.1	1299.1	1.62	1.55	1.51
1160.1	1329.1	1.60	1.51	1.46
1200.1	1369.1	1.55	1.43	1.36
1230.1	1399.1	1.49	1.40	1.32
1270.1	1439.1	1.40	1.34	1.33
1300.1	1469.1	1.35	1.31	1.31
1340.1	1509.1	1.29	1.26	1.27
1370.1	1539.1	1.26	1.23	1.28
1410.1	1579.1	1.26	1.27	1.38
1440.1	1609.1	1.31	1.37	1.54
1480.1	1649.1	1.44	1.54	1.76
1510.1	1679.1	1.59	1.67	1.91

LO (MHz)	LO VSWR (:1)		
	@LO (dBm)		
	-3	0	+3
359.1	5.25	5.27	5.36
389.1	4.40	4.43	4.50
419.1	3.79	3.81	3.88
449.1	3.29	3.34	3.47
479.1	3.01	3.07	3.23
509.1	2.65	2.67	2.81
539.1	2.44	2.46	2.63
569.1	2.31	2.38	2.62
599.1	2.26	2.36	2.47
629.1	2.26	2.29	2.30
669.1	2.22	2.15	2.08
699.1	2.17	2.06	2.00
739.1	2.05	1.94	1.95
769.1	1.96	1.88	1.87
809.1	1.87	1.82	1.78
839.1	1.78	1.74	1.69
879.1	1.65	1.62	1.57
909.1	1.53	1.51	1.47
949.1	1.35	1.34	1.34
979.1	1.18	1.18	1.21
1019.1	1.09	1.12	1.15
1049.1	1.21	1.22	1.24
1089.1	1.43	1.41	1.39
1119.1	1.53	1.49	1.45
1159.1	1.64	1.59	1.53
1189.1	1.75	1.68	1.60
1229.1	1.76	1.72	1.60
1259.1	1.72	1.68	1.56
1299.1	1.70	1.68	1.56
1329.1	1.65	1.63	1.52
1369.1	1.60	1.57	1.47
1399.1	1.54	1.52	1.44
1439.1	1.51	1.48	1.42
1469.1	1.49	1.46	1.41
1509.1	1.49	1.47	1.42
1539.1	1.51	1.48	1.42
1579.1	1.50	1.47	1.40
1609.1	1.50	1.46	1.39
1649.1	1.49	1.45	1.35
1679.1	1.49	1.45	1.35

IF (OUT) (MHz)	IF VSWR @LO=84MHz (:1)		
	@LO (dBm)		
	-3	0	+3
10.0	12.61	12.44	12.44
30.0	4.43	4.39	4.38
50.0	2.89	2.92	2.92
70.0	2.34	2.39	2.39
90.0	2.18	2.25	2.25
110.0	1.98	2.06	2.05
130.0	1.92	2.00	2.00
150.0	1.90	1.98	1.98
170.0	1.74	1.81	1.81
190.0	1.74	1.81	1.81
210.0	1.72	1.79	1.80
230.0	1.67	1.74	1.74
250.0	1.67	1.73	1.74
270.0	1.63	1.68	1.69
290.0	1.66	1.71	1.73
310.0	1.71	1.76	1.78
330.0	1.63	1.67	1.69
350.0	1.74	1.78	1.80
370.0	1.77	1.81	1.82
390.0	1.81	1.85	1.86
410.0	1.94	1.97	1.99
440.0	2.03	2.07	2.07
460.0	2.01	2.05	2.05
490.0	2.11	2.16	2.15
510.0	2.24	2.29	2.27
540.0	2.34	2.39	2.36
560.0	2.34	2.38	2.35
590.0	2.42	2.46	2.42
610.0	2.56	2.59	2.56
640.0	2.67	2.69	2.65
660.0	2.65	2.66	2.62
690.0	2.80	2.81	2.77
710.0	3.04	3.03	3.00
740.0	3.14	3.14	3.10
760.0	3.19	3.17	3.13
790.0	3.42	3.40	3.35
810.0	3.61	3.58	3.53
840.0	3.83	3.80	3.74
860.0	3.91	3.88	3.82
890.0	4.11	4.09	4.03



Harmonics Tables

RF HARMONICS ORDER

	(-dBm)	(-dBc)										
0	-	-	+1	5	16	20	22	34	21	35	36	39
1	-	15	+0	21	19	39	52	41	42	54	48	48
2	61	71	64	54	70	56	71	81	68	73	75	78
3	>90	81	72	81	74	>83	76	>83	>83	>83	>83	>83
4	>90	>83	>83	>83	>83	>83	>83	>83	>83	>83	>83	>83
5	>90	>83	>83	>83	>83	>83	>83	>83	>83	>83	>83	>83
6	>90	>83	>83	>83	>83	>83	>83	>83	>83	>83	>83	>83
7	>90	>83	>83	>83	>83	>83	>83	>83	>83	>83	>83	>83
8	>90	>83	>83	>83	>83	>83	>83	>83	>83	>83	>83	>83
9	>90	>83	>83	>83	>83	>83	>83	>83	>83	>83	>83	>83
10	>90	>83	>83	>83	>83	>83	>83	>83	>83	>83	>83	>83
	RF CAL	0	1	2	3	4	5	6	7	8	9	10

LO HARMONICS ORDER

Test conditions: RF IN: 897.50 MHz; 0.00 dBm.
 LO IN: 1066.50 MHz; 0.00 dBm
 IF OUT: 169.00 MHz; -7.23 dBm

RF HARMONICS ORDER

	(-dBm)	(-dBc)										
0	-	-	8	15	26	31	32	45	32	45	47	51
1	-	15	+0	21	19	40	50	42	42	54	49	49
2	42	62	56	45	58	46	61	70	58	63	66	70
3	65	62	53	62	55	69	58	76	77	83	78	80
4	90	85	75	83	84	83	90	84	>93	>93	>93	>93
5	>90	>93	92	86	>93	>93	>93	>93	>93	>93	>93	>93
6	>90	>93	>93	>93	>93	>93	90	>93	>93	>93	>93	>93
7	>90	>93	>93	>93	>93	>93	>93	>93	>93	>93	>93	>93
8	>90	>93	>93	>93	>93	>93	>93	>93	>93	>93	>93	>93
9	>90	>93	>93	>93	>93	>93	>93	>93	>93	>93	>93	>93
10	>90	>93	>93	>93	>93	>93	>93	>93	>93	>93	>93	>93
	RF CAL	0	1	2	3	4	5	6	7	8	9	10

LO HARMONICS ORDER

Test conditions: RF IN: 897.50 MHz; 10.00 dBm.
 LO IN: 1066.50 MHz; 0.00 dBm
 IF OUT: 169.00 MHz; +2.71 dBm

- Notes: 1. All Harmonics are in (dBc) relative to IF OUTPUT.
 2. + entry denotes harmonics are in (dBc) above IF OUTPUT.
 3. RF Cal represent the Harmonics level of the RF input signal to the mixer.



Typical Performance Curves

Conversion Loss @ IF=169MHz

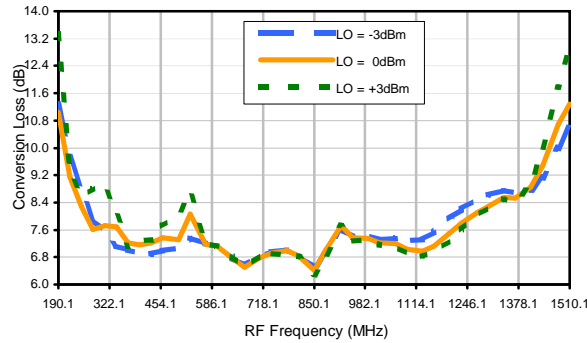

Conversion Loss vs. LO @ RF=897.5MHz

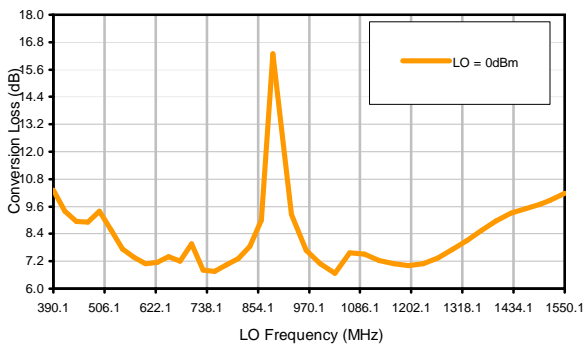

Conversion Loss vs. IF @ RF=897.5MHz

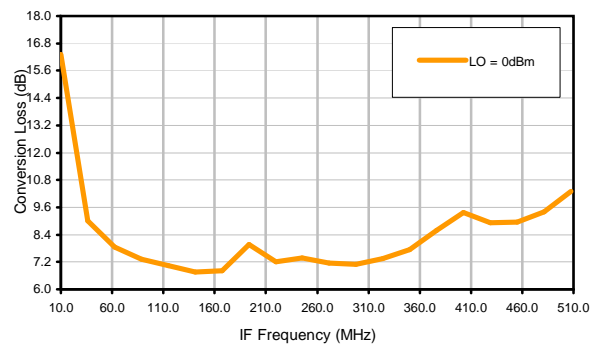

Conversion Loss vs. IF @ RF=880.1MHz

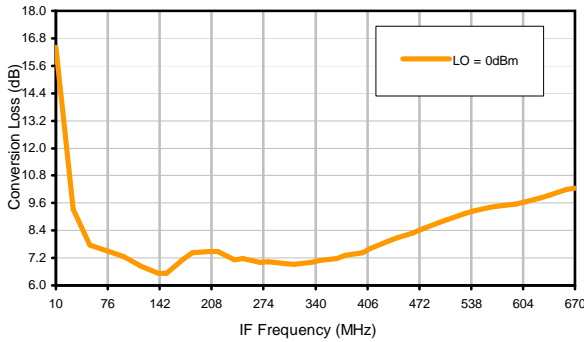

Conversion Loss vs. IF @ RF=915.1MHz

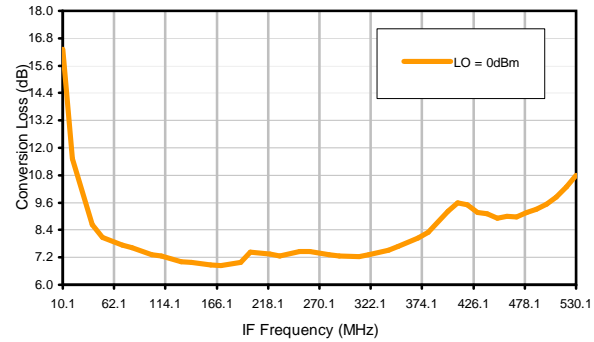

IP3 Input

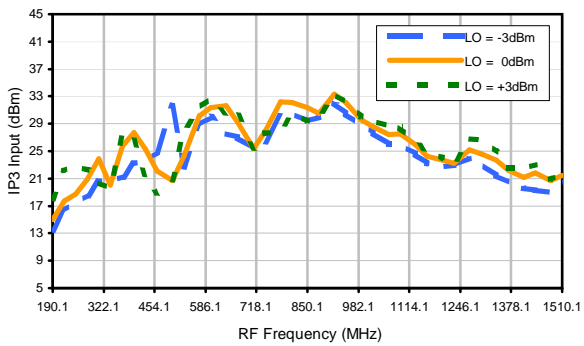

Compression @ RF IN=+15dBm

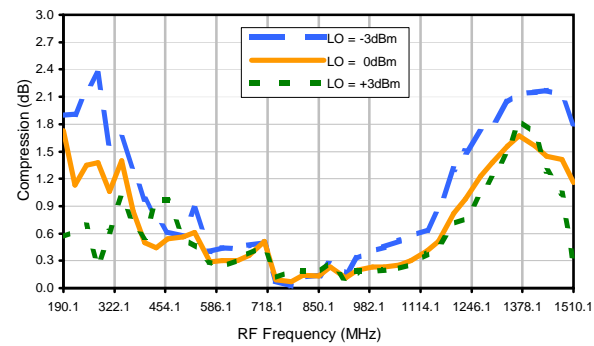

Frequency Mixer

AMCY-ED12679/1

Typical Performance Curves

LO-RF Isolation

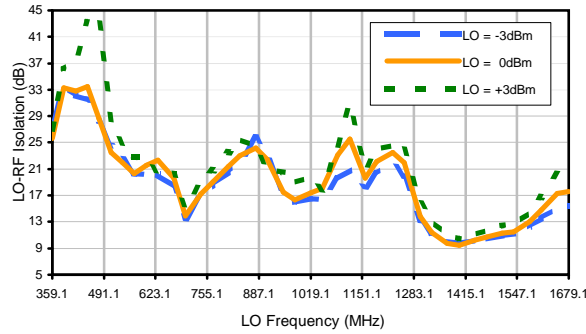

LO-IF Isolation

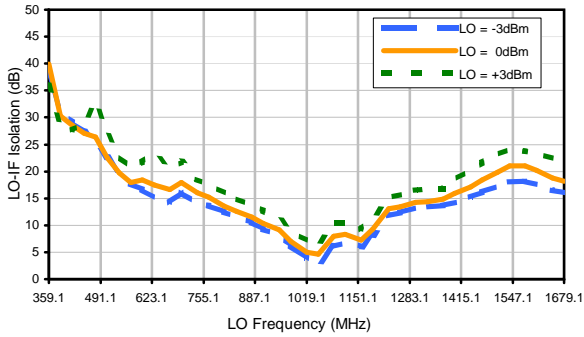

RF-IF Isolation

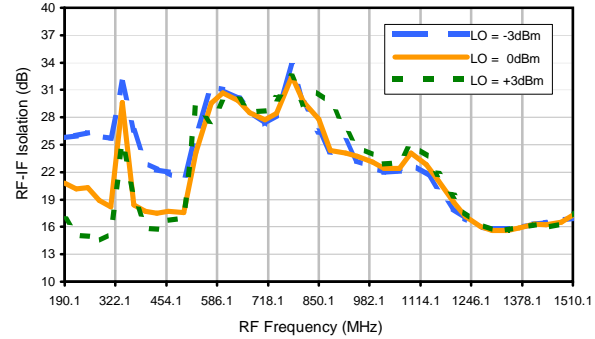

RF VSWR

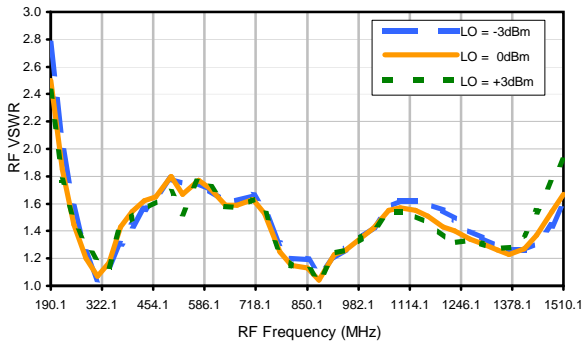

LO VSWR

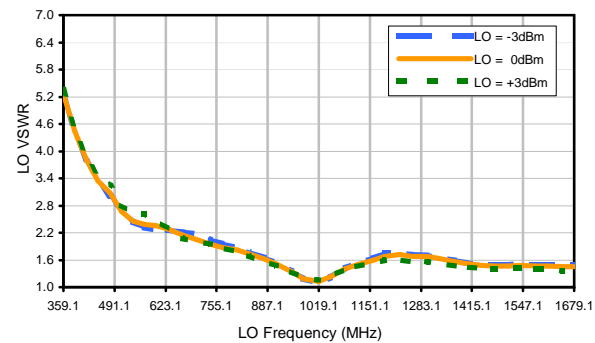

IF VSWR

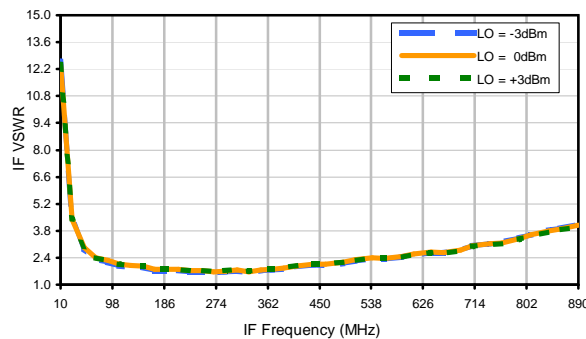

REV. X2
AMCY-ED12679/1
101012
Page 2 of 3



IF/RF MICROWAVE COMPONENTS • ISO 9001 ISO 14001 AS 9100 CERTIFIED RoHS compliant
P.O. Box 350166, Brooklyn, New York 11235-0006 (718) 934-4500 Fax (718) 332-4661



The Design Engineers Search Engine finds the model you need, Instantly • For detailed performance specs & shopping online see



Harmonics Tables

RF HARMONICS ORDER

	(-dBm)	(-dBc)										
0	-	-	+1	5	16	20	22	34	21	35	36	39
1	-	15	+0	21	19	39	52	41	42	54	48	48
2	61	71	64	54	70	56	71	81	68	73	75	78
3	>90	81	72	81	74	>83	76	>83	>83	>83	>83	>83
4	>90	>83	>83	>83	>83	>83	>83	>83	>83	>83	>83	>83
5	>90	>83	>83	>83	>83	>83	>83	>83	>83	>83	>83	>83
6	>90	>83	>83	>83	>83	>83	>83	>83	>83	>83	>83	>83
7	>90	>83	>83	>83	>83	>83	>83	>83	>83	>83	>83	>83
8	>90	>83	>83	>83	>83	>83	>83	>83	>83	>83	>83	>83
9	>90	>83	>83	>83	>83	>83	>83	>83	>83	>83	>83	>83
10	>90	>83	>83	>83	>83	>83	>83	>83	>83	>83	>83	>83
	RF CAL	0	1	2	3	4	5	6	7	8	9	10

LO HARMONICS ORDER

Test conditions: RF IN: 897.50 MHz; 0.00 dBm.
 LO IN: 1066.50 MHz; 0.00 dBm
 IF OUT: 169.00 MHz; -7.23 dBm

RF HARMONICS ORDER

	(-dBm)	(-dBc)										
0	-	-	8	15	26	31	32	45	32	45	47	51
1	-	15	+0	21	19	40	50	42	42	54	49	49
2	42	62	56	45	58	46	61	70	58	63	66	70
3	65	62	53	62	55	69	58	76	77	83	78	80
4	90	85	75	83	84	83	90	84	>93	>93	>93	>93
5	>90	>93	92	86	>93	>93	>93	>93	>93	>93	>93	>93
6	>90	>93	>93	>93	>93	>93	90	>93	>93	>93	>93	>93
7	>90	>93	>93	>93	>93	>93	>93	>93	>93	>93	>93	>93
8	>90	>93	>93	>93	>93	>93	>93	>93	>93	>93	>93	>93
9	>90	>93	>93	>93	>93	>93	>93	>93	>93	>93	>93	>93
10	>90	>93	>93	>93	>93	>93	>93	>93	>93	>93	>93	>93
	RF CAL	0	1	2	3	4	5	6	7	8	9	10

LO HARMONICS ORDER

Test conditions: RF IN: 897.50 MHz; 10.00 dBm.
 LO IN: 1066.50 MHz; 0.00 dBm
 IF OUT: 169.00 MHz; +2.71 dBm

- Notes: 1. All Harmonics are in (dBc) relative to IF OUTPUT.
 2. + entry denotes harmonics are in (dBc) above IF OUTPUT.
 3. RF Cal represent the Harmonics level of the RF input signal to the mixer.



Outline Dimensions

BJ293
BJ398

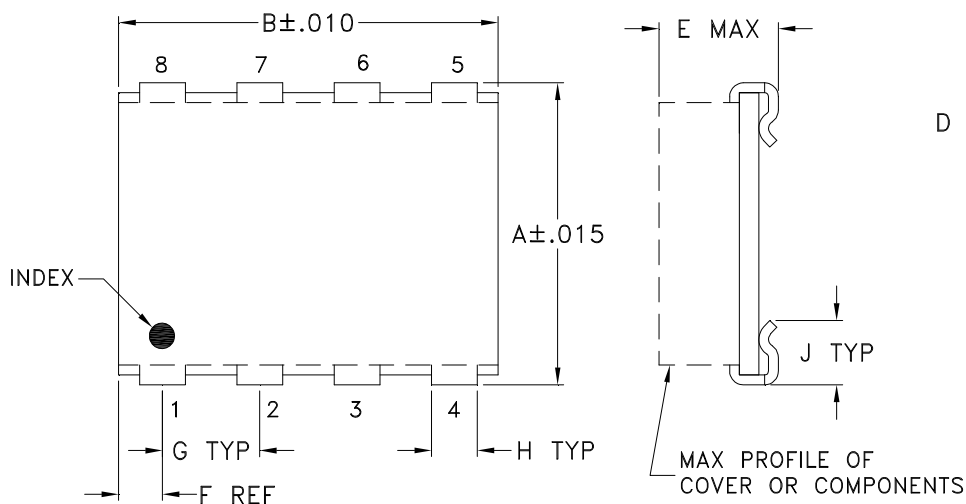

PCB Land Pattern

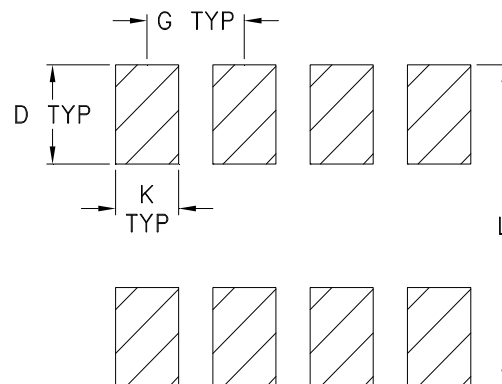

Suggested Layout,
Tolerance to be within $\pm .002$

CASE#	A	B	C	D	E	F	G	H	J	K	L	WT. GRAMS
BJ293	.395 (10.03)	.500 (12.70)	-- --	.100 (2.54)	.230 (5.84)	.100 (2.54)	.100 (2.54)	.047 (1.19)	.065 (1.65)	.065 (1.65)	.425 (10.80)	.80
BJ398	.305 (7.75)	.390 (9.91)	-- --	.100 (2.54)	.105 (2.67)	.045 (1.14)	.100 (2.54)	.047 (1.19)	.065 (1.65)	.065 (1.65)	.325 (8.26)	.20

Dimensions are in inches (mm). Tolerances: 2Pl. $\pm .01$; 3Pl. $\pm .005$

Notes:

- Case material: Plastic.
- Base material: Printed wiring laminate.
- Termination finish:
 - For RoHS Case Styles: Tin plate over Nickel plate. All models, (+) suffix.
 - For RoHS-5 Case Styles: Tin-Lead plate. All models, no (+) suffix.



INTERNET <http://www.minicircuits.com>

P.O. Box 350166, Brooklyn, New York 11235-0003 (718) 934-4500 Fax (718) 332-4661

Distribution Centers NORTH AMERICA 800-654-7949 • 417-335-5935 • Fax 417-335-5945 • EUROPE 44-1252-832600 • Fax 44-1252-837010

Mini-Circuits ISO 9001 & ISO 14001 Certified

Tape & Reel Packaging TR-F10

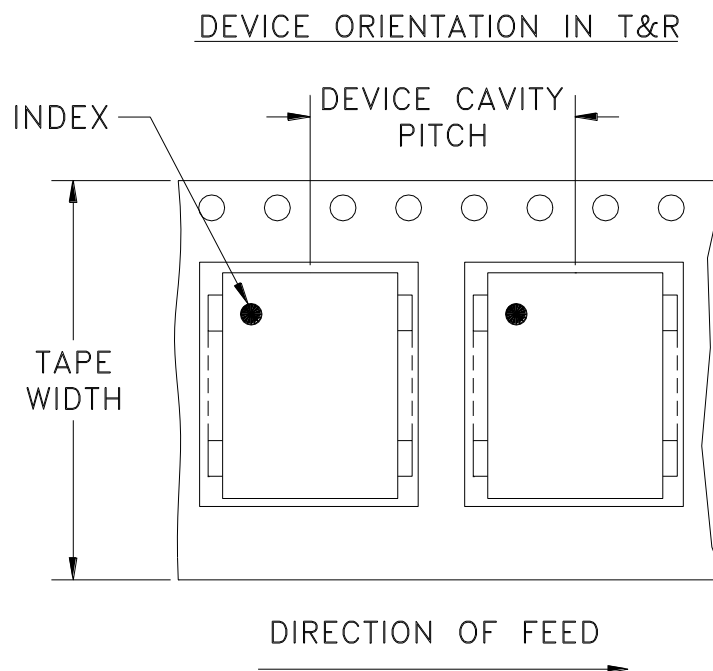

Tape Width, mm	Device Cavity Pitch, mm	Reel Size, inches	Devices per Reel
24	16	7	10,20,50,100
		13	200,500

Mini-Circuits carrier tape materials provide protection from ESD (Electro-Static Discharge) during handling and transportation. Tapes are static dissipative and comply with industry standards EIA-481/EIA-541.

Go to: www.minicircuits.com/pages/pdfs/tape.pdf

Note: Please consult individual model data sheet to determine device per reel availability.



INTERNET <http://www.minicircuits.com>

P.O. Box 350166, Brooklyn, New York 11235-0003 (718) 934-4500 Fax (718) 332-4661

Distribution Centers NORTH AMERICA 800-654-7949 • 417-335-5935 • Fax 417-335-5945 • EUROPE 44-1252-832600 • Fax 44-1252-837010

Mini-Circuits ISO 9001 & ISO 14001 Certified

THIRD ANGLE PROJECTION

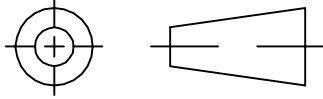

REVISIONS

REV	ECN No.	DESCRIPTION	DATE	DR	AUTH
OR	M109132	NEW RELEASE	01/29/07	AV	DJ

**SUGGESTED MOUNTING CONFIGURATION
FOR BJ937-1 CASE STYLE, "nv" PIN CONNECTION.**

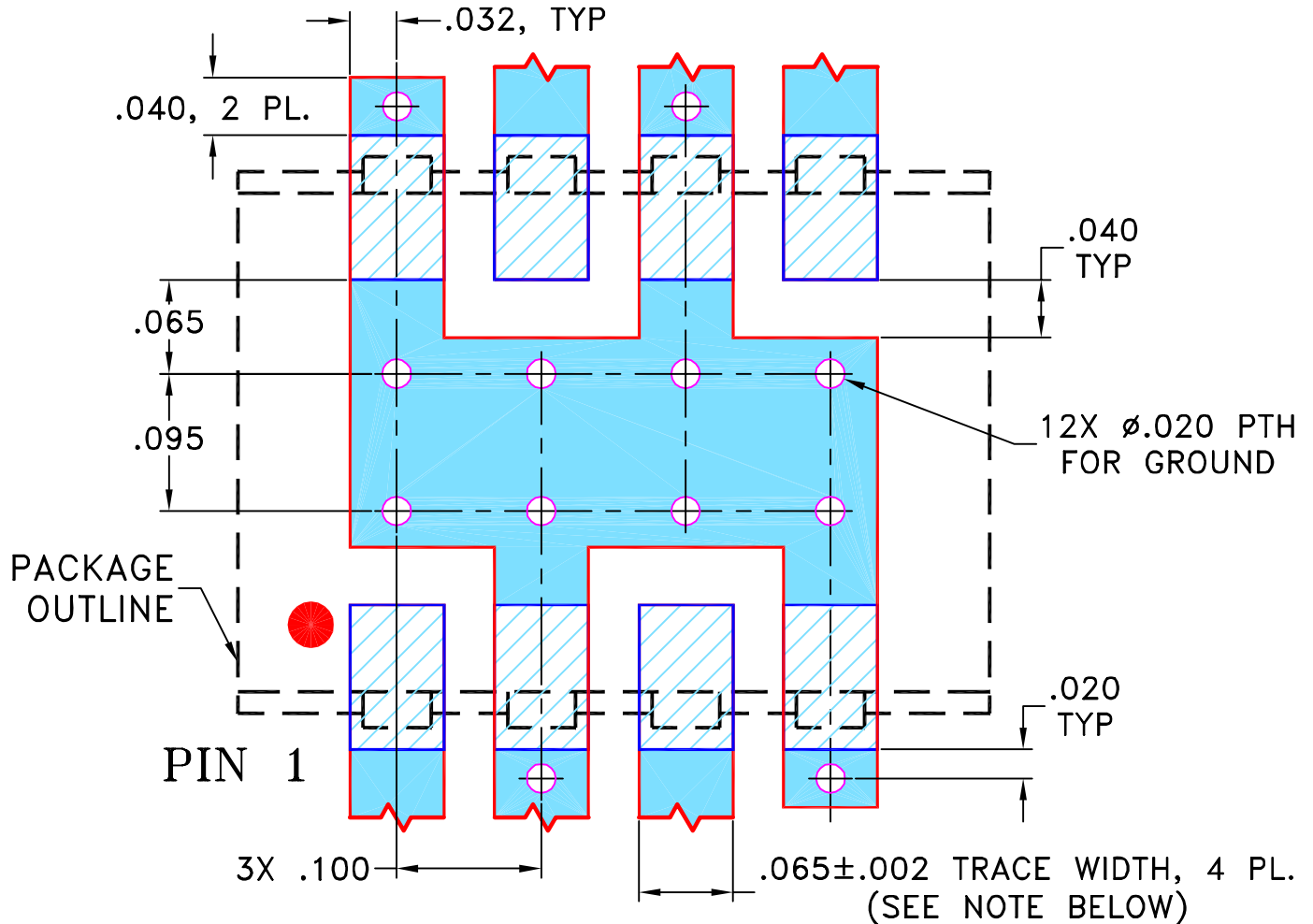

- NOTE: 1. TRACE WIDTH IS SHOWN FOR ROGERS R04350B WITH DIELECTRIC THICKNESS 0.030" ± 0.002"; COPPER: 1/2 OZ. EACH SIDE. FOR OTHER MATERIALS TRACE WIDTH MAY NEED TO BE MODIFIED.
2. BOTTOM SIDE OF THE PCB IS CONTINUOUS GROUND PLANE.

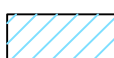
 DENOTES PCB COPPER LAYOUT WITH SMOBC (SOLDER MASK OVER BARE COPPER)
 DENOTES COPPER LAND PATTERN FREE OF SOLDER MASK

UNLESS OTHERWISE SPECIFIED	INITIALS	DATE
DIMENSIONS ARE IN INCHES	DRAWN AV	01/03/07
TOLERANCES ON:	CHECKED IL	01/29/07
2 PL DECIMALS ±	APPROVED DJ	01/29/07
3 PL DECIMALS ± .005		
ANGLES ±		
FRACTIONS ±		

 **Mini-Circuits®** 13 Neptune Avenue
Brooklyn NY 11235

PL, nv, BJ937-1, MAX, TB-434+

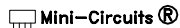
 Mini-Circuits®
THIS DOCUMENT AND ITS CONTENTS ARE THE PROPERTY OF MINI-CIRCUITS. EXCEPT FOR USE EXPRESSLY GRANTED, IN WRITING, TO ITS VENDORS, VENDEE AND THE UNITED STATES GOVERNMENT, MINI-CIRCUITS RESERVES ALL PROPRIETARY DESIGN, USE, MANUFACTURING AND REPRODUCTION RIGHTS THERETO. THESE CONTENTS SHALL NOT BE USED, DUPLICATED OR DISCLOSED TO ANY OUTSIDE PARTY, IN WHOLE OR IN PART, WITHOUT WRITTEN PERMISSION OF MINI-CIRCUITS.

SIZE	CODE IDENT	DRAWING NO:	REV:
A	15542	98-PL-263	OR
FILE:	98PL263	SCALE: 8:1	SHEET: 1 OF 1

Evaluation Board and Circuit

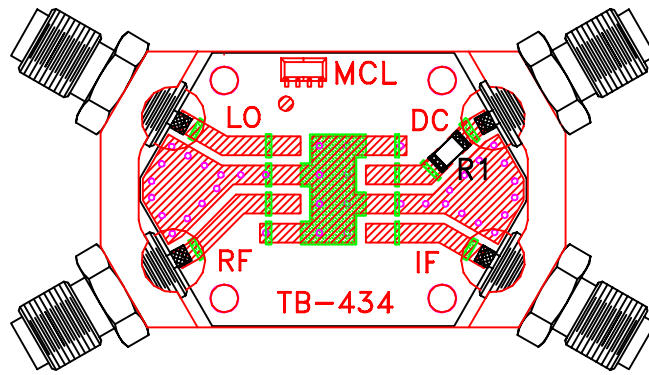

TB-434+

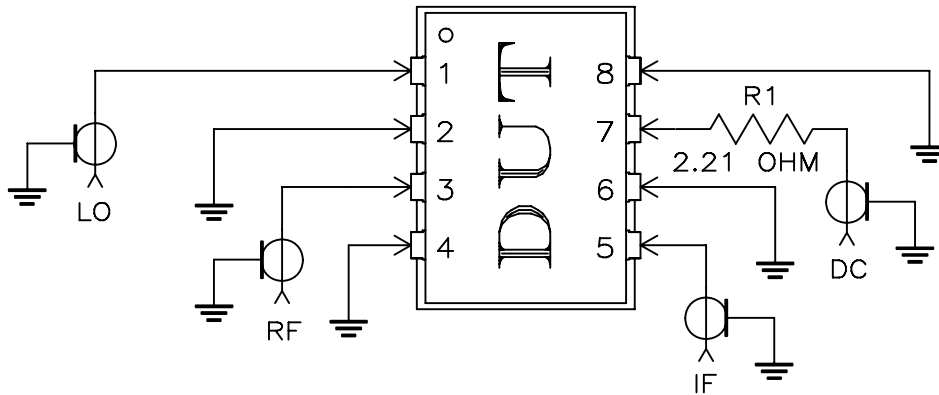

Schematic Diagram

Notes:

1. 50 Ohm SMA Female connectors.
2. PCB Material: Rogers R04350 or equivalent,
Dielectric Constant=3.5, Thickness=.030 inch.

 Mini-Circuits®

All Mini-Circuits products are manufactured under exacting quality assurance and control standards, and are capable of meeting published specifications after being subjected to any or all of the following physical and environmental test.

Specification	Test/Inspection Condition	Reference/Spec
Operating Temperature	-40° to 85°C Ambient Environment	Individual Model Data Sheet
Storage Temperature	-55° to 100° C Ambient Environment	Individual Model Data Sheet
Thermal Shock	-55° to 100°C, 100 cycles	MIL-STD-202, Method 107, Condition A-3, except +100°C
Vibration (High Frequency)	20g peak, 10-2000 Hz, 12 times in each of three perpendicular directions (total 36)	MIL-STD-202, Method 204, Condition D
Mechanical Shock	50g, 11 ms, 1/2-sine, 18 shocks: 3 each direction, each of 3 axes	MIL-STD-202, Method 213, Condition A
Humidity	90 to 95% RH, 240 hours, 50°C	MIL-STD-202, Method 103, Condition A, Except 50°C and end-point electrical test done within 12 hours
Solderability	10X Magnification	J-STD-002, Para 4.2.5, Test S, 95% Coverage
Solder Reflow Heat	Sn-Pb Eutectic Process: 225°C peak Pb-Free Process: 250°C peak	J-STD-020, Table 4-1, 4-2 and 5-2; Figure 5-1
Marking Resistance to Solvents	Isopropyl alcohol + mineral spirits at 25°C; terpene defluxer at 25°C; distilled water + proylene glycol monomethyl ether + monoethanolamine at 63°C to 70°C	MIL-STD-202, Method 215