

High Power Bi-Directional Coupler

BDCA-15-25+

50Ω 15dB Coupling DC Pass 800 to 2500 MHz



Generic photo used for illustration purposes only

CASE STYLE: DZ944

+RoHS Compliant

The +Suffix identifies RoHS Compliance. See our web site for RoHS Compliance methodologies and qualifications



Available Tape and Reel at no extra cost

Reel Size	Devices/Reel
7"	20, 50, 100, 200
13"	500, 1000

Maximum Ratings

Operating Temperature	-55°C to 100°C
Storage Temperature	-55°C to 100°C
DC Current	0.25A

Permanent damage may occur if any of these limits are exceeded.

Pin Connections

INPUT	1
OUTPUT	6
COUPLED (forward)	10
COUPLED (reverse)	5
GROUND	2,3,4,7,8,9

Outline Drawing

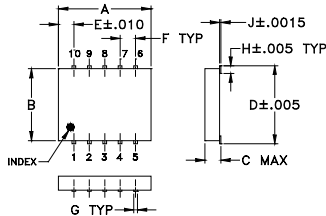

PCB Land Pattern

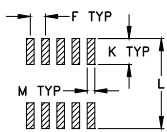

Suggested Layout
Tolerance to be within ±.002

Outline Dimensions (inch/mm)

A	B	C	D	E	F	G	
.30	.250	.052	.266	.050	.050	.012	
7.62	6.35	1.32	6.76	1.27	1.27	0.30	
H	J	K	L	M			wt
.029	.004	.085	.296	.030			grams
0.74	0.10	2.16	7.52	0.76			0.25

Demo Board MCL P/N: TB-115+ Suggested PCB Layout (PL-004)

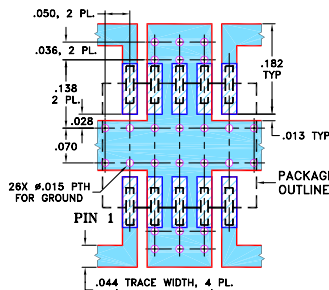

- NOTE: 1. TRACE WIDTH IS SHOWN FOR ROGERS RO4350B WITH DIELECTRIC THICKNESS .020 ± .0015; COPPER: 1/2 OZ. EACH SIDE. FOR OTHER MATERIALS TRACE WIDTH MAY NEED TO BE MODIFIED.
2. BOTTOM SIDE OF THE PCB IS CONTINUOUS GROUND PLANE.
- DENOTES PCB COPPER LAYOUT WITH SMOBC (SOLDER MASK OVER BARE COPPER)
 - DENOTES COPPER LAND PATTERN FREE OF SOLDER MASK

Notes

- A. Performance and quality attributes and conditions not expressly stated in this specification document are intended to be excluded and do not form a part of this specification document.
B. Electrical specifications and performance data contained in this specification document are based on Mini-Circuit's applicable established test performance criteria and measurement instructions.
C. The parts covered by this specification document are subject to Mini-Circuit's standard limited warranty and terms and conditions (collectively, "Standard Terms"); Purchasers of this part are entitled to the rights and benefits contained therein. For a full statement of the Standard Terms and the exclusive rights and remedies thereunder, please visit Mini-Circuit's website at www.minicircuits.com/MCLStore/terms.jsp

Features

- four-port coupler
- wideband, 800 to 2500 MHz
- excellent VSWR, 1.15:1 typ. all ports
- hermetically sealed
- minimal variation with temperature variation
- low profile. 0.07" height
- protected by US Patent 7,049,905
- DC current through input to output 0.25A Max. at 1.0 watt RF input power.

Applications

- cellular, PCA, PCN, UMTS
- ISM
- GPS

Bi-Directional Coupler Electrical Specifications

FREQUENCY (MHz)	COUPLING (dB)		MAINLINE LOSS ¹ (dB)		DIRECTIVITY (dB)		VSWR (:1)	POWER INPUT ² (W)	
	Nom.	Max. Flatness	Typ.	Max.	Typ.	Min.		Typ.	Max.
f_c - f_u									
800-2500	15±1.7	±2.4	0.5	1.0	27	11	1.20	23	
800-1000	16.3±0.8	±1.1	0.35	0.6	27	19	1.15	40	
1800-2000	13.5±0.5	±0.3	0.55	1.0	17	12	1.35	28	

1. Includes theoretical power loss of 0.14 dB at 15 dB coupling.
2. Derate linearly to 1/3 of maximum power at 100°C.

Typical Performance Data

Frequency (MHz)	Mainline Loss (dB)	Coupling (dB)		Directivity (dB)		Return Loss (dB)			
		In-Out	In-Cpl Fwd	Out-Cpl Rev	Out-Cpl Fwd	In-Cpl Rev	In	Out	Cpl Fwd
500.00	0.21	20.94	20.95	30.58	30.43	38.69	39.65	33.87	33.96
800.00	0.30	17.39	17.40	32.85	33.01	39.71	39.54	32.40	32.05
1500.00	0.52	13.88	13.89	22.68	23.09	24.28	24.41	23.32	23.40
2000.00	0.66	13.41	13.41	17.34	17.64	18.41	18.39	19.21	19.31
2100.00	0.67	13.44	13.44	16.61	16.88	17.81	17.79	18.86	18.91
2300.00	0.70	13.62	13.62	15.38	15.63	17.28	17.26	18.91	18.94
2500.00	0.71	13.93	13.90	14.40	14.62	17.56	17.45	20.15	20.17
2800.00	0.67	14.74	14.72	13.25	13.36	20.11	20.08	25.86	26.41
3000.00	0.64	15.54	15.50	12.97	13.28	23.92	24.20	35.85	47.23
3500.00	0.61	19.52	19.41	11.47	11.90	26.53	27.12	18.37	18.50

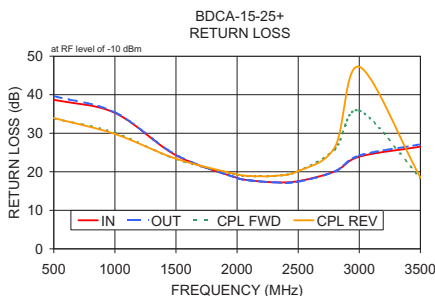
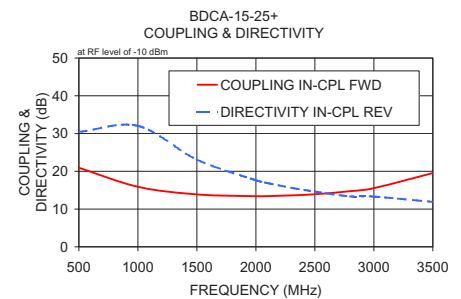
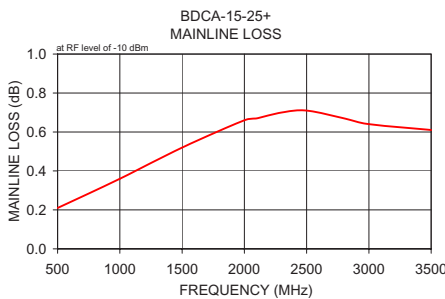

Electrical Schematic

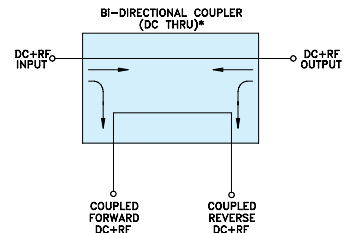

* ELECTRICAL SCHEMATIC IS FOR BI-DIRECTIONAL COUPLER WITHOUT INTERNAL TRANSFORMERS AND RESISTORS.



Bi-Directional Coupler

BDCA-15-25+

Typical Performance Data

TEST CONDITIONS: INPUT POWER =0 dBm @Temperature = +25°C

FREQ. (MHz)	INSERTION LOSS (dB)		COUPLING (dB)		DIRECTIVITY (dB)		RETURN LOSS (dB)			
	IN-OUT	FWD-REV	IN-FWD	OUT-REV	IN-REV	OUT-FWD	IN	OUT	FWD	REV
500	0.21	0.21	20.94	20.95	30.43	30.58	38.69	39.65	33.87	33.96
600	0.24	0.24	19.51	19.52	31.28	31.49	39.85	39.94	33.39	32.98
700	0.27	0.27	18.35	18.36	32.09	32.05	39.61	40.63	32.80	32.75
790	0.30	0.30	17.48	17.49	32.75	32.63	39.82	39.71	32.59	32.18
800	0.30	0.31	17.39	17.40	33.01	32.85	39.71	39.54	32.40	32.05
900	0.33	0.34	16.59	16.59	32.90	32.77	37.86	37.99	31.36	31.13
1000	0.36	0.37	15.90	15.91	32.03	31.65	35.28	35.42	30.10	29.81
1100	0.39	0.40	15.34	15.34	30.42	29.81	32.96	33.10	28.64	28.58
1200	0.42	0.43	14.86	14.86	28.55	27.77	30.30	30.55	27.38	27.39
1250	0.44	0.45	14.65	14.65	27.71	26.95	29.32	29.51	26.80	26.91
1300	0.45	0.47	14.46	14.46	26.51	25.94	28.21	28.33	25.87	25.97
1350	0.47	0.48	14.29	14.30	25.53	25.02	27.20	27.31	25.23	25.24
1400	0.48	0.49	14.14	14.15	24.79	24.10	26.11	26.25	24.67	24.67
1500	0.52	0.53	13.88	13.89	23.09	22.68	24.28	24.41	23.32	23.40
1600	0.55	0.56	13.69	13.69	21.80	21.39	22.70	22.75	22.33	22.30
1700	0.58	0.58	13.55	13.55	20.35	20.10	21.29	21.29	21.13	21.14
1800	0.60	0.61	13.46	13.46	19.38	19.03	20.13	20.12	20.31	20.30
1850	0.61	0.62	13.43	13.44	18.84	18.57	19.60	19.58	19.86	19.95
1900	0.63	0.63	13.42	13.42	18.41	18.10	19.11	19.14	19.56	19.59
1950	0.64	0.64	13.41	13.41	18.04	17.70	18.76	18.74	19.42	19.43
2000	0.66	0.65	13.41	13.41	17.64	17.34	18.41	18.39	19.21	19.31
2050	0.67	0.66	13.43	13.43	17.23	16.93	18.08	18.07	18.91	19.06
2100	0.67	0.67	13.44	13.44	16.88	16.61	17.81	17.79	18.86	18.91
2150	0.69	0.68	13.48	13.48	16.61	16.22	17.60	17.61	18.85	18.86
2200	0.69	0.68	13.52	13.52	16.26	15.96	17.48	17.45	18.74	18.81
2250	0.70	0.68	13.57	13.56	15.89	15.64	17.37	17.31	18.72	18.81
2300	0.70	0.69	13.62	13.62	15.63	15.38	17.28	17.26	18.91	18.94
2350	0.70	0.68	13.68	13.68	15.36	15.14	17.27	17.24	19.20	19.22
2400	0.71	0.68	13.75	13.74	15.13	14.95	17.30	17.25	19.37	19.49
2450	0.70	0.68	13.82	13.83	14.86	14.74	17.43	17.34	19.72	19.75
2500	0.71	0.68	13.93	13.90	14.62	14.40	17.56	17.45	20.15	20.17
2550	0.71	0.68	14.06	14.03	14.21	14.03	17.77	17.75	20.74	20.78
2600	0.69	0.67	14.16	14.15	14.02	13.94	18.15	18.01	21.23	21.40
2700	0.69	0.67	14.39	14.39	13.79	13.59	18.92	18.80	23.27	23.31
2800	0.67	0.66	14.74	14.72	13.36	13.25	20.11	20.08	25.86	26.41
2900	0.66	0.65	15.13	15.09	13.13	13.07	21.81	21.79	31.08	32.60
3000	0.64	0.64	15.54	15.50	13.28	12.97	23.92	24.20	35.85	47.23
3250	0.61	0.66	17.10	17.02	12.89	12.53	32.00	40.45	23.74	24.11
3500	0.61	0.71	19.52	19.41	11.90	11.47	26.53	27.12	18.37	18.50
3750	0.65	0.76	23.06	22.99	10.00	9.33	23.38	23.04	16.78	16.74
4000	0.66	0.76	29.65	29.48	3.18	2.63	24.28	23.80	17.22	17.30
4250	0.64	0.71	46.04	43.97	13.03	14.86	31.93	29.96	19.92	20.02
4500	0.67	0.71	28.06	28.02	0.85	1.05	31.70	29.48	28.16	28.57
4750	0.76	0.77	22.82	22.72	4.60	4.49	22.06	21.81	29.01	29.10
5000	0.84	0.84	20.17	20.32	6.50	6.33	18.59	18.52	21.00	20.51
5250	0.91	0.96	18.65	18.81	7.80	7.81	17.49	17.44	17.20	17.16
5500	0.94	1.03	17.76	17.98	8.48	8.61	17.90	17.80	15.81	15.63
5750	0.95	1.09	17.16	17.37	9.59	9.55	19.75	19.71	15.35	15.23
6000	0.96	1.12	16.82	16.97	10.78	10.71	23.69	24.04	15.63	15.52
6500	1.02	1.11	16.75	16.91	12.96	12.29	28.05	30.41	17.85	17.28
7000	1.15	1.16	16.85	16.77	16.13	14.11	18.52	18.97	22.17	21.88
7500	1.37	1.31	16.46	16.38	14.54	15.78	14.83	14.39	24.96	30.62
8000	1.73	1.98	15.08	15.03	5.97	7.46	12.36	11.85	12.23	13.04

REV. X1

BDCA-15-25+

081007

Page 1 of 3



IF/RF MICROWAVE COMPONENTS • ISO 9001 ISO 14001 AS 9100 CERTIFIED • RoHS compliant

P.O. Box 350166, Brooklyn, New York 11235-0003 (718) 934-4500 Fax (718) 332-4661



The Design Engineers Search Engine finds the model you need, Instantly • For detailed performance specs & shopping online see



Bi-Directional Coupler

BDCA-15-25+

Typical Performance Data

TEST CONDITIONS: INPUT POWER =0 dBm @Temperature = -55°C

FREQ. (MHz)	INSERTION LOSS		COUPLING		DIRECTIVITY		RETURN LOSS			
	(dB)		(dB)		(dB)		(dB)			
	IN-OUT	FWD-REV	IN-FWD	OUT-REV	IN-REV	OUT-FWD	IN	OUT	FWD	REV
500	0.14	0.14	20.94	20.90	29.65	29.63	36.00	36.34	31.06	31.18
600	0.16	0.17	19.50	19.46	30.12	29.89	36.40	36.38	30.39	30.31
700	0.18	0.19	18.33	18.29	30.52	30.27	35.90	35.66	30.26	30.15
790	0.21	0.21	17.46	17.41	30.76	30.56	35.73	34.99	30.55	30.33
800	0.21	0.21	17.37	17.31	30.79	30.73	35.54	34.82	30.51	30.32
900	0.23	0.24	16.55	16.50	30.73	30.70	34.39	34.66	29.43	29.21
1000	0.25	0.26	15.86	15.80	30.16	30.36	32.59	32.80	29.20	29.01
1100	0.28	0.29	15.28	15.22	29.26	29.02	31.39	31.73	27.76	27.62
1200	0.30	0.31	14.79	14.73	28.30	27.55	29.53	29.83	27.13	27.11
1250	0.32	0.32	14.58	14.51	27.81	26.67	29.11	29.35	26.33	26.35
1300	0.32	0.33	14.39	14.31	26.84	26.21	28.42	28.63	25.72	25.75
1350	0.34	0.35	14.21	14.14	26.00	25.56	27.78	27.92	25.26	25.22
1400	0.34	0.36	14.06	13.98	25.32	24.18	26.66	26.74	24.42	24.30
1500	0.37	0.38	13.79	13.71	23.65	22.68	24.22	24.43	23.55	23.51
1600	0.40	0.41	13.59	13.51	21.95	21.32	22.68	22.63	22.28	22.12
1700	0.42	0.42	13.44	13.35	20.45	20.44	21.48	21.40	21.39	21.33
1800	0.44	0.44	13.33	13.24	19.82	19.46	20.39	20.31	21.10	21.02
1850	0.45	0.45	13.30	13.21	19.38	19.22	19.93	19.84	20.80	20.90
1900	0.46	0.47	13.29	13.19	18.86	18.26	19.36	19.35	19.82	19.71
1950	0.47	0.48	13.28	13.18	18.43	17.55	19.08	18.99	19.25	19.11
2000	0.48	0.48	13.28	13.17	17.95	17.47	18.79	18.59	19.24	19.31
2050	0.49	0.49	13.29	13.19	17.39	17.00	18.23	18.05	18.83	18.91
2100	0.50	0.49	13.31	13.20	16.95	16.37	17.69	17.57	18.65	18.58
2150	0.51	0.49	13.32	13.22	16.72	16.01	17.46	17.36	18.93	18.86
2200	0.51	0.49	13.36	13.25	16.49	16.12	17.52	17.34	19.27	19.36
2250	0.51	0.49	13.41	13.29	16.13	15.94	17.46	17.28	19.00	19.02
2300	0.51	0.50	13.47	13.35	15.88	15.23	17.34	17.22	18.41	18.22
2350	0.51	0.49	13.52	13.40	15.56	14.82	17.25	17.10	18.73	18.58
2400	0.52	0.49	13.58	13.46	15.25	14.79	17.17	16.96	19.06	19.11
2450	0.51	0.49	13.65	13.53	14.84	14.24	17.20	16.98	18.97	18.82
2500	0.51	0.48	13.74	13.60	14.58	13.87	17.41	17.16	19.85	19.72
2550	0.51	0.47	13.83	13.70	14.21	13.97	17.91	17.69	21.19	21.26
2600	0.48	0.46	13.94	13.81	14.07	14.14	18.68	18.29	21.48	21.62
2700	0.48	0.46	14.18	14.05	13.82	13.76	18.96	18.69	22.90	22.75
2800	0.45	0.44	14.49	14.35	13.49	13.19	20.19	19.93	26.51	26.70
2900	0.44	0.42	14.88	14.71	13.34	13.25	21.63	21.56	30.36	31.17
3000	0.42	0.41	15.27	15.10	13.53	12.97	23.23	23.23	39.28	41.97
3250	0.38	0.42	16.76	16.57	12.83	12.52	32.90	42.25	23.63	23.80
3500	0.37	0.45	19.08	18.84	12.42	12.09	27.26	27.78	17.91	18.02
3750	0.38	0.47	22.45	22.30	10.57	9.94	24.30	24.00	16.75	16.49
4000	0.37	0.44	28.37	28.12	4.21	3.65	23.66	23.27	17.96	17.87
4250	0.35	0.40	48.05	46.67	15.76	17.00	28.11	26.74	19.66	19.72
4500	0.36	0.38	28.97	28.49	0.39	0.29	33.02	29.60	26.70	27.19
4750	0.43	0.42	23.10	22.72	4.61	4.20	23.30	23.04	31.19	36.80
5000	0.49	0.48	20.21	20.12	6.51	5.96	19.02	18.69	22.73	21.37
5250	0.55	0.57	18.48	18.47	7.89	7.39	17.47	17.19	18.08	17.31
5500	0.57	0.65	17.50	17.54	8.71	7.84	18.04	17.64	15.60	14.85
5750	0.60	0.71	16.88	16.98	9.39	8.82	18.46	18.11	14.30	13.92
6000	0.59	0.74	16.59	16.53	10.56	10.19	21.71	21.90	14.33	14.13
6500	0.59	0.67	16.48	16.37	12.10	12.82	29.73	34.32	17.77	17.51
7000	0.69	0.67	16.49	16.18	16.61	12.79	18.45	18.82	23.47	22.51
7500	0.87	0.80	16.18	15.89	15.43	16.76	15.52	14.63	21.90	26.44
8000	1.21	1.25	14.77	14.43	7.07	8.49	12.26	11.81	14.20	14.90

REV. X1

BDCA-15-25+

081007

Page 2 of 3



IF/RF MICROWAVE COMPONENTS • ISO 9001 ISO 14001 AS 9100 CERTIFIED RoHS compliant

P.O. Box 350166, Brooklyn, New York 11235-0003 (718) 934-4500 Fax (718) 332-4661



The Design Engineers Search Engine finds the model you need, Instantly • For detailed performance specs & shopping online see



Bi-Directional Coupler

BDCA-15-25+

Typical Performance Data

TEST CONDITIONS: INPUT POWER =0 dBm @Temperature = +100°C

FREQ. (MHz)	INSERTION LOSS		COUPLING		DIRECTIVITY		RETURN LOSS			
	(dB)		(dB)		(dB)		(dB)			
	IN-OUT	FWD-REV	IN-FWD	OUT-REV	IN-REV	OUT-FWD	IN	OUT	FWD	REV
500	0.25	0.25	20.91	20.93	29.46	29.76	39.34	40.69	36.15	35.83
600	0.28	0.29	19.49	19.51	30.94	30.93	40.86	41.39	35.44	34.90
700	0.32	0.33	18.33	18.36	31.90	31.95	41.75	42.67	34.77	34.52
790	0.36	0.36	17.47	17.50	33.34	32.83	43.91	42.61	34.02	33.50
800	0.36	0.36	17.38	17.41	33.68	33.00	43.80	42.34	33.77	33.36
900	0.39	0.40	16.58	16.61	33.83	33.70	40.85	40.26	32.17	31.85
1000	0.43	0.44	15.91	15.94	32.67	32.17	36.56	36.54	30.40	30.15
1100	0.47	0.48	15.34	15.38	30.51	29.94	33.30	33.38	28.62	28.54
1200	0.50	0.52	14.87	14.91	28.52	27.65	30.28	30.50	27.18	27.24
1250	0.52	0.54	14.67	14.71	27.53	26.82	29.19	29.34	26.55	26.73
1300	0.54	0.56	14.48	14.52	26.28	25.90	27.86	28.02	25.68	25.87
1350	0.55	0.57	14.32	14.37	25.29	24.99	26.76	26.92	25.04	25.14
1400	0.57	0.59	14.17	14.21	24.59	24.11	25.84	26.02	24.48	24.56
1500	0.60	0.62	13.92	13.97	23.06	22.92	24.35	24.56	23.22	23.36
1600	0.64	0.66	13.73	13.78	22.01	21.65	22.95	23.13	22.44	22.46
1700	0.67	0.69	13.60	13.65	20.69	20.37	21.54	21.71	21.36	21.40
1800	0.70	0.72	13.52	13.57	19.67	19.31	20.47	20.56	20.64	20.69
1850	0.72	0.73	13.49	13.54	19.14	18.94	20.01	20.10	20.32	20.49
1900	0.73	0.74	13.48	13.53	18.76	18.58	19.56	19.70	20.30	20.41
1950	0.74	0.75	13.47	13.52	18.44	18.33	19.25	19.35	20.39	20.49
2000	0.75	0.76	13.47	13.52	18.09	17.98	19.00	19.09	20.23	20.41
2050	0.77	0.77	13.49	13.54	17.75	17.57	18.80	18.91	20.00	20.23
2100	0.77	0.78	13.51	13.56	17.48	17.33	18.63	18.73	20.03	20.16
2150	0.79	0.79	13.55	13.60	17.22	16.95	18.49	18.63	20.05	20.07
2200	0.79	0.80	13.60	13.65	16.85	16.68	18.42	18.49	19.90	20.00
2250	0.80	0.80	13.65	13.70	16.55	16.29	18.26	18.32	20.06	20.14
2300	0.81	0.80	13.70	13.76	16.30	16.06	18.08	18.20	20.63	20.72
2350	0.81	0.80	13.77	13.84	16.01	15.92	18.10	18.24	21.21	21.36
2400	0.81	0.81	13.85	13.90	15.83	15.82	18.29	18.35	21.35	21.62
2450	0.82	0.81	13.94	13.99	15.61	15.70	18.55	18.57	21.91	22.17
2500	0.82	0.81	14.06	14.09	15.42	15.46	18.68	18.72	22.34	22.49
2550	0.82	0.82	14.19	14.22	15.20	14.96	18.81	18.94	22.55	22.52
2600	0.82	0.81	14.33	14.38	14.90	14.47	19.11	19.14	23.20	23.37
2700	0.82	0.82	14.59	14.63	14.69	14.10	19.74	19.84	25.91	26.11
2800	0.80	0.82	14.97	15.01	14.20	13.98	20.97	21.07	28.35	29.60
2900	0.81	0.82	15.36	15.43	13.79	13.55	22.43	22.77	35.83	39.14
3000	0.79	0.82	15.82	15.86	14.00	13.63	24.68	25.39	34.14	43.54
3250	0.78	0.85	17.45	17.48	13.60	12.90	30.43	36.07	24.25	24.66
3500	0.79	0.88	19.91	20.01	11.80	11.38	27.93	28.39	19.70	19.75
3750	0.82	0.94	23.59	23.66	9.59	9.14	25.05	24.66	18.01	18.08
4000	0.84	0.98	30.49	30.54	2.18	2.23	26.46	25.99	17.95	18.13
4250	0.85	0.96	41.40	40.27	9.43	10.53	42.31	34.86	21.62	21.75
4500	0.91	0.97	27.36	27.31	1.52	1.55	29.30	28.56	31.22	31.20
4750	1.01	1.05	22.53	22.72	4.70	4.79	20.99	20.87	27.55	26.62
5000	1.09	1.13	20.21	20.41	6.34	6.56	18.34	18.44	20.42	20.46
5250	1.18	1.27	18.67	18.95	7.59	8.02	17.32	17.42	16.92	17.34
5500	1.23	1.36	17.90	18.19	8.30	8.90	17.89	17.82	15.98	16.22
5750	1.23	1.43	17.39	17.70	9.57	9.72	21.07	20.80	15.50	15.78
6000	1.26	1.46	17.07	17.36	10.99	10.70	25.22	25.54	15.83	15.91
6500	1.32	1.46	17.03	17.33	14.02	12.20	27.51	28.58	17.98	17.09
7000	1.51	1.54	17.16	17.27	15.48	15.30	18.66	18.91	23.33	22.91
7500	1.79	1.78	16.69	16.87	13.18	13.69	14.09	14.04	22.56	22.36
8000	2.15	2.58	15.38	15.52	5.48	6.72	12.11	11.72	11.08	11.62

REV. X1

BDCA-15-25+

081007

Page 3 of 3



IF/RF MICROWAVE COMPONENTS • ISO 9001 ISO 14001 AS 9100 CERTIFIED • RoHS compliant

P.O. Box 350166, Brooklyn, New York 11235-0003 (718) 934-4500 Fax (718) 332-4661



The Design Engineers Search Engine finds the model you need, Instantly • For detailed performance specs & shopping online see



Bi-Directional Coupler

BDCA-15-25+

Typical Performance Curves

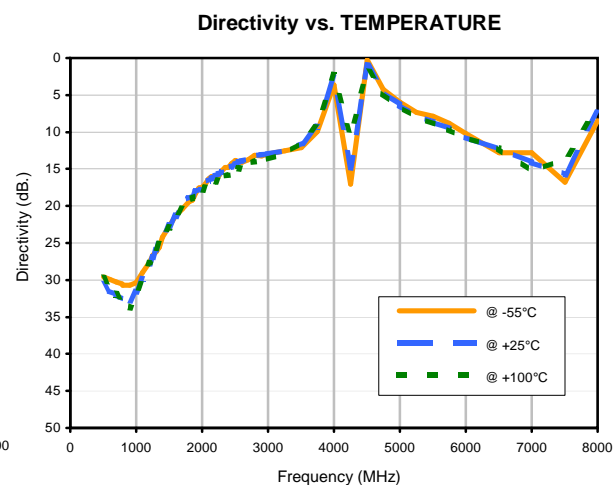
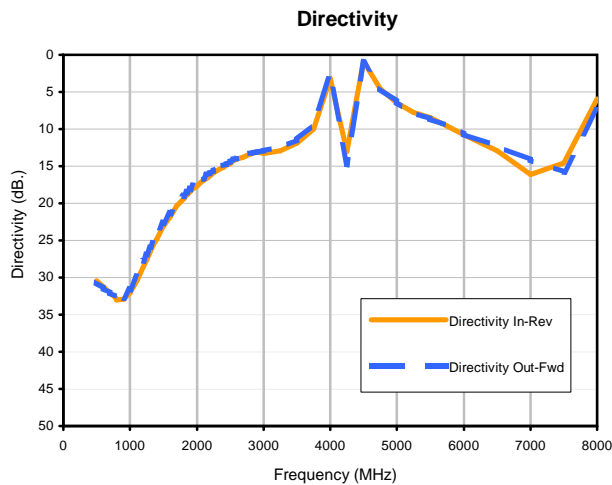
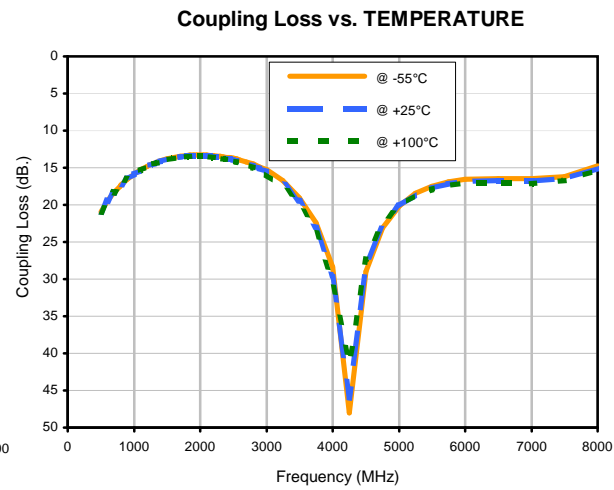
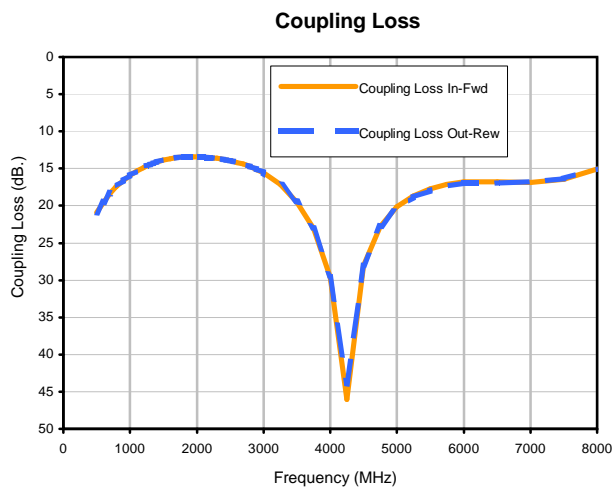
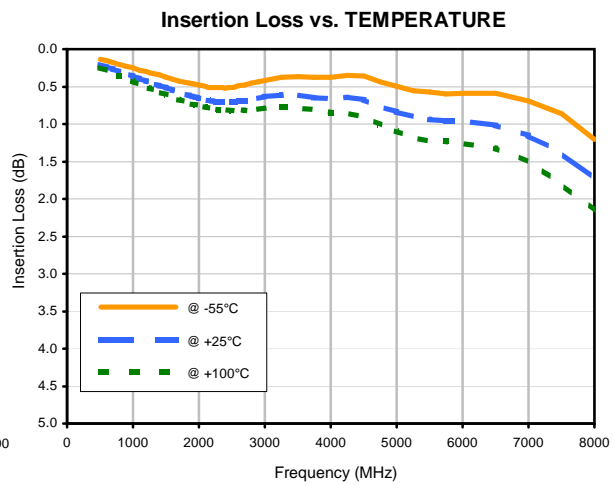
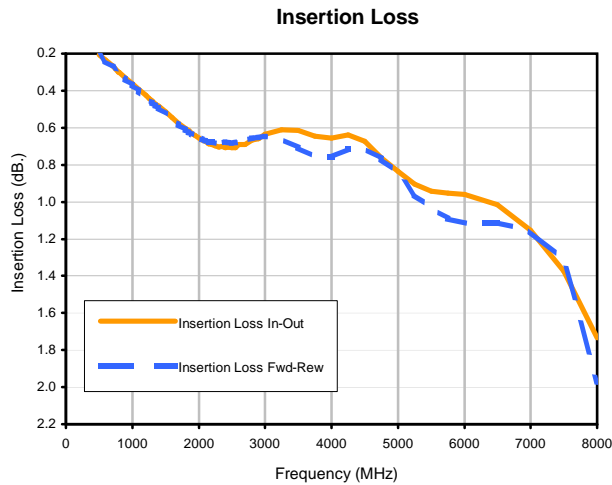

REV. X1
BDCA-15-25+
081007
Page 1 of 2



IF/RF MICROWAVE COMPONENTS • ISO 9001 ISO 14001 AS 9100 CERTIFIED • RoHS compliant
P.O. Box 350166, Brooklyn, New York 11235-0003 (718) 934-4500 Fax (718) 332-4661



The Design Engineers Search Engine finds the model you need, Instantly • For detailed performance specs & shopping online see



Bi-Directional Coupler

BDCA-15-25+

Typical Performance Curves

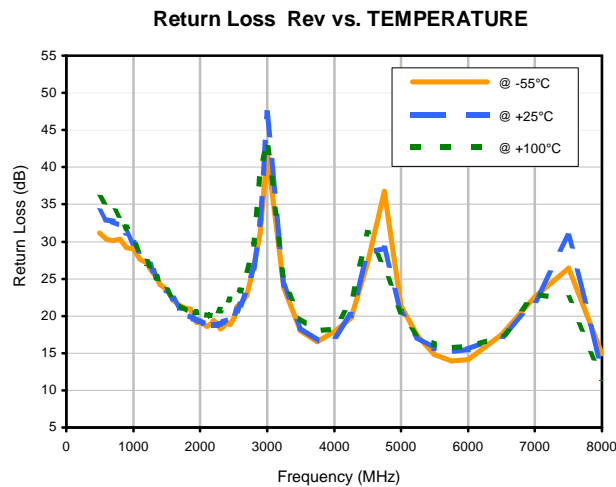
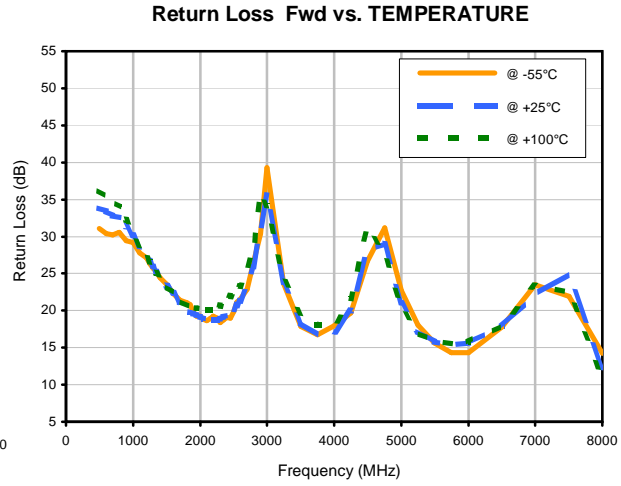
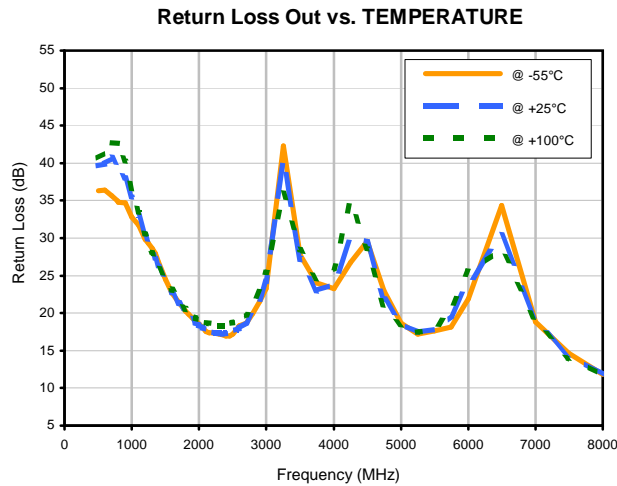
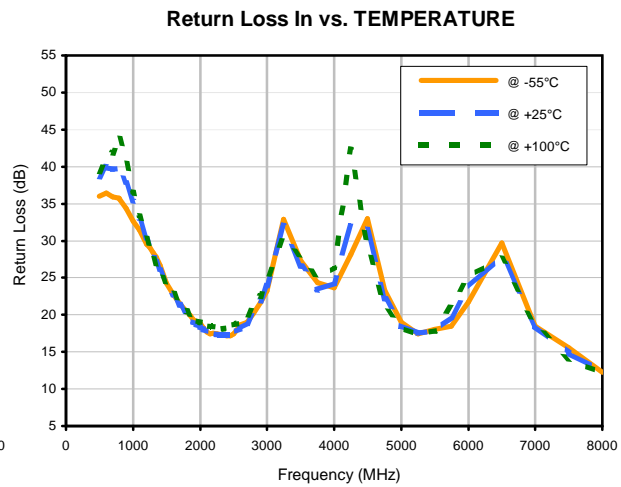
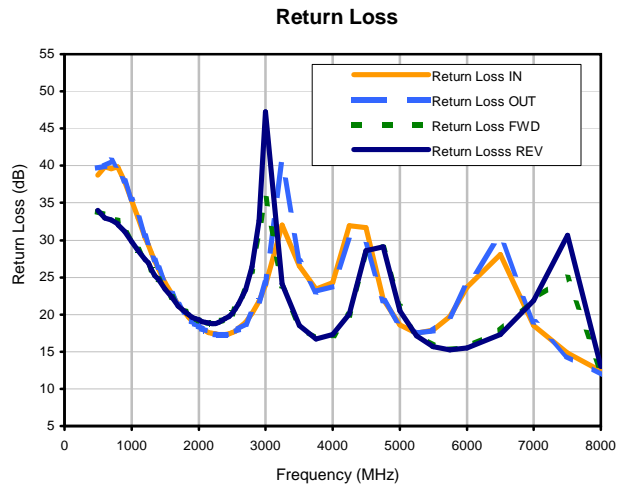

REV. X1
BDCA-15-25+
081007
Page 2 of 2



IF/RF MICROWAVE COMPONENTS • ISO 9001 ISO 14001 AS 9100 CERTIFIED • RoHS compliant
P.O. Box 350166, Brooklyn, New York 11235-0003 (718) 934-4500 Fax (718) 332-4661



The Design Engineers Search Engine finds the model you need, Instantly • For detailed performance specs & shopping online see minicircuits.com

Outline Dimensions

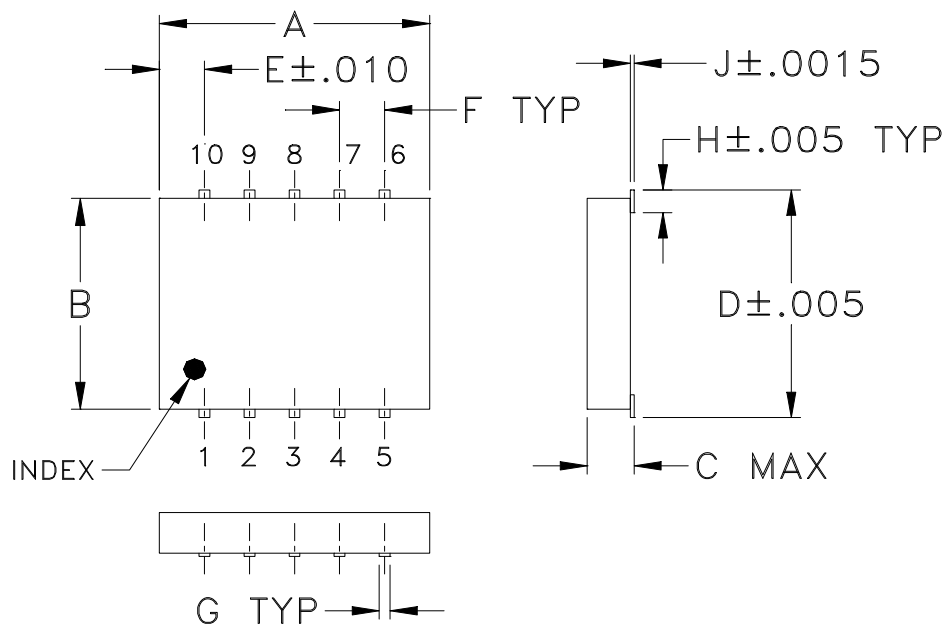

PCB Land Pattern

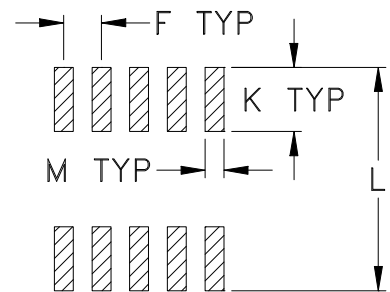

Suggested Layout,
Tolerance to be within $\pm.002$

CASE#	A	B	C	D	E	F	G	H	J	K	L	M	WT. GRAMS
DZ944	.30 (7.62)	.250 (6.35)	.052 (1.32)	.266 (6.76)	.050 (1.27)	.050 (1.27)	.012 (0.30)	.029 (0.74)	.004 (0.10)	.085 (2.16)	.296 (7.52)	.030 (0.76)	0.25

Dimensions are in inches (mm). Tolerances: 2Pl. $\pm .01$; 3Pl. $\pm .005$

Notes:

- Case material: Ceramic.
- Termination finish:
 For RoHS Case Styles: Tin plate. All models, (+) suffix.
 For RoHS-5 Case Styles: Tin-Lead plate. All models, no (+) suffix.

Tape & Reel Packaging TR-F34



Tape Width, mm	Device Cavity Pitch, mm	Reel Size, inches	Devices per Reel see note	
16	12	7	Small quantity standard (see note)	20
				50
				100
				200
		13	Standard	500
				1000

Note: Availability of small reel quantity varies by model.
Refer to pricing and availability on individual model dashboard.

Mini-Circuits carrier tape materials provide protection from ESD (Electro-Static Discharge) during handling and transportation. Tapes are static dissipative and comply with industry standards EIA-481/EIA-541.

Go to: www.minicircuits.com/pages/pdfs/tape.pdf



INTERNET <http://www.minicircuits.com>

P.O. Box 350166, Brooklyn, New York 11235-0003 (718) 934-4500 Fax (718) 332-4661

Distribution Centers NORTH AMERICA 800-654-7949 • 417-335-5935 • Fax 417-335-5945 • EUROPE 44-1252-832600 • Fax 44-1252-837010

Mini-Circuits ISO 9001 & ISO 14001 Certified

THIRD ANGLE PROJECTION

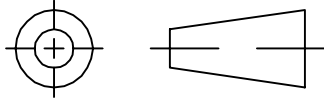

REVISIONS

REV	ECN No.	DESCRIPTION	DATE	DR	AUTH
A	M82377	UPDATED DRAWING	07/31/02	AV	DB
B	M101085	UPDATED DRAWING, ADDED DZ944 CASE STYLE & NOTE 2	10/06/05	MMG	HY
C	M102713	UPDATED NOTES	01/10/06	MMG	ABD

**SUGGESTED MOUNTING CONFIGURATION FOR
SM1L/SM33/DZ944 CASE STYLES, "lf/nl" PIN CONNECTIONS**

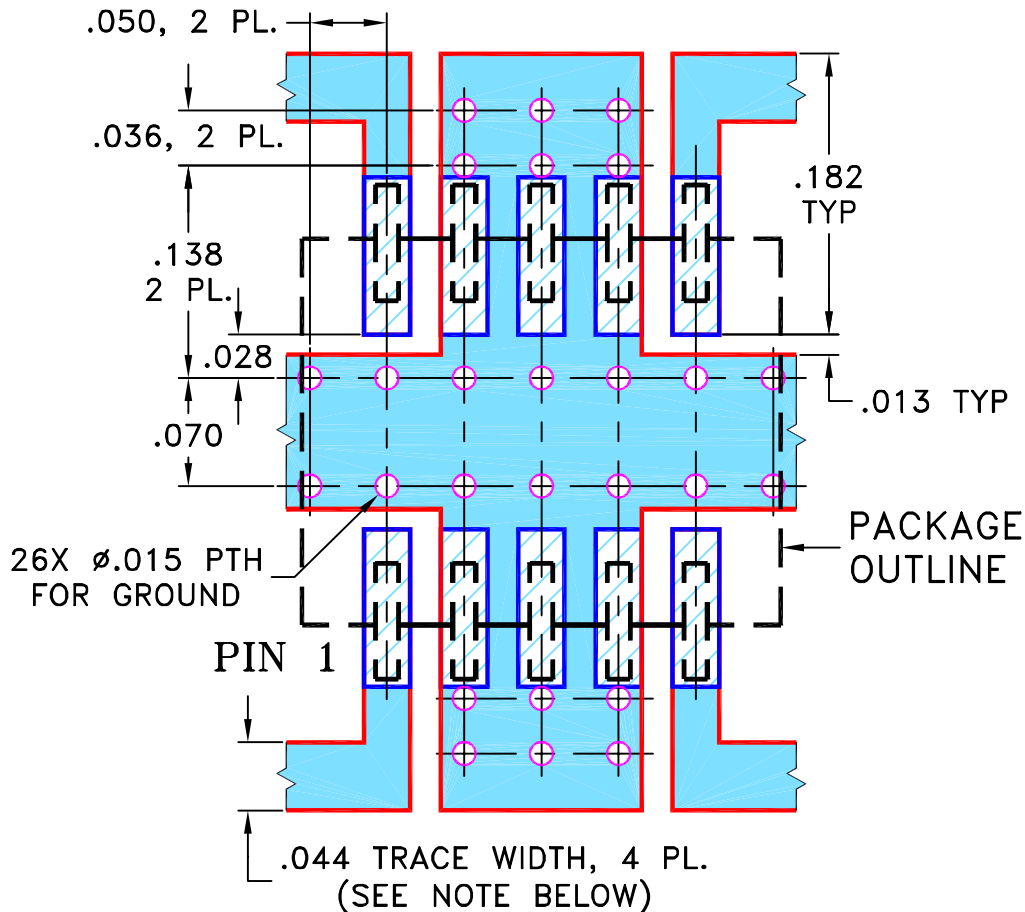

- NOTE: 1. TRACE WIDTH IS SHOWN FOR ROGERS RO4350B WITH DIELECTRIC THICKNESS $.020 \pm .0015$; COPPER: 1/2 OZ. EACH SIDE. FOR OTHER MATERIALS TRACE WIDTH MAY NEED TO BE MODIFIED.
2. BOTTOM SIDE OF THE PCB IS CONTINUOUS GROUND PLANE.

- DENOTES PCB COPPER LAYOUT WITH SMOBC (SOLDER MASK OVER BARE COPPER)
- DENOTES COPPER LAND PATTERN FREE OF SOLDER MASK

UNLESS OTHERWISE SPECIFIED	INITIALS	DATE
DIMENSIONS ARE IN INCHES	DRAWN MMG	04/12/00
TOLERANCES ON:	CHECKED WP	04/27/00
2 PL DECIMALS \pm	APPROVED DB	04/27/00
3 PL DECIMALS $\pm .005$		
ANGLES \pm		
FRACTIONS \pm		

Mini-Circuits® 13 Neptune Avenue
Brooklyn NY 11235

PL, lf/nl, SM1L/SM33/DZ944, BDCA/QBA, TB-115

SIZE A	CODE IDENT 15542	DRAWING NO: 98-PL-004	REV: C
FILE: 98PL004	SCALE: 8:1	SHEET: 1 OF 1	

Mini-Circuits®
THIS DOCUMENT AND ITS CONTENTS ARE THE PROPERTY OF MINI-CIRCUITS. EXCEPT FOR USE EXPRESSLY GRANTED, IN WRITING, TO ITS VENDORS, VENDEE AND THE UNITED STATES GOVERNMENT, MINI-CIRCUITS RESERVES ALL PROPRIETARY DESIGN, USE, MANUFACTURING AND REPRODUCTION RIGHTS THERETO. THESE CONTENTS SHALL NOT BE USED, DUPLICATED OR DISCLOSED TO ANY OUTSIDE PARTY, IN WHOLE OR IN PART, WITHOUT WRITTEN PERMISSION OF MINI-CIRCUITS.

ASHEETA1.DWG REV:A DATE:01/12/95

Evaluation Board and Circuit

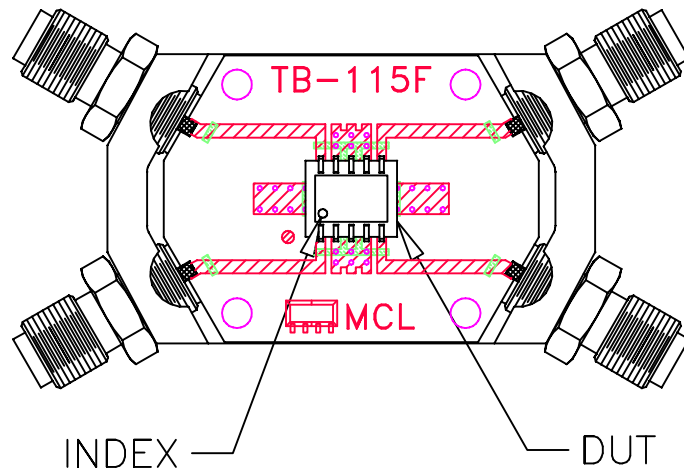

TB-115+

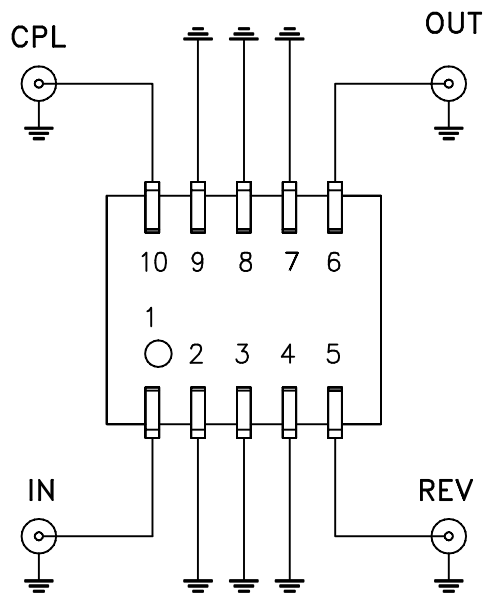

BDCA MODELS

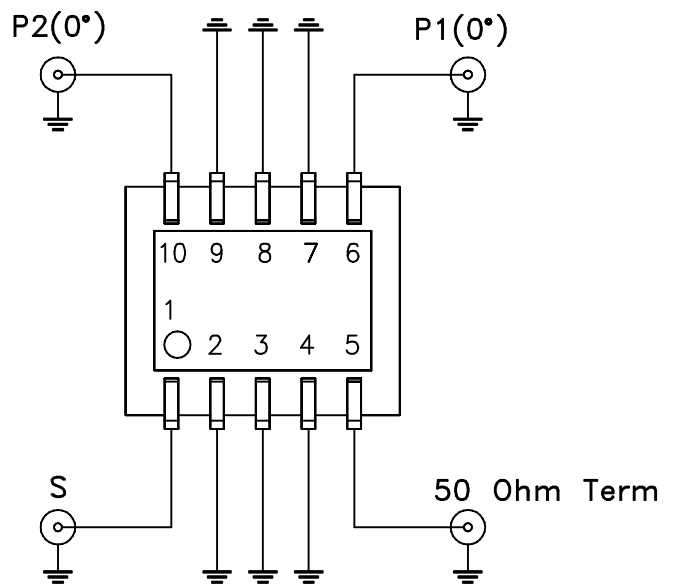

QBA MODELS

SCHEMATIC DIAGRAM

Notes:

1. SMA Female connectors.
2. PCB Material: Rogers R04350 or equivalent, Dielectric Constant=3.5, Thickness=.020 inch.



All Mini-Circuits products are manufactured under exacting quality assurance and control standards, and are capable of meeting published specifications after being subjected to any or all of the following physical and environmental test.

Specification	Test/Inspection Condition	Reference/Spec
Operating Temperature	-55° to 100°C Ambient Environment	Individual Model Data Sheet
Storage Temperature	-55° to 100° C Ambient Environment	Individual Model Data Sheet
Humidity	90 to 95% RH, 240 hours, 50°C	MIL-STD-202, Method 103, Condition A, Except 50°C and end-point electrical test done within 12 hours
Thermal Shock	-55° to 100°C, 100 cycles	MIL-STD-202, Method 107, Condition A-3, except +100°C
Solder Reflow Heat	Sn-Pb Eutetic Process: 225°C peak Pb-Free Process 245° - 250°C peak	J-STD-020, Table 4-1, 4-2 and 5-2, Figure 5-1
Solderability	10X Magnification	J-STD-002, 95% Coverage
Vibration (High Frequency)	20g peak, 10-2000 Hz, 12 times in each of three perpendicular directions (total 36)	MIL-STD-202, Method 204, Condition D
Mechanical Shock	50g, 11 ms, 1/2-sine, 18 shocks: 3 each direction, each of 3 axes	MIL-STD-202, Method 213, Condition A
Marking Resistance to Solvents	Isopropyl alcohol + mineral spirits at 25°C; terpene defluxer at 25°C; distilled water + proylene glycol monomethyl ether + monoethanolamine at 63°C to 70°C	MIL-STD-202, Method 215