

# LTCC Balun RF Transformer

50Ω 4900 to 5950 MHz 1:4 Ratio

## BLJC4-542R+



Generic photo used for illustration purposes only

CASE STYLE: JC0603C

### Maximum Ratings

Operating Temperature	-40°C to 85°C
Storage Temperature*	-40°C to 85°C
Input RF Power**	0.5W at 25°C

\*Refer to product storage temperature after installation. Suggestion for T&R unused product storage condition: +5--35°C, Humidity 45-75%RH, 12 Month max. Permanent damage may occur if any of these limits are exceeded. \*\*Derate linearly to 0.25W at 85°C.

### Pad Connections

PRIMARY DOT (Unbalanced Port)	1
GND or DC FEED	2
SECONDARY DOT (Balanced)	3
SECONDARY (Balanced)	4
NO CONNECTION	6
GND	5

### Outline Drawing

PCB Land Pattern

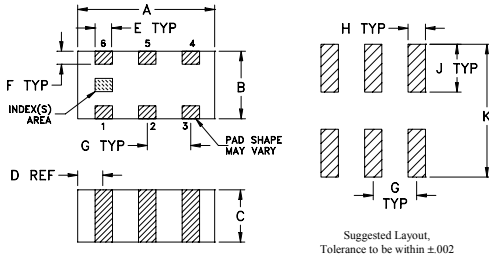

### Outline Dimensions (inch/mm)

A	B	C	D	E	F	
.063	.031	.024	.012	.008	.006	
1.60	0.79	0.61	0.30	0.20	0.15	
G	H	J	K			wt
.020	.010	.022	.053			grams
0.51	0.25	0.56	1.35			0.005

### Features

- miniature size 0603 (0.063" [1.6mm] x 0.031" [0.8mm] x 0.024" [0.6mm])
- low cost
- aqueous washable

### Applications

- ISM Band
- WLAN
- Bluetooth
- Zigbee

**+RoHS Compliant**  
The +Suffix identifies RoHS Compliance. See our web site for RoHS Compliance methodologies and qualifications

**Available Tape and Reel at no extra cost**

Reel Size	Devices/Reel
7"	20, 50, 100, 200, 500, 1000, 4000

### Electrical Specifications at 25°C

Parameter	Frequency (MHz)	Min.	Typ.	Max.	Unit
Impedance Ratio			4		
Frequency Range		4900	—	5950	MHz
Insertion Loss*	4900 - 5950	—	0.9	1.2	dB
Amplitude Unbalance	4900 - 5950	—	0.2	2	dB
Phase Unbalance†	4900 - 5950	—	0.8	14	Degree
Unbalance Return Loss	4900 - 5950	9.5	24	—	dB

\* Tested on Evaluation Board TB-1015+

† Relative to 180°

### Typical Performance Data at 25°C\*\*

FREQUENCY (GHz)	INSERTION LOSS (dB)	INPUT R. LOSS (dB)	AMPLITUDE UNBALANCE (dB)	PHASE UNBALANCE (Deg.)
4.90	0.87	12.00	0.36	11.13
5.00	0.77	13.37	0.27	11.03
5.10	0.69	15.03	0.17	10.94
5.20	0.63	17.09	0.12	10.65
5.30	0.58	19.53	0.05	10.26
5.40	0.55	22.22	0.02	9.87
5.50	0.54	23.05	0.04	9.48
5.60	0.55	20.89	0.05	8.74
5.70	0.57	18.17	0.02	7.47
5.80	0.61	15.99	0.01	6.51
5.95	0.70	13.54	0.07	3.98

\*\* Measured with Agilent E5071B network analyzer using impedance conversion and port extension.

### Evaluation Board MCL P/N: TB-1015+ Suggested PCB Layout (PL-561)

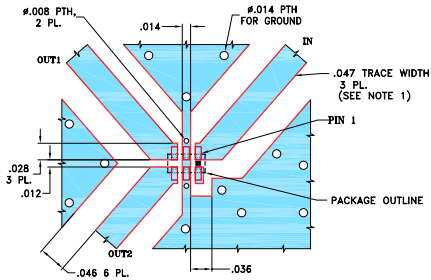

- NOTES:
1. TRACE WIDTH IS SHOWN FOR ROGERS RO4233 WITH DIELECTRIC THICKNESS .0026-.0015. COPPER: 1/2 OZ. EACH SIDE. FOR OTHER MATERIALS TRACE WIDTH & GAP MAY NEED TO BE MODIFIED.
  2. BOTTOM SIDE OF THE PCB IS CONTINUOUS GROUND PLANE.
- DENOTES PCB COPPER LAYOUT WITH SMOBC (SOLDER MASK OVER BARE COPPER).
- DENOTES COPPER LAND PATTERN FREE OF SOLDER MASK.

### Notes

- A. Performance and quality attributes and conditions not expressly stated in this specification document are intended to be excluded and do not form a part of this specification document.
- B. Electrical specifications and performance data contained in this specification document are based on Mini-Circuit's applicable established test performance criteria and measurement instructions.
- C. The parts covered by this specification document are subject to Mini-Circuits standard limited warranty and terms and conditions (collectively, "Standard Terms"); Purchasers of this part are entitled to the rights and benefits contained therein. For a full statement of the Standard Terms and the exclusive rights and remedies thereunder, please visit Mini-Circuits' website at [www.minicircuits.com/MCLStore/terms.jsp](http://www.minicircuits.com/MCLStore/terms.jsp)

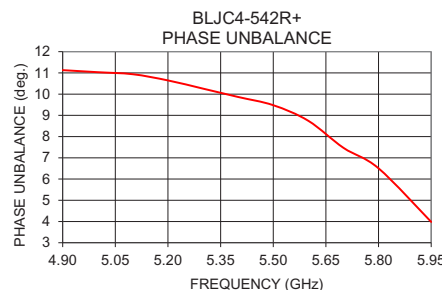
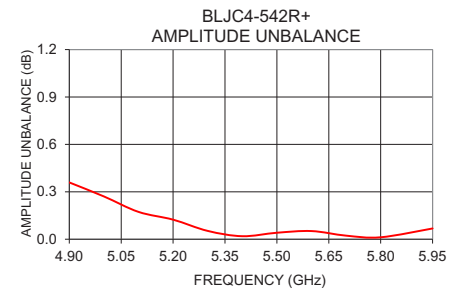
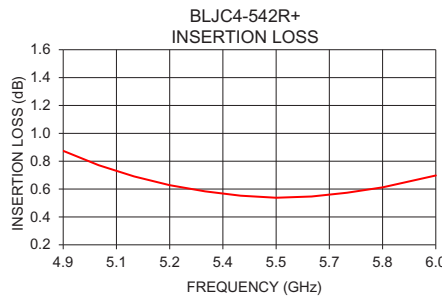

### Configuration J

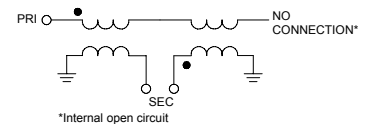

\*Internal open circuit



*Typical Performance Data*

FREQUENCY (MHz)	AVERAGE INSERTION LOSS (dB)	INPUT RETURN LOSS (dB)	AMPLITUDE UNBALANCE (dB)	PHASE UNBALANCE <sup>(1)</sup> (deg.)
4900	0.87	12.00	0.36	11.13
4925	0.84	12.33	0.35	11.09
4950	0.81	12.66	0.32	10.99
4975	0.79	13.01	0.30	11.07
5000	0.77	13.37	0.27	11.03
5025	0.75	13.74	0.23	11.07
5050	0.73	14.13	0.23	11.02
5075	0.71	14.57	0.21	10.85
5100	0.69	15.03	0.17	10.94
5125	0.67	15.49	0.16	10.99
5150	0.65	15.98	0.15	10.86
5175	0.64	16.53	0.14	10.80
5200	0.63	17.09	0.12	10.65
5225	0.62	17.69	0.08	10.66
5250	0.59	18.35	0.07	10.67
5275	0.58	18.93	0.08	10.44
5300	0.58	19.53	0.05	10.26
5325	0.57	20.33	0.04	10.23
5350	0.55	21.11	0.01	10.19
5375	0.55	21.69	0.00	10.11
5400	0.55	22.22	0.02	9.87
5425	0.54	22.75	0.01	9.68
5450	0.54	23.19	0.02	9.67
5475	0.53	23.33	0.03	9.55
5500	0.54	23.05	0.04	9.48
5525	0.54	22.67	0.03	9.27
5550	0.53	22.12	0.05	9.01
5575	0.54	21.52	0.06	9.00
5600	0.55	20.89	0.05	8.74
5625	0.55	20.29	0.05	8.46
5650	0.55	19.57	0.03	8.28
5675	0.55	18.75	0.01	7.80
5700	0.57	18.17	0.02	7.47
5725	0.59	17.71	0.02	7.10
5750	0.59	17.10	0.04	6.81
5775	0.60	16.52	0.03	6.69
5800	0.61	15.99	0.01	6.51
5810	0.62	15.76	0.00	6.27
5880	0.65	14.60	0.03	5.10
5950	0.70	13.54	0.07	3.98

<sup>(1)</sup> Relative to 180°

## Typical Performance Data

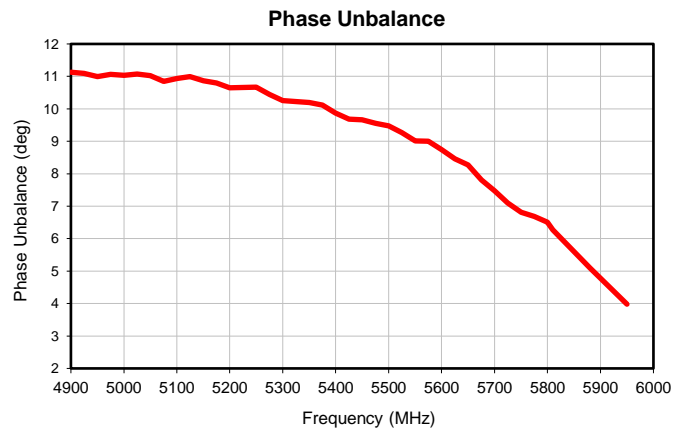
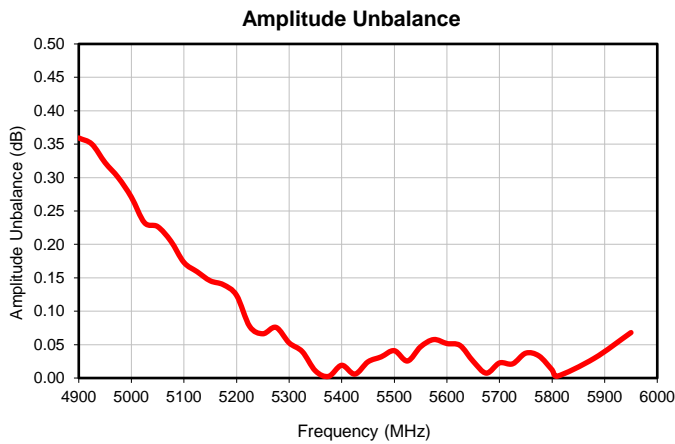
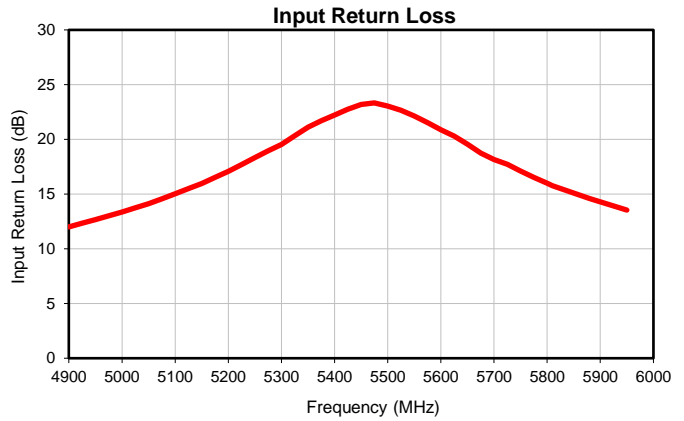
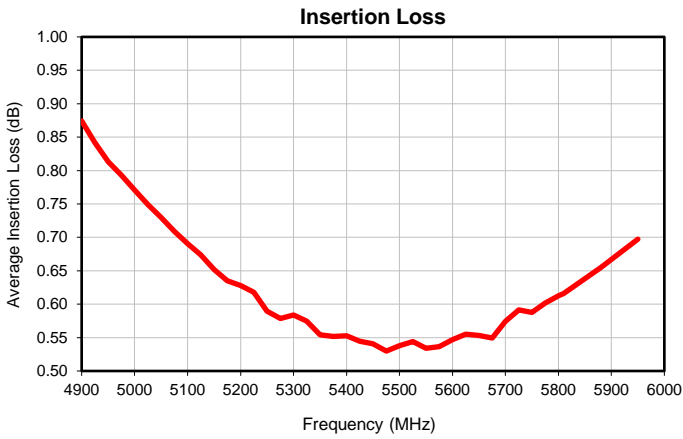



# Tape & Reel Packaging TR-F114

## DEVICE ORIENTATION IN T&R



ILLUSTRATION 1

Applicable Case Styles	
GE0805C	JC0603C
GE0805C-1	JC0603C-4
GE0805C-1AP	JC0603C-6
GE0805C-7	
GE0805C-9	
GE0805C-10	
GE0805C-11	
GE0805C-12	

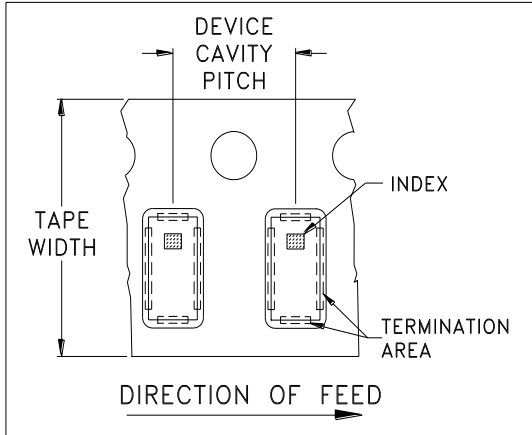

ILLUSTRATION 2

Applicable Case Styles	
GE0805C-2	JC0603C-1
GE0805C-3	JC0603C-2
GE0805C-4	JC0603C-3
GE0805C-5	JC0603C-5
GE0805C-6	JC0603C-7
GE0805C-8	
GE0805C-15	

Tape Width, mm	Device Cavity Pitch, mm	Reel Size, inches	Devices per Reel	
8	4	7	Small quantity standards (see note)	20
				50
				100
				200
				500
				1000
			Standard	4000

Note: Please Consult individual model data sheet to determine device per reel availability.

Mini-Circuits carrier tape materials provide protection from ESD (Electro-Static Discharge) during handling and transportation. Tapes are static dissipative and comply with industry standards EIA-481/EIA-541.

Go to: [www.minicircuits.com/pages/pdfs/tape.pdf](http://www.minicircuits.com/pages/pdfs/tape.pdf)



INTERNET <http://www.minicircuits.com>

P.O. Box 350166, Brooklyn, New York 11235-0003 (718) 934-4500 Fax (718) 332-4661

Distribution Centers NORTH AMERICA 800-654-7949 • 417-335-5935 • Fax 417-335-5945 • EUROPE 44-1252-832600 • Fax 44-1252-837010

Mini-Circuits ISO 9001 & ISO 14001 Certified

THIRD ANGLE PROJECTION

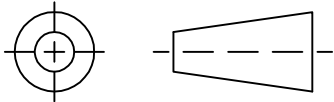

REVISIONS

REV	ECN No.	DESCRIPTION	DATE	DR	AUTH
OR	M168200	NEW RELEASE	05/31/18	NP	SL

**SUGGESTED MOUNTING CONFIGURATION  
FOR JC0603C CASE STYLE, "06TJ08" PIN CODE**

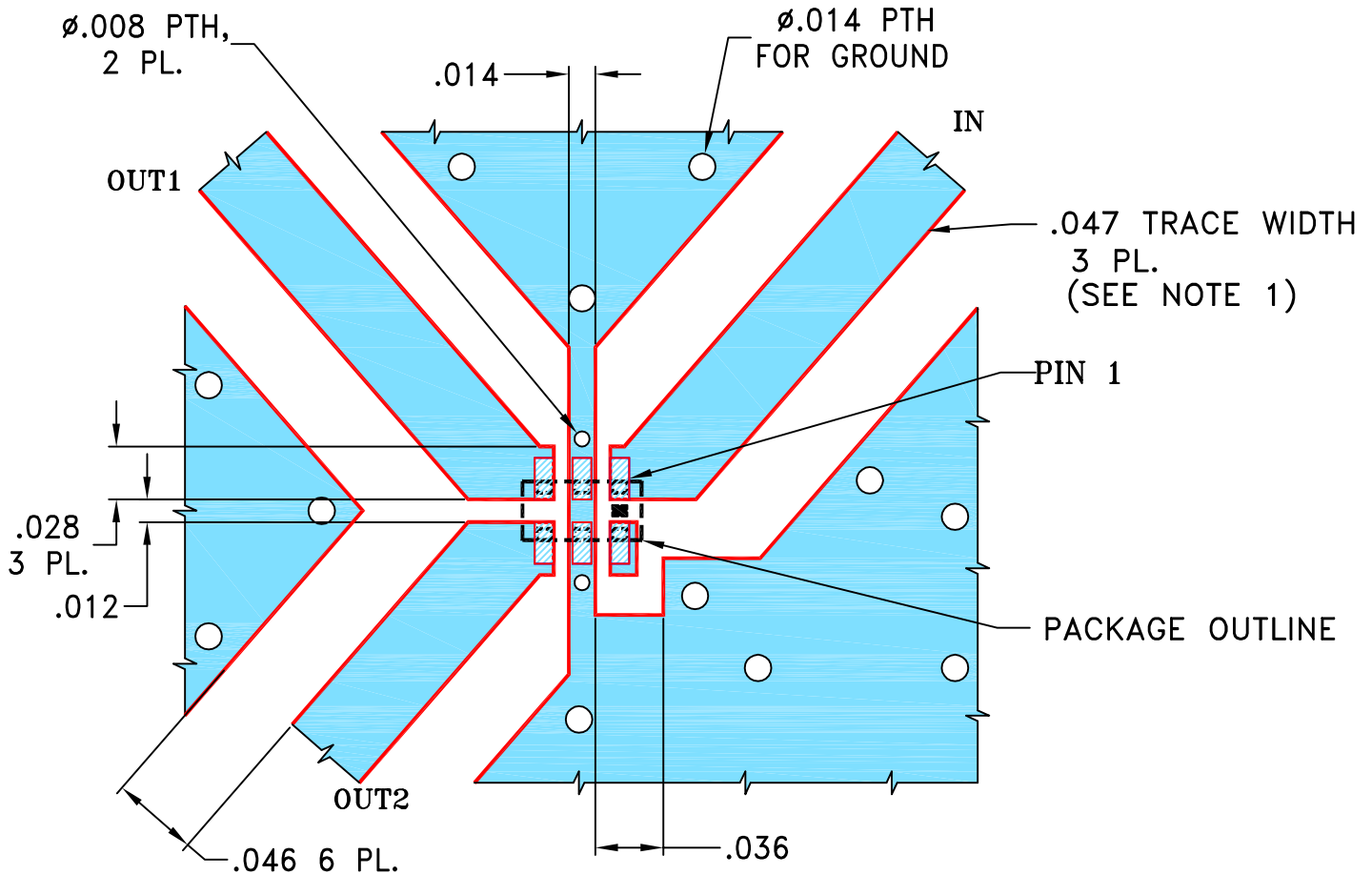

**NOTES:**

- TRACE WIDTH IS SHOWN FOR ROGERS R04233 WITH DIELECTRIC THICKNESS  $.020 \pm .0015$ . COPPER: 1/2 OZ. EACH SIDE. FOR OTHER MATERIALS TRACE WIDTH & GAP MAY NEED TO BE MODIFIED.
- BOTTOM SIDE OF THE PCB IS CONTINUOUS GROUND PLANE.



DENOTES PCB COPPER LAYOUT WITH SMOBC (SOLDER MASK OVER BARE COPPER).



DENOTES COPPER LAND PATTERN FREE OF SOLDER MASK.

UNLESS OTHERWISE SPECIFIED	INITIALS	DATE
DIMENSIONS ARE IN INCHES	DRAWN NP	05/30/18
TOLERANCES ON:	CHECKED GF	05/30/18
2 PL DECIMALS ±	APPROVED SL	05/31/18
3 PL DECIMALS ± .005		
ANGLES ±		
FRACTIONS ±		

 **Mini-Circuits®** 13 Neptune Avenue  
Brooklyn NY 11235

**PL, 06TJ08, JC0603C, TB-1015+**

SIZE	CODE IDENT	DRAWING NO:	REV:
A	15542	98-PL-561	OR
FILE:	98PL561	SCALE: 10:1	SHEET: 1 OF 1

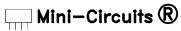
 **Mini-Circuits®**  
THIS DOCUMENT AND ITS CONTENTS ARE THE PROPERTY OF MINI-CIRCUITS. EXCEPT FOR USE EXPRESSLY GRANTED, IN WRITING, TO ITS VENDORS, VENDEE AND THE UNITED STATES GOVERNMENT, MINI-CIRCUITS RESERVES ALL PROPRIETARY DESIGN, USE, MANUFACTURING AND REPRODUCTION RIGHTS THERETO. THESE CONTENTS SHALL NOT BE USED, DUPLICATED OR DISCLOSED TO ANY OUTSIDE PARTY, IN WHOLE OR IN PART, WITHOUT WRITTEN PERMISSION OF MINI-CIRCUITS.  
ASHEETA1.DWG REV:A DATE:01/12/95



All Mini-Circuits products are manufactured under exacting quality assurance and control standards, and are capable of meeting published specifications after being subjected to any or all of the following physical and environmental test.

Specification	Test/Inspection Condition	Reference/Spec
Operating Temperature	-40° to 85° C Ambient Environment	Individual Model Data Sheet
Storage Temperature	-40° to 85° C Ambient Environment	Individual Model Data Sheet
Humidity	90 to 95% RH, 240 hours, 50°C	MIL-STD-202, Method 103, Condition A, Except 50°C and end-point electrical test done within 12 hours
Thermal Shock	-55° to 100°C, 100 cycles	MIL-STD-202, Method 107, Condition A-3, except +100°C
Solder Reflow Heat	Sn-Pb Eutectic Process: 225°C peak Pb-Free Process: 250°C peak	J-STD-020C, Table 4-1, 4-2 and 5-2; Figure 5-1
Solderability	10X Magnification	J-STD-002, Para 4.2.5, Test S, 95% Coverage
Vibration (High Frequency)	20g peak, 10-2000 Hz, 12 times in each of three perpendicular directions (total 36)	MIL-STD-202, Method 204, Condition D
Mechanical Shock	50g, 11 ms, 1/2-sine, 18 shocks: 3 each direction, each of 3 axes	MIL-STD-202, Method 213, Condition A