

Wideband, High Dynamic Range, Ceramic

Monolithic Amplifier

CMA-82+

50Ω

DC to 7 GHz

The Big Deal

- Ceramic, hermetically sealed, nitrogen filled
- Low profile case, 0.045”
- High IP3, +42 dBm
- High POUT, +20 dBm



CASE STYLE: DL1721

*MIL Screening Available
Please consult Applications Dept.*

Product Overview

Mini-Circuits' CMA-82+ is a wideband monolithic amplifier providing high dynamic range. It uses patented, Transient Protection Darlington Configuration circuit architecture and is fabricated using InGaP HBT technology. The amplifier is bonded to a multilayer integrated LTCC substrate, then hermetically sealed under a controlled Nitrogen atmosphere with gold-plated cover, eutectic Au-Sn solder, and Ni-Pd-Au termination finish. CMA-series amplifiers are capable of meeting MIL requirements for gross leak, fine leak, thermal shock, vibration, acceleration, mechanical shock, and HTOL. The testing can be done if requested.

Key Features

Feature	Advantages
Hermetically Sealed	Ideal for use anywhere long-term reliability adds bottom-line value: high moisture areas, busy production lines, high-speed distribution centers, heavy industry, outdoor settings, and unmanned facilities, as well as military applications.
Wideband, DC to 7 GHz	The amplifier covers the primary wireless communications bands including cellular, PCS, LTE, WiMAX, and satellite IF.
High IP3 vs. DC power consumption <ul style="list-style-type: none">• +42 dBm at 0.1 GHz• +39 dBm at 1 GHz	The CMA-82+ matches industry leading IP3 performance relative to device size and power consumption. The combination of the design and HBT structure provides enhanced linearity over a broad frequency range. This feature makes the amplifier ideal for use in: <ul style="list-style-type: none">• Driver amplifiers for complex waveform upconverter paths• Drivers in linearized transmit systems
Saturated output power up to +20 dBm at P1dB	The amplifier delivers high output power with low DC power consumption.
No external matching components required	CMA-82+ provides input return loss 14- 35 dB and output return loss up to 8.7-16.7 dB without the need for external matching components, simplifying board layouts and saving space.
Ceramic, hermetic package	Low inductance, repeatable performance, outstanding reliability in tough operating conditions, and small size (0.12 x 0.12 x 0.045”)



Wideband, High Dynamic Range, Ceramic Monolithic Amplifier

DC-7 GHz

Product Features

- Ceramic, hermetically sealed, high reliability
- Low profile case, .045" high
- Ruggedized design
- Gain, 15 dB typ. at 100 MHz
- High Pout, P1dB 20 dBm typ.
- High IP3, 42 dBm typ. at 100 MHz
- Transient protected, US patent 6,943,629



Generic photo used for illustration purposes only

CASE STYLE: DL1721

CMA-82+

Typical Applications

- High Rel Systems
- Defense and Aerospace
- Base station infrastructure
- LTE
- Point to Point Wireless

+RoHS Compliant

The +Suffix identifies RoHS Compliance. See our web site for RoHS Compliance methodologies and qualifications

General Description

CMA-82+ (RoHS compliant) is a wideband amplifier offering high dynamic range. It uses patented Transient Protection Darlington configuration and is fabricated using InGaP HBT technology. The MMIC amplifier is bonded to a multilayer integrated LTCC substrate and then hermetically sealed under a controlled Nitrogen atmosphere with gold plated cover and eutectic Au-Sn solder. Terminal finish is Ni-Pd-Au. It has repeatable lot to lot performance due to tightly controlled semiconductor and assembly processes. These amplifiers are capable of meeting MIL requirements and have been tested for hermeticity.

simplified schematic and pin description

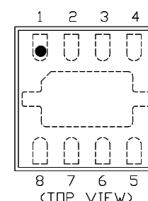
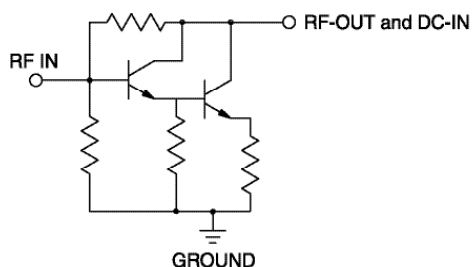

Function	Pin Number	Description
RF IN	2	RF input pin. This pin requires the use of an external DC blocking capacitor chosen for the frequency of operation.
RF-OUT and DC-IN	7	RF output and bias pin. DC voltage is present on this pin; therefore a DC blocking capacitor is necessary for proper operation. An RF choke is needed to feed DC bias without loss of RF signal due to the bias connection, as shown in "Recommended Application Circuit", Fig. 2
GND	1,3,4,5,6,8 bottom center paddle	Connections to ground. Use via holes as shown in "Suggested Layout for PCB Design" to reduce ground path inductance for best performance.



Electrical Specifications⁽¹⁾ at 25°C and 5V, unless noted

Parameter	Condition (GHz)	Min.	Typ.	Max.	Units
Frequency Range ⁽²⁾		DC		7	GHz
Gain	0.1	13.7	15.5	16.8	dB
	1.0	—	15.1	—	
	2.0	12.2	14.1	15.2	
	3.0	—	13.0	—	
	4.0	9.8	12.0	13.0	
	6.0	—	10.2	—	
	7.0	—	9.2	—	
Magnitude of Gain Variation versus Temperature ⁽³⁾ (values are negative)	0.1	—	0.0002	—	dB/°C
	1.0	—	0.0012	—	
	2.0	—	0.0020	0.005	
	3.0	—	0.0027	—	
	4.0	—	0.0037	—	
	6.0	—	0.0062	—	
	7.0	—	0.0108	—	
Input Return Loss	0.1	—	35.0	—	dB
	1.0	—	19.0	—	
	2.0	13.0	16.0	—	
	3.0	—	14.0	—	
	4.0	—	14.0	—	
	6.0	—	15.5	—	
	7.0	—	14.4	—	
Output Return Loss	0.1	—	16.7	—	dB
	1.0	—	13.2	—	
	2.0	8.0	10.0	—	
	3.0	—	8.8	—	
	4.0	—	8.7	—	
	6.0	—	9.8	—	
	7.0	—	10.5	—	
Reverse Isolation	2.0	—	23.4	—	dB
Output Power @ 1 dB compression	0.1	18.0	20.0	—	dBm
	1.0	18.0	20.0	—	
	2.0	18.0	20.6	—	
	3.0	—	20.0	—	
	4.0	—	20.3	—	
	6.0	—	19.0	—	
	7.0	—	18.2	—	
Output IP3	0.1	—	42.0	—	dBm
	1.0	—	39.0	—	
	2.0	34.0	36.4	—	
	3.0	—	34.5	—	
	4.0	—	33.2	—	
	6.0	—	30.6	—	
	7.0	—	30.1	—	
Noise Figure	0.1	—	6.4	8.0	dB
	1.0	—	6.5	—	
	2.0	—	6.7	8.2	
	3.0	—	6.8	—	
	4.0	—	6.9	—	
	6.0	—	7.3	—	
	7.0	—	7.5	—	
Group Delay	2.0	—	100	—	psec
Device Operating Voltage		4.8	5.0	5.2	V
Device Operating Current		90	106	120	mA
Device Current Variation vs. Temperature			70.5		µA/°C
Device Current Variation vs Voltage			0.038		mA/mV
Thermal Resistance, junction-to-ground lead			93		°C/W

⁽¹⁾ Measured on Mini-Circuits test board TB-829-82+. See Characterization Test Circuit (Fig. 1)

⁽²⁾ Low frequency cut off determined by external coupling capacitors and RF Choke (RFC).

⁽³⁾ (Gain at 85°C, Gain at -45°C)/130

Absolute Maximum Ratings

Parameter	Ratings
Operating Temperature (ground lead)	-40°C to 85°C
Storage Temperature	-65°C to 150°C
Operating Current at 5V	160mA
Power Dissipation	0.84W
Input Power	20 dBm
DC Voltage on Pin 3	5.8V

Note:
 Permanent damage may occur if any of these limits are exceeded.
 Electrical maximum ratings are not intended for continuous normal operation.

Characterization Test Circuit

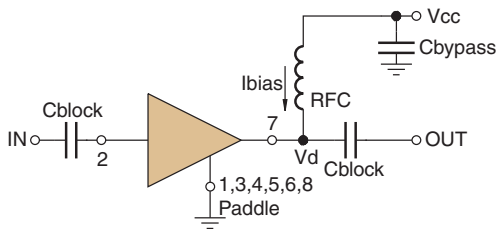
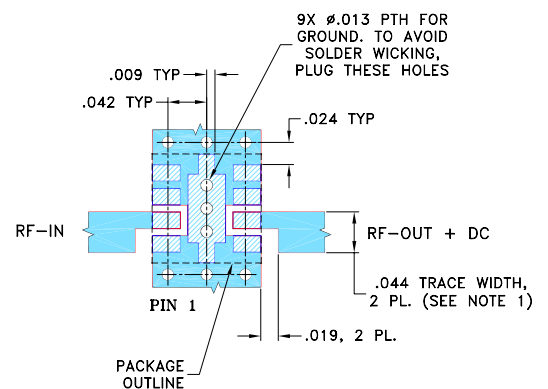

Fig 1. Block Diagram of Test Circuit used for characterization. (DUT soldered on Mini-Circuits Test Board TB-829-82+)

Gain, Output power at 1dB compression (P1 dB) and output IP3 (OIP3) are measured using R&S Network Analyzer ZVA-24.
 Noise Figure measured using Agilent's N5242A PNA-X microwave network analyzer.

- Conditions:**
- Gain and Return loss: Pin= -25dBm

Suggested PCB Layout (PL-366)



- NOTES:**
- TRACE WIDTH IS SHOWN FOR ROGERS RO4350B WITH DIELECTRIC THICKNESS .020" ± .0015"; COPPER: 1/2 OZ. EACH SIDE. FOR OTHER MATERIALS TRACE WIDTH AND GAP MAY NEED TO BE MODIFIED.
 - BOTTOM SIDE OF THE PCB IS CONTINUOUS GROUND PLANE.
-

Product Marking

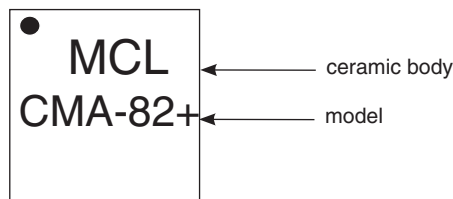

Additional Detailed Technical Information	
<i>additional information is available on our dash board. To access this information click here</i>	
Performance Data	Data Table
	Swept Graphs
	S-Parameter (S2P Files) Data Set (.zip file)
Case Style	DL1721 <i>Ceramic package, exposed paddle, Terminal finish: Ni,Pd,Au</i>
Tape & Reel Standard quantities available on reel	F66-1 <i>7" reels with 20, 50, 100, 200, 500 or 1K, 2K devices.</i>
Suggested Layout for PCB Design	PL-366
Evaluation Board	TB-656-82+
Environmental Ratings	ENV-68

ESD Rating

Human Body Model (HBM): Class 1C (1000 to <2000V) in accordance with ANSI/ESD STM 5.1 - 2001

Machine Model (MM): Class M2 (100 to <200V) in accordance with ANSI/ESD STM5.2-1999

MSL Rating

Moisture Sensitivity: MSL1 (these parts are hermetic, air cavity and therefore, MSL ratings do not strictly apply. For handling purpose, use MSL1)

Qualification Testing

The table below shows the initial qualification testing performed. If required, parts can be subjected to 100% screening and qualifications testing per MIL standard requirement.

Test Description		Test Method/Process	Results
1	Hermeticity (fine and gross leak)	MIL-STD-202 Method 112, Cond. C & D	Pass
2	Acceleration, 30Kg, Y1 Direction	MIL-STD-883 Method 2001 Cond. E	Pass
3	Vibration , 10-2000Hz sine, 20g, 3 axis	MIL-STD-202 Method 204, Cond. D	Pass
4	Mechanical shock	MIL-STD-202 Method 213, Cond . A	Pass
5	PIND 20G's @130 Hz	MIL-STD-750 Method 2052.2	Pass
6	Temp Cycle -55C/+125C, 1000 Cycles	MIL-STD-202 Method 107	Pass
7	Autoclave, 121C, RH 100%, 15 Psig, 96 hrs	JESD22-A102C	Pass
8	HTOL, 1000hrs, 105C at rated Voltage condition	MIL-STD-202 Method 108, Cond . D	Pass
9	Bend Test	JESD22-B113	Pass
10	Resistance to soldering heat, 3x reflow, 260C peak	JESD22-B102	Pass
11	Drop Test	JESD22-B111	Pass
12	Adhesion Strength	Push Test>10 lb	Pass

Additional Notes

- Performance and quality attributes and conditions not expressly stated in this specification document are intended to be excluded and do not form a part of this specification document.
- Electrical specifications and performance data contained in this specification document are based on Mini-Circuit's applicable established test performance criteria and measurement instructions.
- The parts covered by this specification document are subject to Mini-Circuits standard limited warranty and terms and conditions (collectively, "Standard Terms"); Purchasers of this part are entitled to the rights and benefits contained therein. For a full statement of the Standard Terms and the exclusive rights and remedies thereunder, please visit Mini-Circuits' website at www.minicircuits.com/MCLStore/terms.jsp



Typical Performance Data

NOTE: Use PDF Bookmarks to view DATA at required conditions

Definitions:

Input Return Loss = -S11 (dB)

Gain(Power Gain) = S21 (dB)

Reverse Isolation = -S12 (dB)

Output Return Loss = -S22 (dB)

TEST CONDITIONS: Vd = 5.00V, Id = 103.96mA @ Temperature = +25°C

FREQ	Gain	Isolation	Input Return Loss	Output Return Loss	Stability		IP-3 Output	1dB Comp. Output	Noise Figure
					K	Measure			
(MHz)	(dB)	(dB)	(dB)	(dB)	K	Measure	(dBm)	(dBm)	(dB)
20	15.52	24.35	39.26	17.21	1.54	0.85	43.29	19.46	6.66
40	15.51	24.35	38.02	17.20	1.54	0.85	43.14	20.21	6.45
60	15.50	24.32	37.99	17.19	1.54	0.85	45.67	20.31	6.46
80	15.50	24.33	36.94	17.19	1.54	0.85	41.59	20.31	6.46
100	15.50	24.33	36.46	17.15	1.54	0.85	42.55	20.21	6.44
200	15.47	24.33	32.84	16.97	1.54	0.85	42.13	20.34	6.44
300	15.44	24.30	29.96	16.65	1.54	0.85	41.39	20.45	6.60
400	15.40	24.28	27.52	16.26	1.53	0.85	42.55	20.38	6.45
500	15.36	24.25	25.89	15.83	1.53	0.85	40.15	20.49	6.50
600	15.31	24.22	24.50	15.34	1.52	0.85	41.07	20.48	6.50
700	15.25	24.17	23.19	14.83	1.52	0.85	40.40	20.42	6.50
800	15.19	24.12	22.17	14.35	1.51	0.85	38.99	20.42	6.53
900	15.12	24.06	21.30	13.87	1.50	0.85	38.99	20.28	6.52
1000	15.04	24.00	20.43	13.40	1.49	0.85	38.53	20.41	6.57
1100	14.96	23.94	19.73	12.98	1.48	0.85	38.32	20.33	6.60
1200	14.87	23.87	19.07	12.57	1.47	0.85	37.75	20.27	6.60
1250	14.83	23.83	18.81	12.38	1.47	0.84	38.11	20.26	6.61
1500	14.59	23.64	17.55	11.52	1.44	0.84	38.13	20.28	6.63
1750	14.34	23.43	16.63	10.83	1.42	0.84	37.23	20.17	6.66
2000	14.08	23.21	15.87	10.27	1.39	0.84	36.06	20.29	6.68
2250	13.81	22.99	15.35	9.85	1.38	0.84	35.79	20.24	6.73
2500	13.53	22.77	14.96	9.53	1.36	0.84	35.21	20.23	6.70
2750	13.27	22.55	14.65	9.29	1.35	0.84	34.57	20.17	6.82
3000	13.00	22.33	14.43	9.12	1.35	0.83	34.59	20.44	6.91
3250	12.75	22.10	14.30	9.05	1.34	0.84	34.64	20.38	6.90
3500	12.49	21.89	14.24	9.00	1.34	0.84	34.81	20.21	6.92
3750	12.25	21.67	14.30	9.01	1.35	0.84	33.77	20.12	6.96
4000	12.02	21.45	14.43	9.03	1.35	0.84	33.72	20.15	6.97
4250	11.78	21.25	14.66	9.08	1.36	0.84	33.42	20.26	6.96
4500	11.54	21.06	14.98	9.18	1.38	0.84	32.82	20.10	7.02
4750	11.32	20.87	15.32	9.31	1.40	0.84	32.31	19.99	7.09
5000	11.08	20.71	15.73	9.37	1.41	0.84	31.79	19.89	7.16
5250	10.84	20.54	16.11	9.45	1.43	0.84	31.81	19.75	7.13
5500	10.60	20.40	16.31	9.53	1.45	0.84	31.27	19.41	7.13
5750	10.34	20.30	16.41	9.59	1.48	0.84	31.28	19.25	7.22
6000	10.08	20.20	16.40	9.62	1.51	0.84	30.76	19.05	7.29
6250	9.81	20.12	16.20	9.61	1.54	0.84	30.86	18.86	7.33
6500	9.53	20.05	15.79	9.51	1.57	0.84	30.46	18.67	7.41
6750	9.24	19.99	15.19	9.39	1.60	0.84	30.63	18.38	7.42
7000	8.94	19.95	14.66	9.27	1.63	0.84	30.07	18.20	7.49

Typical Performance Data

Definitions:

Input Return Loss = -S11 (dB)

Gain(Power Gain) = S21 (dB)

Reverse Isolation = -S12 (dB)

Output Return Loss = -S22 (dB)

TEST CONDITIONS: Vd = 4.75V, Id = 94.72mA @ Temperature = +25°C

FREQ	Gain	Isolation	Input Return Loss	Output Return Loss	Stability		IP-3 Output	1dB Comp. Output	Noise Figure
					K	Measure			
(MHz)	(dB)	(dB)	(dB)	(dB)	K	Measure	(dBm)	(dBm)	(dB)
20	15.49	24.30	37.29	17.05	1.53	0.85	38.30	18.70	6.52
40	15.48	24.30	36.09	17.04	1.54	0.85	41.13	19.42	6.35
60	15.47	24.27	36.34	17.03	1.53	0.85	42.50	19.52	6.39
80	15.47	24.28	35.39	17.03	1.53	0.85	39.59	19.51	6.34
100	15.47	24.28	35.04	17.00	1.53	0.85	40.30	19.42	6.34
200	15.45	24.27	32.04	16.81	1.53	0.85	39.56	19.53	6.33
300	15.41	24.25	29.47	16.51	1.53	0.85	38.90	19.64	6.37
400	15.38	24.23	27.33	16.12	1.53	0.85	41.52	19.58	6.36
500	15.33	24.20	25.71	15.70	1.52	0.85	38.64	19.67	6.35
600	15.28	24.16	24.35	15.22	1.52	0.85	37.98	19.66	6.41
700	15.23	24.12	23.08	14.72	1.51	0.85	38.77	19.61	6.37
800	15.16	24.06	22.02	14.24	1.50	0.85	37.81	19.60	6.38
900	15.09	24.00	21.12	13.76	1.49	0.85	38.30	19.48	6.44
1000	15.01	23.94	20.29	13.31	1.48	0.84	37.15	19.59	6.47
1100	14.93	23.87	19.59	12.88	1.47	0.84	36.48	19.52	6.51
1200	14.84	23.80	18.93	12.48	1.46	0.84	36.78	19.46	6.51
1250	14.80	23.76	18.67	12.29	1.46	0.84	37.06	19.45	6.47
1500	14.56	23.56	17.45	11.44	1.43	0.84	35.89	19.47	6.55
1750	14.31	23.35	16.53	10.76	1.41	0.84	35.37	19.37	6.53
2000	14.04	23.13	15.78	10.21	1.39	0.84	34.60	19.48	6.61
2250	13.77	22.90	15.25	9.80	1.37	0.84	35.16	19.42	6.60
2500	13.49	22.68	14.86	9.48	1.35	0.83	34.60	19.41	6.55
2750	13.23	22.46	14.58	9.24	1.34	0.83	33.99	19.40	6.71
3000	12.96	22.23	14.36	9.09	1.34	0.83	33.56	19.58	6.80
3250	12.70	22.01	14.23	9.01	1.34	0.83	33.67	19.51	6.71
3500	12.45	21.79	14.17	8.98	1.34	0.84	33.91	19.35	6.80
3750	12.20	21.58	14.24	8.99	1.34	0.84	33.15	19.32	6.82
4000	11.97	21.36	14.38	9.01	1.35	0.84	32.76	19.39	6.83
4250	11.73	21.16	14.61	9.06	1.36	0.83	32.83	19.41	6.85
4500	11.49	20.97	14.93	9.17	1.37	0.84	32.27	19.35	6.91
4750	11.27	20.78	15.26	9.30	1.39	0.84	31.82	19.29	6.94
5000	11.03	20.61	15.68	9.37	1.41	0.84	31.30	19.28	7.01
5250	10.79	20.45	16.04	9.44	1.43	0.83	31.08	19.16	7.00
5500	10.55	20.32	16.26	9.53	1.45	0.84	30.78	18.84	7.06
5750	10.28	20.21	16.37	9.59	1.48	0.84	30.63	18.68	7.06
6000	10.03	20.12	16.35	9.63	1.51	0.84	30.26	18.53	7.15
6250	9.76	20.04	16.18	9.61	1.54	0.84	30.26	18.36	7.16
6500	9.48	19.97	15.73	9.52	1.57	0.84	30.01	18.20	7.28
6750	9.18	19.91	15.19	9.41	1.60	0.84	30.25	17.89	7.29
7000	8.89	19.88	14.63	9.28	1.63	0.84	29.72	17.81	7.36

Typical Performance Data

Definitions:

Input Return Loss = -S11 (dB)

Gain(Power Gain) = S21 (dB)

Reverse Isolation = -S12 (dB)

Output Return Loss = -S22 (dB)

TEST CONDITIONS: Vd = 5.25V, Id = 113.84mA @ Temperature = +25°C

FREQ	Gain	Isolation	Input Return Loss	Output Return Loss	Stability		IP-3 Output	1dB Comp. Output	Noise Figure
					K	Measure			
(MHz)	(dB)	(dB)	(dB)	(dB)	K	Measure	(dBm)	(dBm)	(dB)
20	15.54	24.39	42.60	17.34	1.54	0.85	46.65	20.20	6.76
40	15.53	24.39	39.73	17.34	1.54	0.85	42.10	20.96	6.55
60	15.52	24.37	39.98	17.34	1.54	0.85	45.58	21.09	6.58
80	15.52	24.37	38.50	17.33	1.54	0.85	45.57	21.08	6.57
100	15.52	24.37	37.96	17.30	1.54	0.85	44.50	20.97	6.57
200	15.50	24.37	33.48	17.10	1.54	0.85	44.04	21.11	6.55
300	15.46	24.35	30.20	16.78	1.54	0.85	45.13	21.24	6.62
400	15.43	24.32	27.81	16.37	1.54	0.85	45.38	21.16	6.54
500	15.38	24.30	26.05	15.94	1.53	0.85	44.30	21.28	6.56
600	15.34	24.26	24.67	15.45	1.53	0.85	41.56	21.26	6.63
700	15.28	24.22	23.36	14.93	1.52	0.85	40.00	21.21	6.59
800	15.22	24.17	22.30	14.44	1.51	0.85	40.24	21.22	6.64
900	15.15	24.11	21.34	13.95	1.50	0.85	40.64	21.05	6.64
1000	15.07	24.05	20.55	13.48	1.49	0.85	39.40	21.19	6.71
1100	14.99	23.99	19.84	13.05	1.49	0.85	40.19	21.11	6.71
1200	14.90	23.92	19.14	12.64	1.48	0.85	39.47	21.05	6.71
1250	14.86	23.89	18.89	12.45	1.47	0.85	39.79	21.04	6.71
1500	14.62	23.70	17.62	11.57	1.45	0.84	38.51	21.06	6.76
1750	14.38	23.49	16.71	10.88	1.42	0.84	38.73	20.95	6.77
2000	14.11	23.28	15.94	10.32	1.40	0.84	37.83	21.06	6.84
2250	13.84	23.05	15.40	9.89	1.38	0.84	37.24	21.04	6.82
2500	13.57	22.84	15.02	9.57	1.37	0.84	36.60	21.04	6.83
2750	13.31	22.62	14.69	9.31	1.36	0.84	35.88	20.92	6.93
3000	13.05	22.40	14.49	9.15	1.35	0.84	35.46	21.24	7.02
3250	12.79	22.17	14.35	9.07	1.35	0.84	35.35	21.19	6.96
3500	12.54	21.96	14.27	9.02	1.35	0.84	35.09	21.03	7.07
3750	12.29	21.74	14.32	9.03	1.35	0.84	34.41	20.88	7.09
4000	12.06	21.53	14.48	9.04	1.36	0.84	33.93	20.84	7.10
4250	11.83	21.32	14.69	9.08	1.37	0.84	33.44	21.02	7.11
4500	11.59	21.13	15.00	9.19	1.38	0.84	33.11	20.75	7.15
4750	11.36	20.94	15.35	9.31	1.40	0.84	32.53	20.62	7.19
5000	11.13	20.78	15.73	9.37	1.42	0.84	32.00	20.43	7.27
5250	10.88	20.61	16.11	9.44	1.44	0.84	32.09	20.32	7.28
5500	10.64	20.47	16.30	9.52	1.46	0.84	31.51	19.90	7.28
5750	10.38	20.36	16.41	9.58	1.49	0.84	31.58	19.70	7.35
6000	10.12	20.26	16.38	9.61	1.51	0.84	30.96	19.52	7.40
6250	9.85	20.18	16.20	9.60	1.54	0.84	31.00	19.31	7.46
6500	9.57	20.11	15.75	9.50	1.57	0.84	30.58	19.10	7.57
6750	9.28	20.04	15.17	9.38	1.60	0.84	30.61	18.81	7.55
7000	8.98	20.01	14.62	9.26	1.64	0.84	30.28	18.61	7.66

Typical Performance Data

Definitions:

Input Return Loss = -S11 (dB)

Gain(Power Gain) = S21 (dB)

Reverse Isolation = -S12 (dB)

Output Return Loss = -S22 (dB)

TEST CONDITIONS: Vd = 5.00V, Id = 98.81mA @ Temperature = -45°C

FREQ	Gain	Isolation	Input Return Loss	Output Return Loss	Stability		IP-3 Output	1dB Comp. Output	Noise Figure
					K	Measure			
(MHz)	(dB)	(dB)	(dB)	(dB)	K	Measure	(dBm)	(dBm)	(dB)
20	15.57	24.41	38.29	17.04	1.54	0.85	44.19	19.24	5.93
40	15.56	24.41	34.36	16.83	1.54	0.85	46.84	19.97	5.73
60	15.55	24.39	33.57	16.60	1.54	0.85	43.73	20.06	5.77
80	15.54	24.39	31.77	16.42	1.54	0.85	42.12	20.06	5.74
100	15.54	24.40	31.53	16.31	1.54	0.84	44.38	19.97	5.76
200	15.53	24.38	32.09	16.57	1.54	0.85	42.39	20.08	5.72
300	15.50	24.35	29.73	16.26	1.53	0.85	45.40	20.19	5.83
400	15.48	24.31	27.76	16.29	1.53	0.85	47.57	20.15	5.72
500	15.44	24.28	26.56	15.72	1.52	0.85	41.99	20.24	5.68
600	15.39	24.24	24.45	15.43	1.52	0.85	41.36	20.23	5.81
700	15.34	24.19	23.31	14.80	1.51	0.85	42.13	20.19	5.76
800	15.27	24.13	21.89	14.32	1.50	0.85	40.54	20.18	5.79
900	15.20	24.07	21.14	13.78	1.49	0.84	39.66	20.06	5.79
1000	15.13	24.00	20.13	13.45	1.48	0.85	39.11	20.19	5.84
1100	15.05	23.93	19.54	12.99	1.47	0.84	38.60	20.13	5.88
1200	14.97	23.85	18.99	12.66	1.46	0.84	38.26	20.09	5.86
1250	14.93	23.81	18.77	12.48	1.45	0.84	38.42	20.05	5.86
1500	14.70	23.60	17.61	11.60	1.42	0.84	37.23	20.10	5.89
1750	14.45	23.39	16.76	10.86	1.40	0.84	37.11	20.03	5.88
2000	14.19	23.16	16.03	10.32	1.38	0.83	36.42	20.11	5.94
2250	13.92	22.93	15.60	9.85	1.36	0.83	36.05	20.04	5.95
2500	13.66	22.70	15.02	9.62	1.34	0.83	36.58	20.02	5.94
2750	13.38	22.51	14.60	9.28	1.33	0.83	35.16	20.02	6.08
3000	13.09	22.30	14.20	9.02	1.32	0.83	35.09	20.16	6.15
3250	12.85	22.08	13.92	8.95	1.32	0.84	35.49	20.06	6.09
3500	12.62	21.84	14.07	8.90	1.32	0.83	35.14	19.99	6.11
3750	12.40	21.61	14.26	8.86	1.32	0.83	34.64	20.00	6.16
4000	12.19	21.38	14.64	8.81	1.32	0.82	34.06	20.13	6.12
4250	12.00	21.14	15.00	8.94	1.32	0.82	34.72	20.00	6.15
4500	11.80	20.92	15.27	9.14	1.33	0.82	34.06	20.02	6.22
4750	11.60	20.72	15.42	9.35	1.35	0.83	33.36	20.06	6.19
5000	11.39	20.54	16.12	9.33	1.36	0.82	32.99	20.17	6.28
5250	11.16	20.37	16.61	9.36	1.37	0.82	33.13	19.94	6.30
5500	10.94	20.23	17.21	9.31	1.39	0.81	32.37	19.80	6.25
5750	10.67	20.14	16.89	9.24	1.41	0.81	32.30	19.52	6.33
6000	10.39	20.08	16.19	9.10	1.44	0.81	32.09	19.47	6.44
6250	10.12	20.03	15.69	9.00	1.46	0.82	31.93	19.26	6.47
6500	9.82	19.98	15.32	8.75	1.49	0.81	31.93	19.05	6.51
6750	9.53	19.93	14.68	8.64	1.51	0.81	31.54	18.65	6.56
7000	9.27	19.87	14.29	8.57	1.54	0.82	31.46	18.64	6.62

Typical Performance Data

Definitions:

Input Return Loss = -S11 (dB)

Gain(Power Gain) = S21 (dB)

Reverse Isolation = -S12 (dB)

Output Return Loss = -S22 (dB)

TEST CONDITIONS: Vd = 4.75V, Id = 89.87mA @ Temperature = -45°C

FREQ	Gain	Isolation	Input Return Loss	Output Return Loss	Stability		IP-3 Output	1dB Comp. Output	Noise Figure
					K	Measure			
(MHz)	(dB)	(dB)	(dB)	(dB)			(dBm)	(dBm)	(dB)
20	15.55	24.37	36.06	16.89	1.54	0.85	45.42	18.43	5.85
40	15.53	24.36	33.28	16.68	1.54	0.85	42.21	19.13	5.62
60	15.52	24.34	32.34	16.46	1.53	0.84	44.47	19.20	5.68
80	15.51	24.35	30.91	16.28	1.53	0.84	39.75	19.21	5.62
100	15.51	24.35	30.56	16.17	1.53	0.84	40.55	19.12	5.63
200	15.50	24.32	31.17	16.43	1.53	0.85	40.89	19.22	5.60
300	15.47	24.30	29.02	16.12	1.53	0.84	39.25	19.31	5.64
400	15.45	24.26	27.39	16.15	1.52	0.85	40.18	19.27	5.64
500	15.40	24.22	26.24	15.60	1.52	0.85	40.68	19.34	5.65
600	15.36	24.18	24.25	15.31	1.51	0.85	38.95	19.34	5.67
700	15.30	24.13	23.15	14.69	1.50	0.85	38.23	19.29	5.68
800	15.24	24.07	21.71	14.22	1.49	0.85	38.12	19.29	5.68
900	15.17	24.01	20.97	13.68	1.48	0.84	37.32	19.20	5.69
1000	15.09	23.94	19.96	13.35	1.47	0.84	37.81	19.28	5.73
1100	15.01	23.87	19.39	12.89	1.46	0.84	37.70	19.24	5.75
1200	14.93	23.78	18.85	12.57	1.45	0.84	36.91	19.20	5.74
1250	14.89	23.74	18.64	12.39	1.44	0.84	36.58	19.18	5.73
1500	14.66	23.53	17.46	11.52	1.42	0.84	36.25	19.20	5.79
1750	14.41	23.31	16.63	10.79	1.39	0.83	35.89	19.15	5.82
2000	14.14	23.08	15.92	10.25	1.37	0.83	34.83	19.20	5.85
2250	13.87	22.85	15.47	9.79	1.35	0.83	35.44	19.13	5.84
2500	13.61	22.61	14.94	9.57	1.33	0.83	35.14	19.11	5.83
2750	13.33	22.41	14.52	9.23	1.32	0.83	33.79	19.18	5.97
3000	13.04	22.21	14.14	8.98	1.31	0.83	33.99	19.20	6.02
3250	12.79	21.98	13.84	8.91	1.31	0.83	34.52	19.06	5.98
3500	12.56	21.74	14.02	8.87	1.31	0.83	34.11	19.05	6.01
3750	12.33	21.51	14.22	8.83	1.31	0.83	33.36	19.12	6.06
4000	12.13	21.28	14.55	8.79	1.31	0.82	33.27	19.29	6.01
4250	11.93	21.04	14.94	8.92	1.32	0.82	33.52	18.99	6.03
4500	11.73	20.83	15.22	9.13	1.33	0.82	32.88	19.14	6.09
4750	11.53	20.63	15.35	9.34	1.34	0.83	32.42	19.22	6.10
5000	11.32	20.45	16.06	9.32	1.35	0.82	32.15	19.33	6.20
5250	11.09	20.28	16.54	9.35	1.37	0.82	32.15	19.16	6.15
5500	10.87	20.14	17.14	9.31	1.39	0.81	31.39	19.16	6.19
5750	10.60	20.05	16.84	9.23	1.41	0.81	31.37	18.91	6.23
6000	10.32	20.00	16.15	9.09	1.43	0.81	31.06	18.92	6.30
6250	10.04	19.94	15.66	9.00	1.46	0.81	31.02	18.70	6.33
6500	9.75	19.90	15.27	8.76	1.48	0.81	30.93	18.49	6.40
6750	9.46	19.86	14.65	8.64	1.51	0.81	30.92	18.14	6.44
7000	9.19	19.80	14.28	8.58	1.54	0.82	30.56	18.11	6.51

Typical Performance Data

Definitions:

Input Return Loss = -S11 (dB)

Gain(Power Gain) = S21 (dB)

Reverse Isolation = -S12 (dB)

Output Return Loss = -S22 (dB)

TEST CONDITIONS: Vd = 5.25V, Id = 107.88mA @ Temperature = -45°C

FREQ	Gain	Isolation	Input Return Loss	Output Return Loss	Stability		IP-3 Output	1dB Comp. Output	Noise Figure
					K	Measure			
(MHz)	(dB)	(dB)	(dB)	(dB)	K	Measure	(dBm)	(dBm)	(dB)
20	15.60	24.45	40.09	17.16	1.54	0.85	44.52	19.98	6.02
40	15.59	24.45	35.48	16.95	1.54	0.85	39.50	20.71	5.85
60	15.57	24.43	34.52	16.73	1.54	0.85	45.02	20.83	5.89
80	15.57	24.43	32.76	16.55	1.54	0.85	44.29	20.83	5.84
100	15.57	24.43	32.30	16.43	1.54	0.85	43.55	20.73	5.82
200	15.56	24.42	32.76	16.69	1.54	0.85	46.05	20.86	5.82
300	15.53	24.39	30.10	16.37	1.54	0.85	43.74	20.98	5.83
400	15.50	24.36	28.02	16.40	1.53	0.85	50.51	20.92	5.83
500	15.46	24.32	26.77	15.83	1.53	0.85	42.97	21.03	5.85
600	15.42	24.28	24.59	15.53	1.52	0.85	43.58	21.02	5.89
700	15.36	24.24	23.45	14.90	1.51	0.85	40.84	20.98	5.86
800	15.30	24.18	22.00	14.42	1.50	0.85	41.80	20.98	5.90
900	15.23	24.12	21.28	13.87	1.49	0.85	42.84	20.84	5.89
1000	15.16	24.05	20.19	13.54	1.48	0.85	41.81	20.99	5.87
1100	15.08	23.99	19.67	13.07	1.47	0.84	41.22	20.92	5.93
1200	15.01	23.91	19.06	12.74	1.46	0.84	39.38	20.87	5.95
1250	14.97	23.87	18.88	12.56	1.46	0.84	40.37	20.84	5.98
1500	14.73	23.67	17.69	11.67	1.43	0.84	39.30	20.87	5.99
1750	14.49	23.46	16.83	10.92	1.41	0.84	38.26	20.81	6.00
2000	14.23	23.23	16.13	10.38	1.38	0.84	38.51	20.92	6.05
2250	13.96	23.01	15.67	9.90	1.36	0.83	38.20	20.85	6.08
2500	13.70	22.78	15.08	9.67	1.35	0.83	38.01	20.82	6.07
2750	13.43	22.58	14.67	9.33	1.34	0.83	37.01	20.79	6.19
3000	13.14	22.39	14.27	9.06	1.33	0.83	36.34	21.00	6.24
3250	12.89	22.17	13.98	8.98	1.33	0.84	36.55	20.91	6.20
3500	12.67	21.92	14.13	8.93	1.32	0.83	36.59	20.81	6.24
3750	12.44	21.70	14.33	8.88	1.32	0.83	35.55	20.77	6.23
4000	12.24	21.46	14.70	8.84	1.32	0.82	35.18	20.88	6.23
4250	12.05	21.23	15.06	8.96	1.33	0.82	35.37	20.83	6.26
4500	11.85	21.01	15.31	9.16	1.34	0.82	34.87	20.77	6.28
4750	11.65	20.81	15.49	9.37	1.35	0.83	34.28	20.74	6.33
5000	11.44	20.62	16.18	9.34	1.36	0.82	33.67	20.85	6.37
5250	11.21	20.46	16.66	9.37	1.38	0.82	33.63	20.61	6.39
5500	11.00	20.31	17.26	9.33	1.39	0.81	33.07	20.37	6.40
5750	10.73	20.22	16.95	9.26	1.42	0.81	32.90	20.06	6.47
6000	10.45	20.16	16.26	9.11	1.44	0.81	32.74	20.01	6.52
6250	10.17	20.10	15.74	9.01	1.46	0.82	32.54	19.76	6.56
6500	9.89	20.05	15.35	8.76	1.49	0.81	32.56	19.54	6.62
6750	9.59	20.00	14.74	8.64	1.51	0.81	32.33	19.14	6.69
7000	9.33	19.95	14.32	8.57	1.54	0.82	32.15	19.09	6.75

Typical Performance Data

Definitions:

Input Return Loss = -S11 (dB)

Gain(Power Gain) = S21 (dB)

Reverse Isolation = -S12 (dB)

Output Return Loss = -S22 (dB)

TEST CONDITIONS: Vd = 5.00V, Id = 108.52mA @ Temperature = +85°C

FREQ	Gain	Isolation	Input Return Loss	Output Return Loss	Stability		IP-3 Output	1dB Comp. Output	Noise Figure
					K	Measure			
(MHz)	(dB)	(dB)	(dB)	(dB)	K	Measure	(dBm)	(dBm)	(dB)
20	15.45	24.27	40.38	17.31	1.54	0.85	37.54	19.62	7.21
40	15.45	24.27	40.42	17.45	1.54	0.85	43.49	20.38	7.03
60	15.44	24.25	44.40	17.62	1.54	0.85	49.00	20.50	7.06
80	15.44	24.25	44.53	17.81	1.54	0.85	41.49	20.49	7.03
100	15.44	24.25	43.02	17.96	1.54	0.85	42.48	20.37	7.06
200	15.41	24.25	33.22	17.65	1.54	0.85	44.09	20.51	7.05
300	15.37	24.24	29.48	16.94	1.54	0.85	43.13	20.65	7.11
400	15.33	24.22	27.15	16.48	1.53	0.85	41.47	20.55	7.03
500	15.28	24.19	25.28	15.93	1.53	0.85	40.98	20.65	7.09
600	15.23	24.17	23.83	15.24	1.53	0.85	39.99	20.65	7.09
700	15.17	24.13	22.65	14.63	1.52	0.85	39.06	20.57	7.07
800	15.09	24.08	21.67	14.10	1.51	0.85	38.94	20.58	7.13
900	15.02	24.03	20.83	13.53	1.50	0.85	38.46	20.42	7.12
1000	14.94	23.97	20.07	13.04	1.49	0.85	38.06	20.53	7.15
1100	14.85	23.91	19.44	12.61	1.48	0.84	37.50	20.44	7.19
1200	14.76	23.85	18.77	12.18	1.47	0.84	36.76	20.37	7.21
1250	14.72	23.81	18.49	11.98	1.47	0.84	37.21	20.39	7.24
1500	14.47	23.62	17.24	11.19	1.44	0.84	36.50	20.40	7.27
1750	14.22	23.41	16.30	10.58	1.42	0.84	35.99	20.26	7.30
2000	13.96	23.19	15.53	10.10	1.40	0.84	35.46	20.37	7.35
2250	13.68	22.96	14.94	9.73	1.38	0.84	34.88	20.36	7.38
2500	13.40	22.73	14.57	9.45	1.37	0.84	34.25	20.40	7.36
2750	13.14	22.50	14.27	9.28	1.36	0.84	33.57	20.22	7.49
3000	12.88	22.26	14.08	9.23	1.35	0.84	33.25	20.54	7.54
3250	12.61	22.03	14.00	9.23	1.36	0.84	33.22	20.50	7.55
3500	12.34	21.81	13.93	9.26	1.36	0.85	32.81	20.36	7.57
3750	12.06	21.60	13.99	9.31	1.37	0.85	32.22	20.19	7.64
4000	11.80	21.40	14.12	9.34	1.38	0.85	31.90	20.06	7.67
4250	11.52	21.22	14.28	9.40	1.40	0.85	31.53	20.22	7.70
4500	11.24	21.05	14.58	9.52	1.43	0.85	31.09	19.93	7.74
4750	10.98	20.87	14.99	9.66	1.45	0.86	30.60	19.72	7.78
5000	10.70	20.73	15.20	9.82	1.48	0.86	30.05	19.34	7.87
5250	10.42	20.59	15.38	9.97	1.51	0.86	29.86	19.29	7.89
5500	10.13	20.47	15.67	10.01	1.54	0.86	29.52	18.90	7.92
5750	9.85	20.35	15.46	10.29	1.58	0.87	29.25	18.77	7.94
6000	9.56	20.26	15.47	10.47	1.62	0.88	28.97	18.45	8.00
6250	9.27	20.18	15.53	10.42	1.66	0.87	28.82	18.29	8.07
6500	8.97	20.10	15.17	10.47	1.70	0.88	28.47	18.07	8.16
6750	8.65	20.05	14.73	10.44	1.74	0.88	28.56	17.83	8.20
7000	8.30	20.05	14.13	10.14	1.79	0.88	28.20	17.60	8.32

Typical Performance Data

Definitions:

Input Return Loss = -S11 (dB)

Gain(Power Gain) = S21 (dB)

Reverse Isolation = -S12 (dB)

Output Return Loss = -S22 (dB)

TEST CONDITIONS: Vd = 4.75V, Id = 98.73mA @ Temperature = +85°C

FREQ	Gain	Isolation	Input Return Loss	Output Return Loss	Stability		IP-3 Output	1dB Comp. Output	Noise Figure
					K	Measure			
(MHz)	(dB)	(dB)	(dB)	(dB)	K	Measure	(dBm)	(dBm)	(dB)
20	15.43	24.22	37.77	17.14	1.53	0.85	39.28	18.85	7.10
40	15.42	24.22	37.93	17.27	1.53	0.85	41.69	19.60	6.94
60	15.41	24.19	40.60	17.44	1.53	0.85	45.72	19.71	6.98
80	15.41	24.20	41.36	17.63	1.53	0.85	41.55	19.70	6.92
100	15.41	24.20	41.59	17.77	1.53	0.85	40.47	19.59	6.91
200	15.39	24.20	32.88	17.48	1.53	0.85	40.46	19.71	6.93
300	15.34	24.18	29.24	16.78	1.53	0.85	38.60	19.83	7.01
400	15.30	24.16	26.99	16.33	1.53	0.85	40.00	19.74	6.94
500	15.25	24.14	25.06	15.80	1.53	0.85	39.20	19.84	6.91
600	15.20	24.11	23.66	15.12	1.52	0.85	38.33	19.83	6.99
700	15.14	24.07	22.50	14.52	1.51	0.85	38.35	19.77	6.97
800	15.06	24.02	21.55	14.00	1.51	0.85	37.46	19.77	7.01
900	14.99	23.97	20.75	13.44	1.50	0.85	37.29	19.61	7.00
1000	14.91	23.91	19.96	12.95	1.49	0.84	36.97	19.72	7.01
1100	14.82	23.85	19.31	12.53	1.48	0.84	36.60	19.64	7.08
1200	14.73	23.78	18.65	12.10	1.47	0.84	35.67	19.58	7.11
1250	14.68	23.75	18.38	11.91	1.46	0.84	36.49	19.59	7.09
1500	14.44	23.55	17.17	11.12	1.44	0.84	35.37	19.60	7.13
1750	14.18	23.34	16.20	10.53	1.41	0.84	34.98	19.47	7.18
2000	13.92	23.11	15.47	10.05	1.39	0.84	34.27	19.57	7.24
2250	13.64	22.88	14.88	9.68	1.37	0.84	33.98	19.55	7.23
2500	13.36	22.65	14.50	9.40	1.36	0.84	33.52	19.59	7.24
2750	13.10	22.42	14.23	9.25	1.35	0.84	33.11	19.46	7.37
3000	12.83	22.18	14.06	9.19	1.35	0.84	32.83	19.74	7.42
3250	12.57	21.95	13.96	9.19	1.35	0.84	32.75	19.69	7.40
3500	12.30	21.73	13.89	9.22	1.35	0.85	32.33	19.53	7.48
3750	12.03	21.52	13.96	9.27	1.37	0.85	32.12	19.42	7.53
4000	11.76	21.32	14.10	9.30	1.38	0.85	31.30	19.34	7.51
4250	11.49	21.14	14.28	9.37	1.39	0.85	31.22	19.52	7.56
4500	11.21	20.97	14.57	9.48	1.42	0.85	30.72	19.28	7.59
4750	10.95	20.79	14.97	9.62	1.44	0.85	30.27	19.10	7.67
5000	10.68	20.65	15.20	9.78	1.47	0.86	29.74	18.75	7.71
5250	10.39	20.51	15.40	9.93	1.50	0.86	29.59	18.75	7.69
5500	10.12	20.39	15.69	9.97	1.53	0.86	29.16	18.37	7.73
5750	9.84	20.27	15.50	10.25	1.57	0.87	29.17	18.23	7.81
6000	9.55	20.18	15.49	10.42	1.61	0.87	28.74	18.01	7.85
6250	9.26	20.11	15.56	10.38	1.65	0.87	28.56	17.85	7.94
6500	8.97	20.03	15.24	10.43	1.68	0.88	28.32	17.66	8.02
6750	8.65	19.98	14.77	10.39	1.73	0.88	28.45	17.44	8.01
7000	8.30	19.98	14.18	10.09	1.78	0.88	27.99	17.25	8.17

Typical Performance Data

Definitions:

Input Return Loss = -S11 (dB)

Gain(Power Gain) = S21 (dB)

Reverse Isolation = -S12 (dB)

Output Return Loss = -S22 (dB)

TEST CONDITIONS: Vd = 5.25V, Id = 118.59mA @ Temperature = +85°C

FREQ	Gain	Isolation	Input Return Loss	Output Return Loss	Stability		IP-3 Output	1dB Comp. Output	Noise Figure
					K	Measure			
(MHz)	(dB)	(dB)	(dB)	(dB)	K	Measure	(dBm)	(dBm)	(dB)
20	15.48	24.31	42.76	17.44	1.54	0.85	42.83	20.30	7.34
40	15.47	24.32	43.61	17.59	1.54	0.85	40.92	21.08	7.16
60	15.46	24.29	48.11	17.76	1.54	0.85	41.70	21.22	7.20
80	15.46	24.29	46.21	17.96	1.54	0.85	43.91	21.21	7.17
100	15.46	24.30	43.15	18.11	1.54	0.85	42.87	21.10	7.19
200	15.43	24.29	33.23	17.80	1.54	0.85	45.88	21.24	7.14
300	15.39	24.28	29.64	17.07	1.54	0.85	42.81	21.37	7.18
400	15.35	24.26	27.34	16.60	1.54	0.85	43.24	21.26	7.19
500	15.30	24.24	25.36	16.04	1.53	0.85	43.41	21.38	7.19
600	15.25	24.22	23.94	15.34	1.53	0.85	40.89	21.38	7.23
700	15.19	24.18	22.74	14.72	1.52	0.85	40.69	21.29	7.19
800	15.12	24.13	21.79	14.18	1.52	0.85	39.48	21.30	7.24
900	15.04	24.08	20.94	13.61	1.51	0.85	38.87	21.11	7.26
1000	14.96	24.02	20.19	13.11	1.50	0.85	40.26	21.25	7.29
1100	14.88	23.96	19.51	12.67	1.49	0.85	39.59	21.14	7.33
1200	14.79	23.90	18.85	12.24	1.48	0.84	38.15	21.08	7.35
1250	14.74	23.87	18.54	12.04	1.47	0.84	38.98	21.10	7.34
1500	14.50	23.68	17.33	11.24	1.45	0.84	37.77	21.10	7.40
1750	14.25	23.47	16.35	10.63	1.42	0.84	36.78	20.95	7.41
2000	13.98	23.25	15.58	10.14	1.40	0.84	36.57	21.07	7.46
2250	13.71	23.02	15.00	9.77	1.39	0.84	36.27	21.07	7.50
2500	13.43	22.79	14.60	9.49	1.37	0.84	35.44	21.12	7.48
2750	13.17	22.57	14.29	9.33	1.36	0.84	34.15	20.90	7.62
3000	12.90	22.32	14.11	9.27	1.36	0.84	33.96	21.24	7.68
3250	12.64	22.09	14.00	9.28	1.36	0.85	33.64	21.21	7.65
3500	12.36	21.87	13.91	9.30	1.37	0.85	33.21	21.08	7.73
3750	12.09	21.66	13.98	9.36	1.38	0.85	32.74	20.86	7.79
4000	11.82	21.46	14.10	9.39	1.39	0.85	32.34	20.64	7.83
4250	11.54	21.28	14.28	9.46	1.41	0.86	31.98	20.80	7.82
4500	11.26	21.11	14.57	9.58	1.43	0.86	31.50	20.44	7.88
4750	10.99	20.93	14.95	9.73	1.46	0.86	30.91	20.21	7.92
5000	10.70	20.79	15.17	9.89	1.49	0.86	30.41	19.81	8.02
5250	10.41	20.65	15.35	10.05	1.52	0.87	30.24	19.72	8.03
5500	10.13	20.52	15.61	10.09	1.55	0.87	29.80	19.32	8.06
5750	9.84	20.41	15.42	10.38	1.59	0.87	29.72	19.15	8.09
6000	9.55	20.32	15.40	10.57	1.63	0.88	29.39	18.87	8.18
6250	9.25	20.24	15.45	10.52	1.67	0.88	29.27	18.68	8.22
6500	8.94	20.16	15.11	10.58	1.71	0.88	28.85	18.44	8.36
6750	8.62	20.11	14.66	10.55	1.76	0.89	28.96	18.19	8.39
7000	8.26	20.11	14.08	10.24	1.81	0.88	28.51	17.96	8.50

Typical Performance Curves

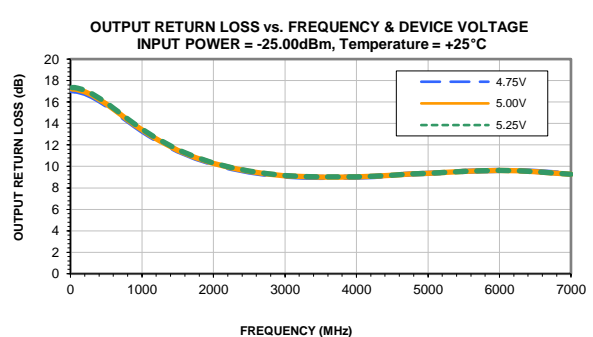
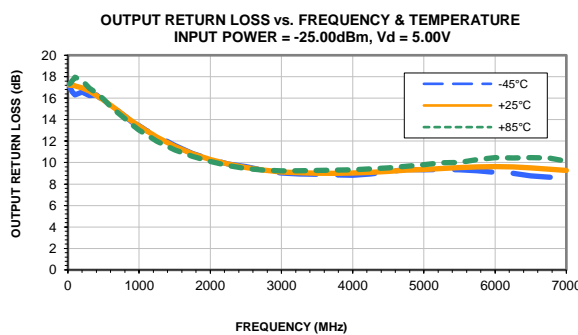
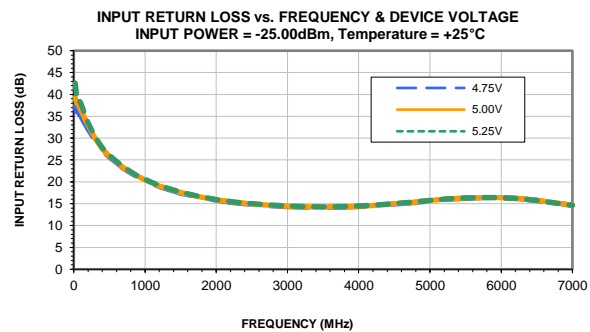
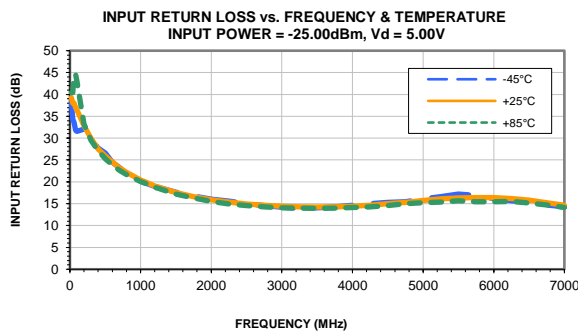
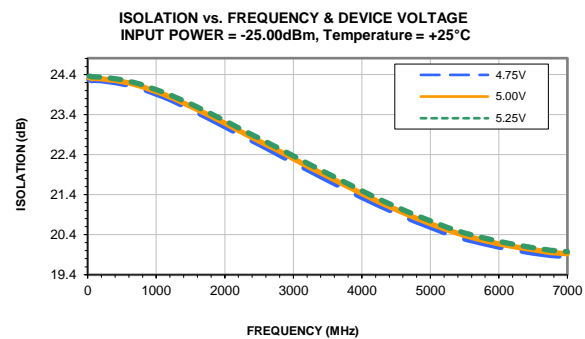
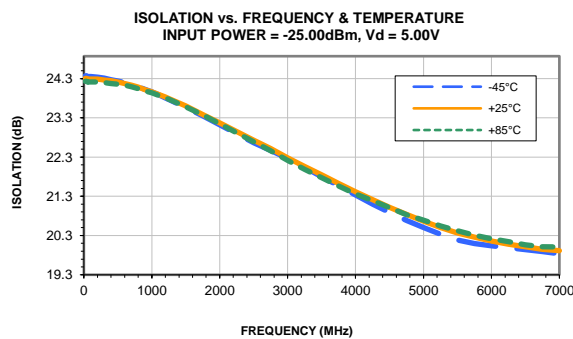
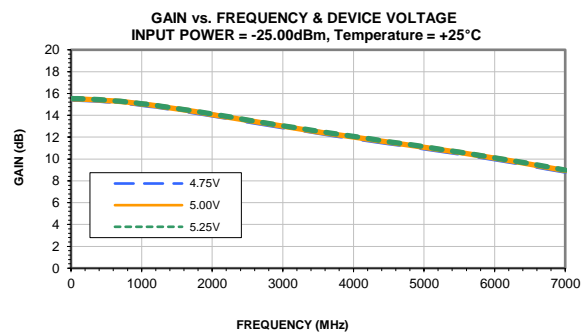
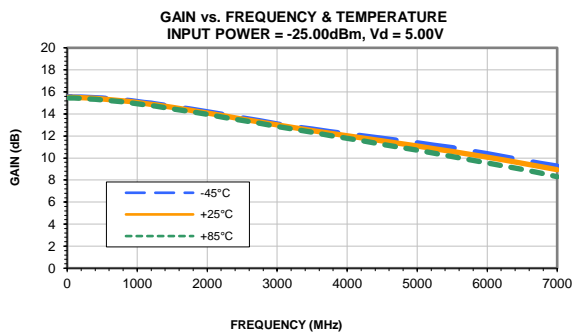

Typical Performance Curves

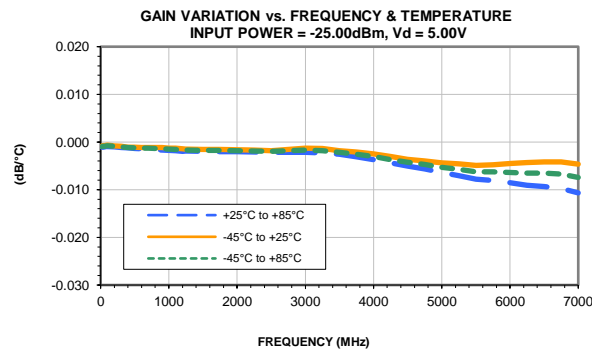
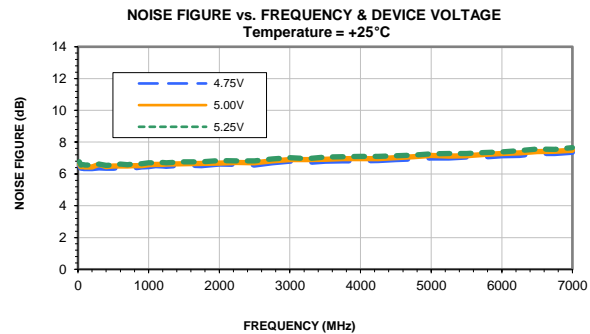
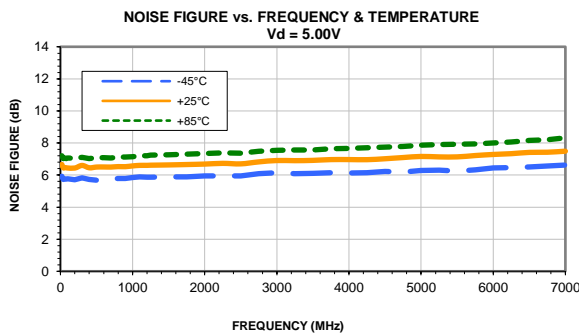
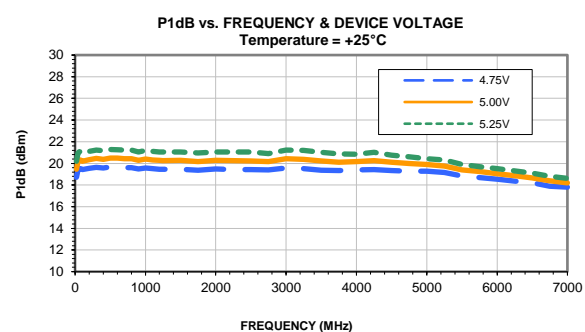
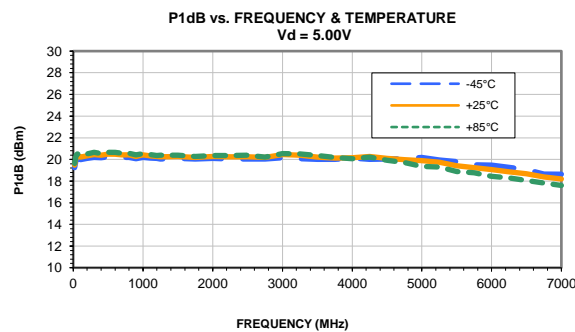
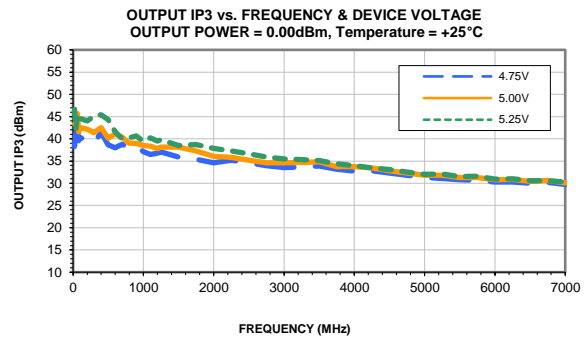
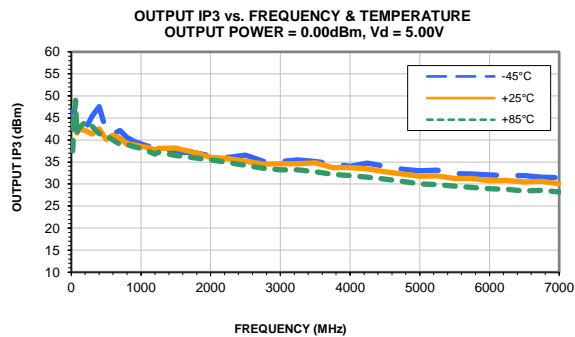

Outline Dimensions

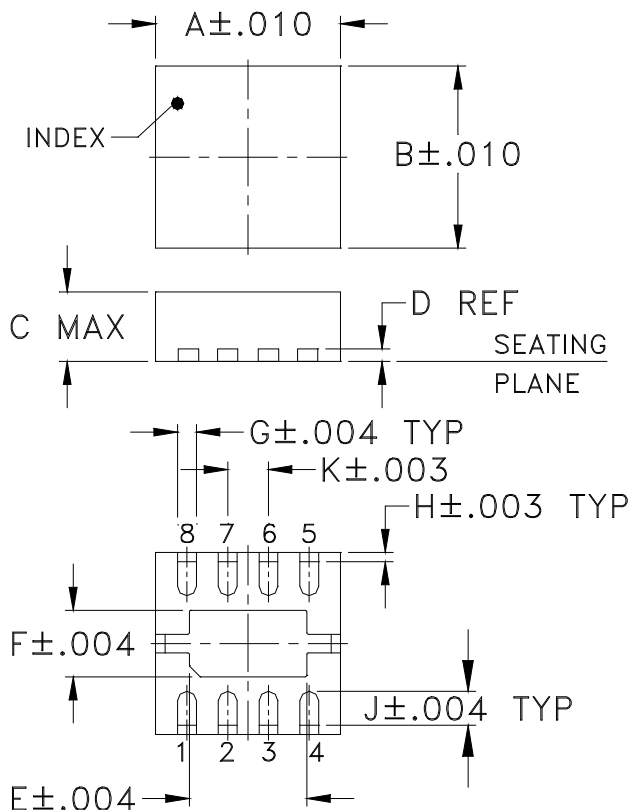

PCB Land Pattern

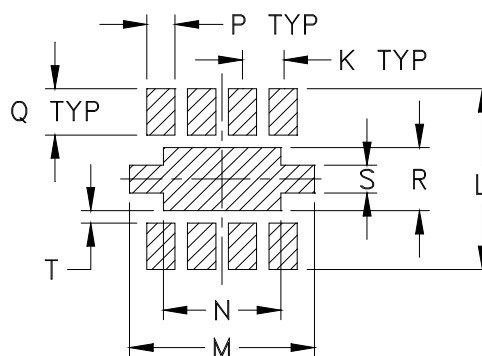

Suggested Layout,
Tolerance to be within $\pm .002$

CASE #	A	B	C	D	E	F	G	H	J	K	L	M	N
DL1721	.118 (3.00)	.118 (3.00)	.045 (1.14)	.008 (0.20)	.075 (1.91)	.043 (1.09)	.012 (0.30)	.006 (0.15)	.022 (0.56)	.026 (0.66)	.117 (2.97)	.118 (3.00)	.075 (1.91)

CASE #	P	Q	R	S	T	WT. GRAM
DL1721	.018 (0.46)	.030 (0.76)	.041 (1.04)	.018 (0.46)	.008 (0.20)	.02

Dimensions are in inches (mm). Tolerances: 3Pl. $\pm .004$, unless otherwise specified.

Notes:

1. Case material: LTCC.
2. Termination finish: Nickel-Palladium-Gold plating.



P.O. Box 350166, Brooklyn, New York 11235-0003 (718) 934-4500 Fax (718) 332-4661 For detailed performance specs & shopping online see Mini-Circuits web site



The Design Engineers Search Engine Provides ACTUAL Data Instantly From MINI-CIRCUITS At: www.minicircuits.com

RF/IF MICROWAVE COMPONENTS

Tape & Reel Packaging TR-F66-1

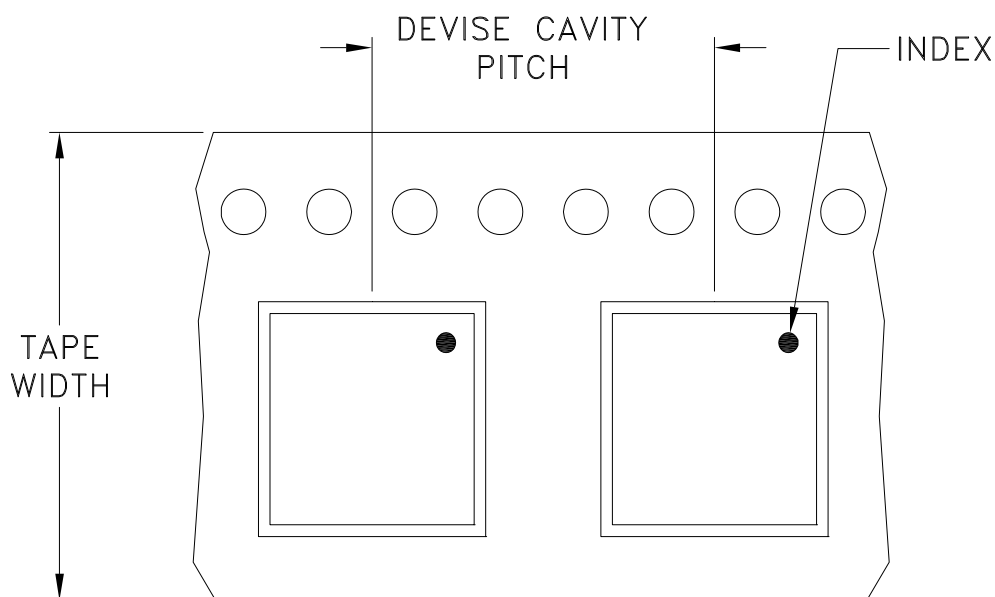

Tape Width, mm	Device Cavity Pitch, mm	Reel Size, inches	Devices per Reel see note	
8	4	7	Small quantity standard	20
				50
				100
				200
				500
		7	Standard	1000, 2000

Note: Please consult individual model data sheet to determine device per reel availability.

Mini-Circuits carrier tape materials provide protection from ESD (Electro-Static Discharge) during handling and transportation. Tapes are static dissipative and comply with industry standards EIA-481/EIA-541.

Go to: www.minicircuits.com/pages/pdfs/tape.pdf



INTERNET <http://www.minicircuits.com>

P.O. Box 350166, Brooklyn, New York 11235-0003 (718) 934-4500 Fax (718) 332-4661

Distribution Centers NORTH AMERICA 800-654-7949 • 417-335-5935 • Fax 417-335-5945 • EUROPE 44-1252-832600 • Fax 44-1252-837010

Mini-Circuits ISO 9001 & ISO 14001 Certified

THIRD ANGLE PROJECTION

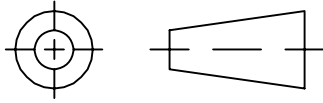

REVISIONS

REV	ECN No.	DESCRIPTION	DATE	DR	AUTH
OR	M136376	NEW RELEASE	06/12/12	PW	DJ

**SUGGESTED MOUNTING CONFIGURATION FOR
DL1721 CASE STYLE, "08AM09" PIN CONNECTION**

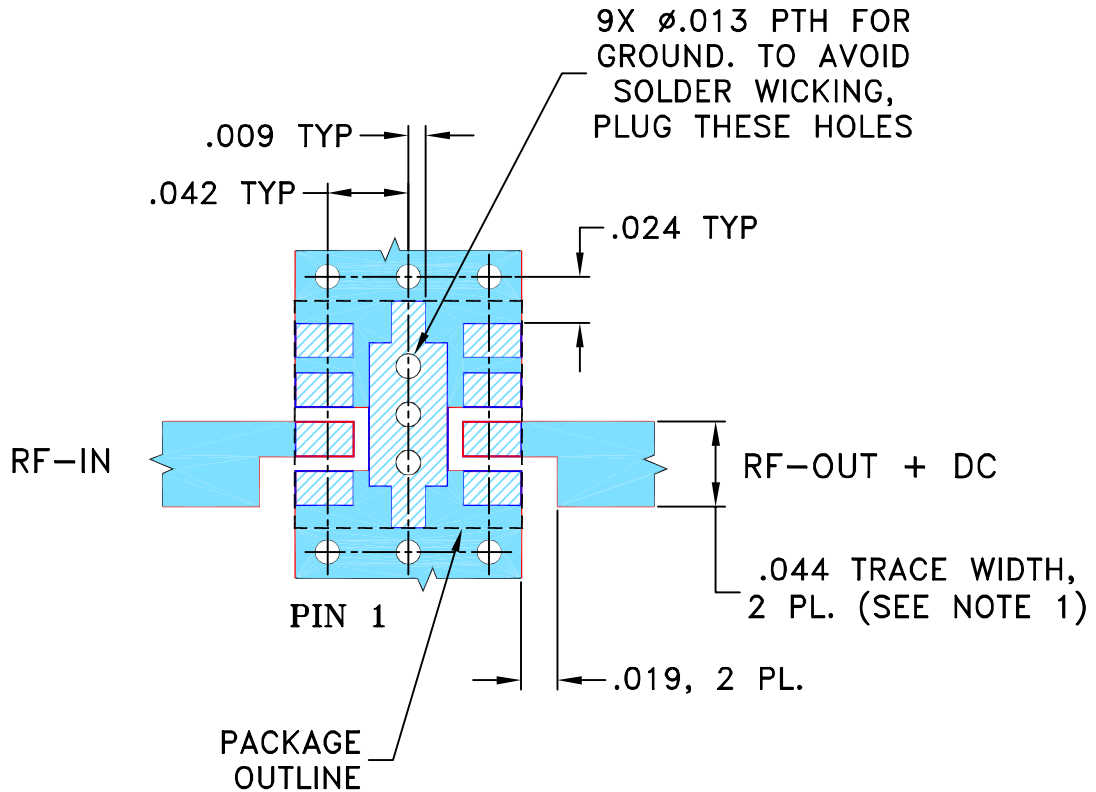

NOTES:

1. TRACE WIDTH IS SHOWN FOR ROGERS R04350B WITH DIELECTRIC THICKNESS .020" ± .0015"; COPPER: 1/2 OZ. EACH SIDE. FOR OTHER MATERIALS TRACE WIDTH AND GAP MAY NEED TO BE MODIFIED.
2. BOTTOM SIDE OF THE PCB IS CONTINUOUS GROUND PLANE.



DENOTES PCB COPPER LAYOUT WITH SMOBC (SOLDER MASK OVER BARE COPPER)



DENOTES COPPER LAND PATTERN FREE OF SOLDER MASK

UNLESS OTHERWISE SPECIFIED

DIMENSIONS ARE IN INCHES
TOLERANCES ON:
2 PL DECIMALS ±
3 PL DECIMALS ± .005
ANGLES ± 1°
FRACTIONS ±

	INITIALS	DATE
DRAWN	PW	05/18/12
CHECKED	IL	06/05/12
APPROVED	DJ	06/12/12



Mini-Circuits®

13 Neptune Avenue
Brooklyn NY 11235

PL, 08AM09, DL1721, CMA TB-656+

THIS DOCUMENT AND ITS CONTENTS ARE THE PROPERTY OF MINI-CIRCUITS. EXCEPT FOR USE EXPRESSLY GRANTED, IN WRITING, TO ITS VENDORS, VENDEE AND THE UNITED STATES GOVERNMENT, MINI-CIRCUITS RESERVES ALL PROPRIETARY DESIGN, USE, MANUFACTURING AND REPRODUCTION RIGHTS THERETO. THESE CONTENTS SHALL NOT BE USED, DUPLICATED OR DISCLOSED TO ANY OUTSIDE PARTY, IN WHOLE OR IN PART, WITHOUT WRITTEN PERMISSION OF MINI-CIRCUITS.

SIZE	CODE IDENT	DRAWING NO:	REV:
A	15542	98-PL-366	OR
FILE:	98PL366	SCALE:	10:1
SHEET:	1	OF	1

ASHEETA1.DWG REV:A DATE:01/12/95

Evaluation Board and Circuit

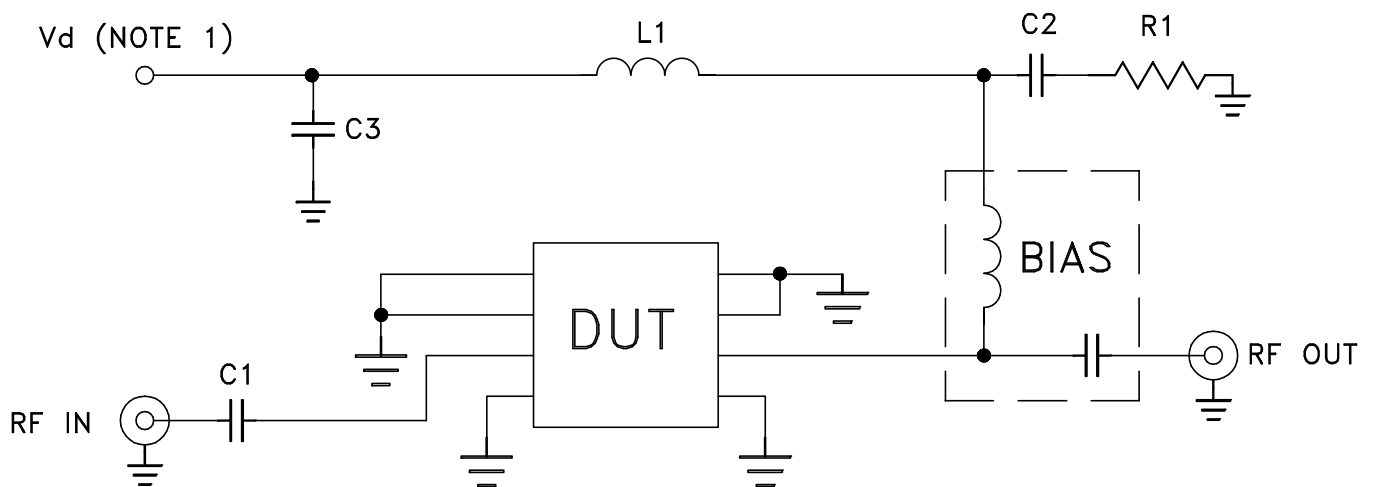
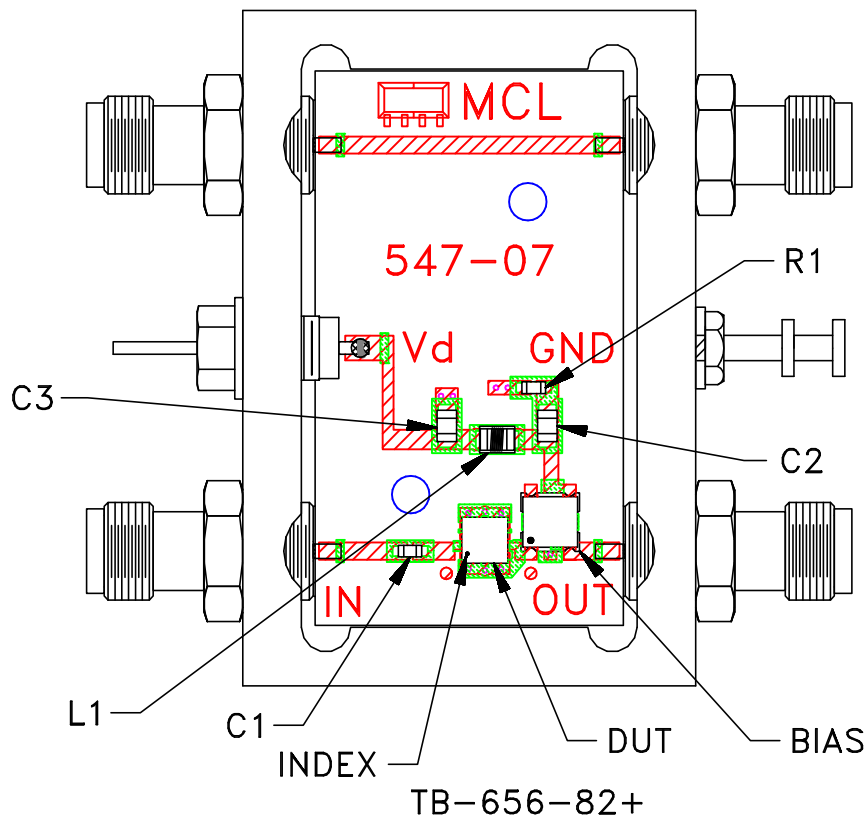

COMPONENT	DESCRIPTION
DUT	CMA-82+
C1	.01 uF
C2,C3	.1 uF
L1	15 nH
R1	11.5 Ohm
BIAS TEE	Mini-Circuits TCBT-14+

Schematic Diagram

NOTES:

1. Vd voltage: +5V.
2. SMA Female connectors.
3. PCB material: Rogers R04350 or equivalent, dielectric constant=3.5, dielectric thickness=.020 inch.

 **Mini-Circuits®**



All Mini-Circuits products are manufactured under exacting quality assurance and control standards, and are capable of meeting published specifications after being subjected to any or all of the following physical and environmental test.

Specification	Test/Inspection Condition	Reference/Spec
Operating Temperature	-55° to 105°C	Individual Model Data Sheet
Storage Temperature	-65° to 125° C	Individual Model Data Sheet
Thermal Shock (device level)	-55° to 125°C, 100 cycles	MIL-STD-202, Method 107
Thermal Shock (board level)	-55° to 125°C, 1000 cycles	MIL-STD-202, Method 107
Constant Acceleration	Y1 plane only, 30 Kg	MIL-STD-883, Method 2001, Cond. E
Vibration	10-2000MHz sine, 20g, 3 axis	MIL-STD-202, Method 204, Cond. D
Mechanical Shock	Y1 plane, 5 pulses, .5ms, 1.5 Kg	MIL-STD-202, Method 213, Cond. A
PIND	20G's @130 Hz	MIL-STD-750, Method 2052.2
Resistance to Soldering Heat	3X Reflow, Peak Temperature 260°C, electrical End points	JESD22-B102
Resistance to Solvent	15 pieces, 5 pieces each solvent, marking permanency	MIL-STD-202, Method 215
Moisture Sensitivity Level	Hermetic device, MSL-1 by construction	JESD22-A113, MSL1/260
Hermeticity	Fine Leak, Gross Leak	MIL-STD-202, Method 112, Cond. C&D



All Mini-Circuits products are manufactured under exacting quality assurance and control standards, and are capable of meeting published specifications after being subjected to any or all of the following physical and environmental test.

Specification	Test/Inspection Condition	Reference/Spec
Autoclave	15 psig, 100% RH, 121°C, 96 hours	JEDEC-STD-22-B, Method A102