

Digital Step Attenuator

75Ω DC-2000 MHz

31.5 dB, 0.5 dB Step

6 Bit, Parallel Control Interface, Single Positive Supply Voltage, +3V

Product Features

- Single positive supply voltage, +3V
- Immune to latch up
- Excellent accuracy, 0.1 dB Typ
- Parallel control interface
- Low Insertion Loss
- High IP3, +52 dBm Typ
- Very low DC power consumption
- Excellent return loss, 20 dB Typ
- Small size 4.0 x 4.0 mm

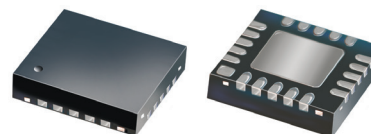

DAT-31575-PP+

CASE STYLE: DG983-1

Typical Applications

- Base Station Infrastructure
- Portable Wireless
- CATV & DBS
- MMDS & Wireless LAN
- Wireless Local Loop
- UNII & Hiper LAN
- Power amplifier distortion canceling loops

+RoHS Compliant

The +Suffix identifies RoHS Compliance. See our web site for RoHS Compliance methodologies and qualifications

This model will be replaced in the future with a improved design. The new model will be [DAT-31575A-PP+](#). It will have similar performance, the same case style and footprint.

General Description

The DAT-31575-PP+ is a 75Ω RF digital step attenuator that offers an attenuation range up to 31.5 dB in 0.5 dB steps. The control is a 6-bit parallel interface, operating on a single +3 volt supply. The DAT-31575-PP+ is produced using a unique CMOS process on silicon, offering the performance of GaAs, with the advantages of conventional CMOS devices.

Simplified Schematic

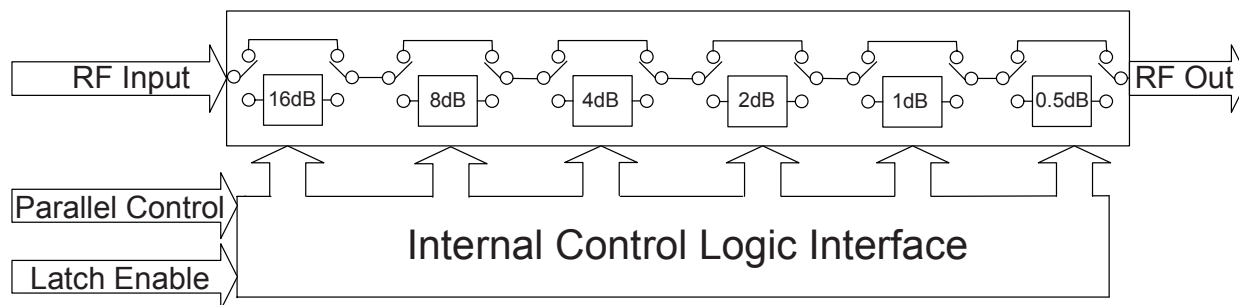

RF Electrical Specifications, DC-2000 MHz, $T_{AMB}=25^{\circ}\text{C}$, $V_{DD}=+3\text{V}$

Parameter	Freq. Range (GHz)	Min.	Typ.	Max.	Units
Accuracy @ 0.5 dB Attenuation Setting	DC-1.2	—	0.03	0.17	dB
	1.2-2.0	—	0.05	0.18	dB
Accuracy @ 1 dB Attenuation Setting	DC-1.2	—	0.03	0.24	dB
	1.2-2.0	—	0.1	0.25	dB
Accuracy @ 2 dB Attenuation Setting	DC-1.2	—	0.07	0.28	dB
	1.2-2.0	—	0.15	0.3	dB
Accuracy @ 4 dB Attenuation Setting	DC-1.2	—	0.05	0.36	dB
	1.2-2.0	—	0.15	0.4	dB
Accuracy @ 8 dB Attenuation Setting	DC-1.2	—	0.1	0.52	dB
	1.2-2.0	—	0.24	0.6	dB
Accuracy @ 16 dB Attenuation Setting	DC-1.2	—	0.23	0.84	dB
	1.2-2.0	—	0.8	1.0	dB
Insertion Loss ^(note 1) @ all attenuator set to 0dB	DC-1.2	—	1.2	1.8	dB
	1.2-2.0	—	1.6	2.1	dB
Input IP3 ^(note 2) (at Min. and Max. Attenuation)	DC-2.0	—	+52	—	dBm
Input Power @ 0.2dB Compression ^(note 2) (at Min. and Max. Attenuation)	DC-2.0	—	+24	—	dBm
VSWR	DC-1.2	—	1.6	2.0	—
	1.2-2.0	—	1.7	2.0	—

DC Electrical Specifications

Parameter	Min.	Typ.	Max.	Units
V_{DD} , Supply Voltage	2.7	3	3.3	V
I_{DD} , Supply Current, quiescent ^(note 3)	—	—	100	μA
Control Input Low	—	—	$0.3 \times V_{DD}$	V
Control Input High	$0.7 \times V_{DD}$	—	—	V
Control Current	—	—	1	μA

Notes:

1. Loss values are de-embedded from test board Loss (test board's Insertion Loss: 0.10dB @100MHz, 0.40dB @1200MHz, 0.55dB @2000MHz, 0.75dB @4000MHz).
2. Input IP3 and 1dB compression degrades below 1 MHz.
3. During turn-on and transition between attenuation states, device may draw up to 2mA.

Switching Specifications

Parameter	Min.	Typ.	Max.	Units
Switching Speed, 50% Control to 0.5dB of Attenuation Value	—	1.0	—	μSec
Switching Control Frequency	—	—	25	KHz

Absolute Maximum Ratings

Parameter	Ratings
Operating Temperature	-40°C to 85°C
Storage Temperature	-55°C to 100°C
V_{DD}	-0.3V Min., 4V Max.
Voltage on any input	-0.3V Min., $V_{DD}+0.3\text{V}$ Max.
ESD, HBM	500V
ESD, MM	100V
Input Power	+24dBm

Permanent damage may occur if any of these limits are exceeded.

Pin Description

Function	Pin Number	Description
C16	1	Control for Attenuation bit, 16dB (Note 3)
RF in	2	RF in port (Note 1)
N/C	3	Not connected (Note 4)
GND	4	Ground connection
LE	5	Latch Enable Input (Note 2)
V _{DD}	6	Power Supply
PUP1	7	Power-up selection bit
PUP2	8	Power-up selection bit
V _{DD}	9	Power Supply
GND	10	Ground connection
GND	11	Ground connection
GND	12	Ground connection (Note 6)
GND	13	Ground connection
RF out	14	RF out port (Note 1)
C8	15	Control for attenuation bit, 8 dB
C4	16	Control for attenuation bit, 4 dB
C2	17	Control for attenuation bit, 2 dB
GND	18	Ground Connection
C1	19	Control for attenuation bit, 1 dB
C0.5	20	Control for attenuation bit, 0.5 dB
GND	Paddle	Paddle ground (Note 5)

Pin Configuration (Top View)

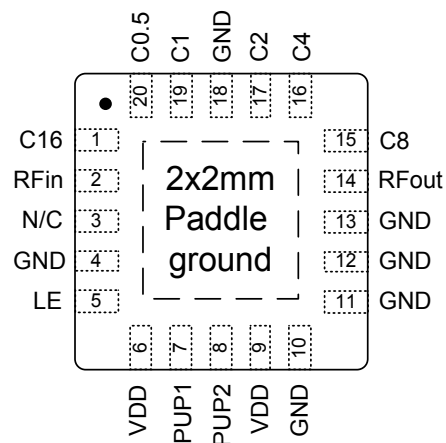

Notes:

- Both RF ports must be held at 0VDC or DC blocked with an external series capacitor.
- Latch Enable (LE) has an internal 100KΩ resistor to V_{DD}.
- Place a 10KΩ resistor in series, as close to pin as possible to avoid freq. resonance.
- Place a shunt 10KΩ resistor to GND.
- The exposed solder pad on the bottom of the package (See Pin configuration) must be grounded for proper device operation.
- Ground must be less than 80 mil (0.08") from Pin 12 for proper device operation.

NON-CATALOG

Digital Step Attenuator

DAT-31575-PP+

Typical Performance Curves

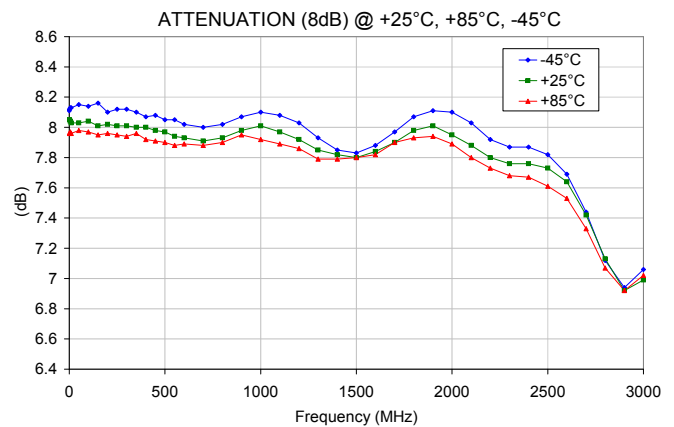
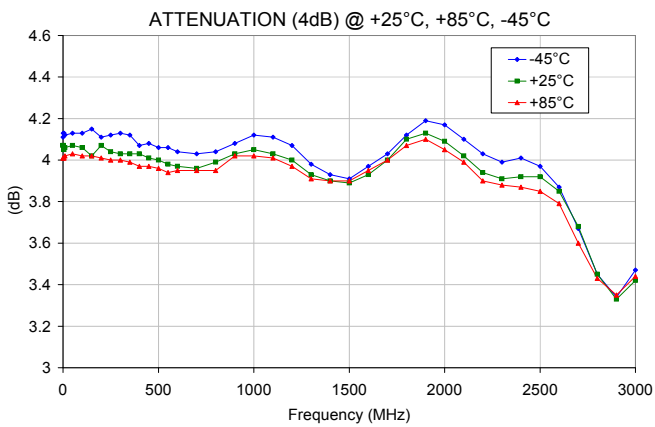
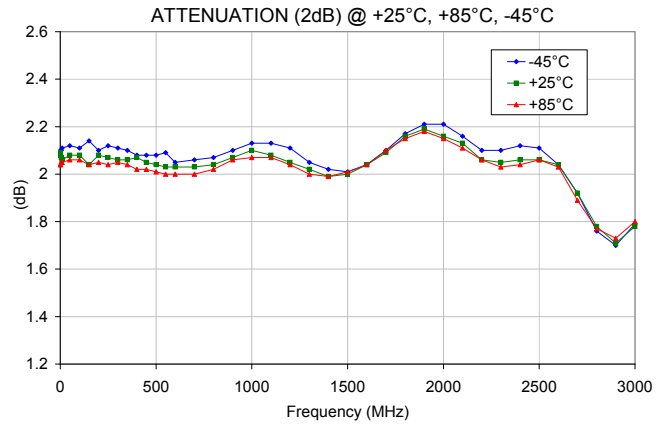
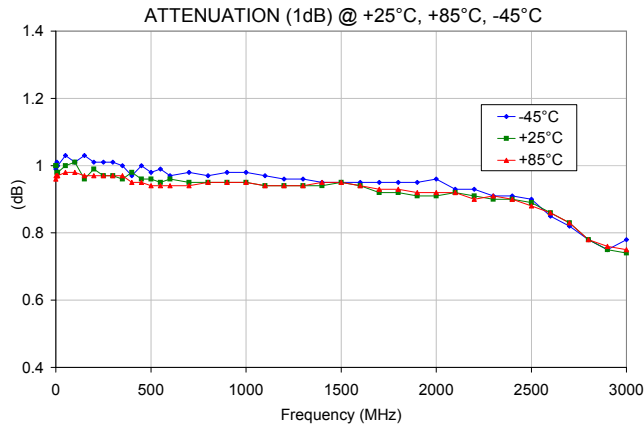
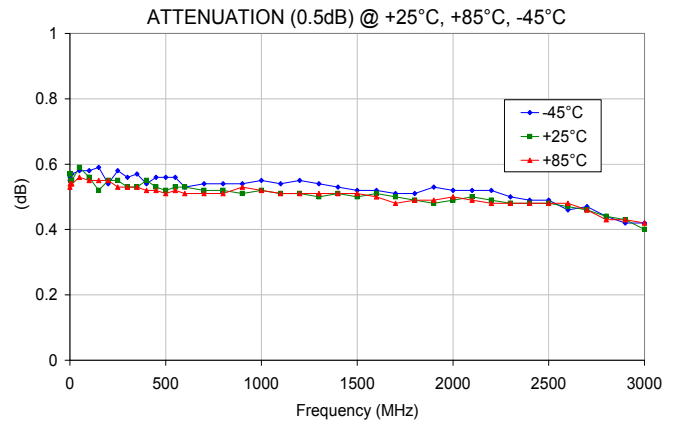
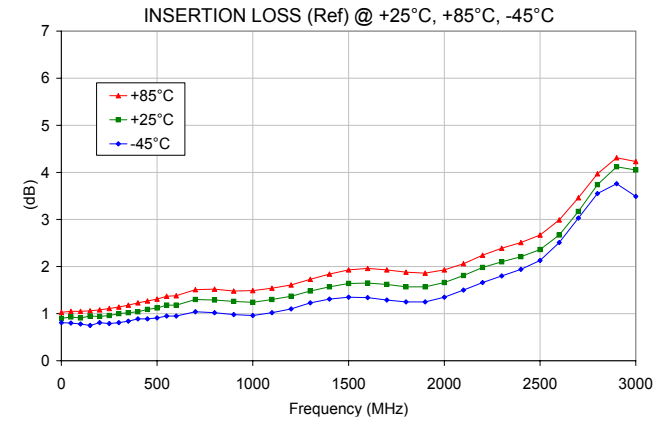

Typical Performance Curves

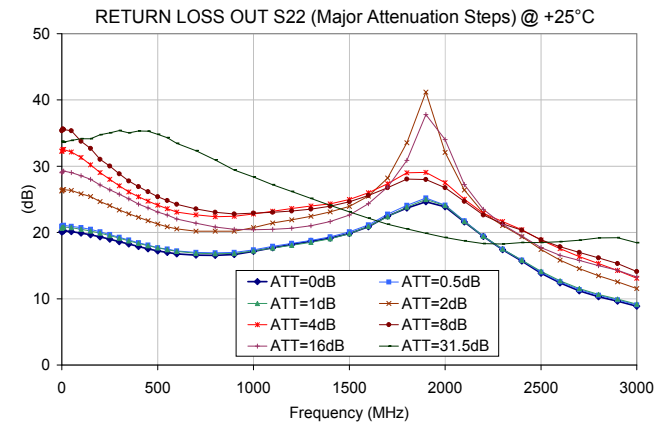
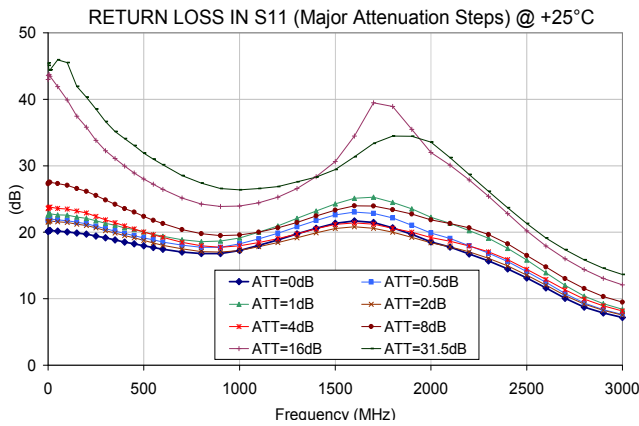
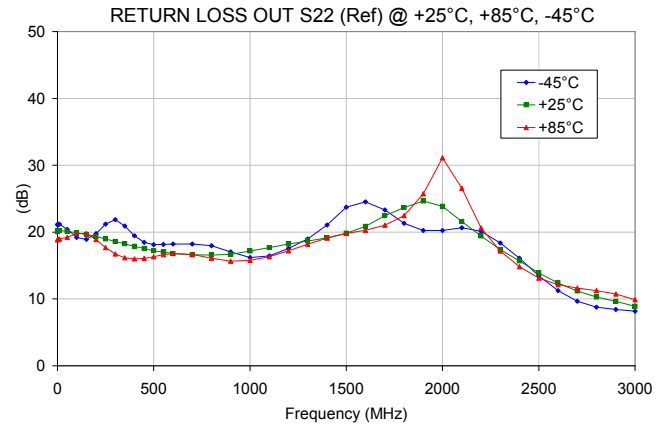
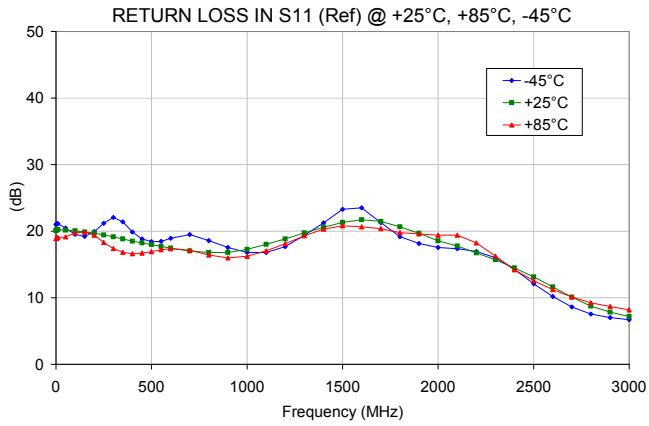
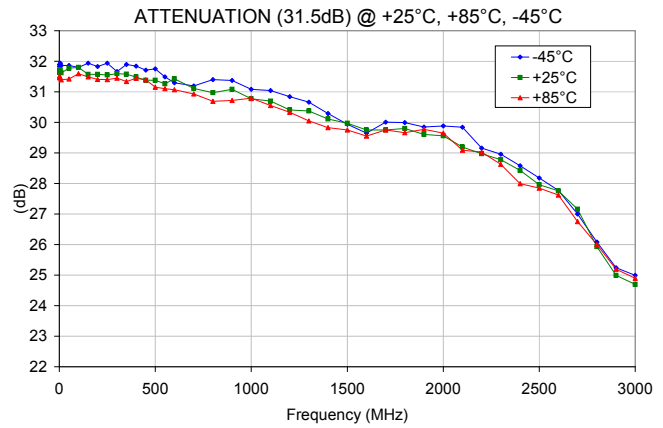
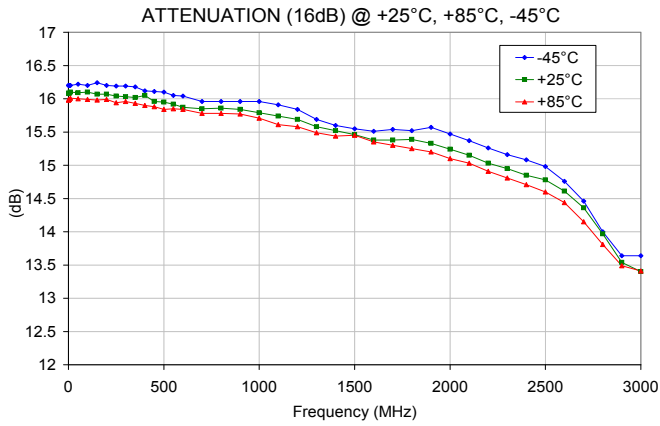

NON-CATALOG

Digital Step Attenuator

DAT-31575-PP+

Typical Performance Curves

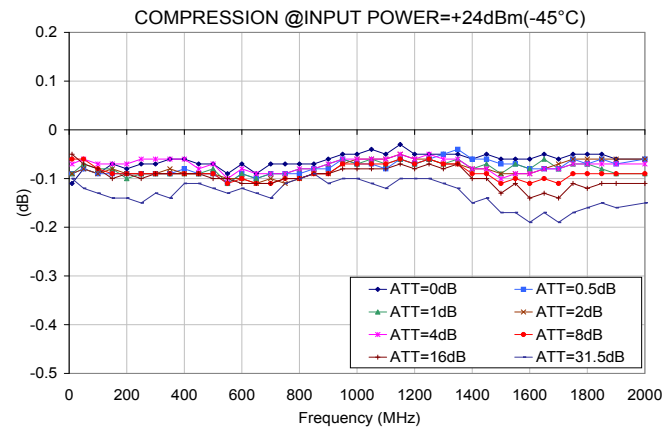
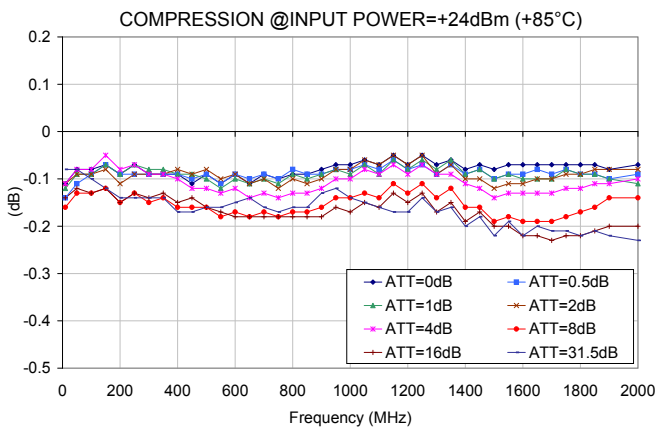
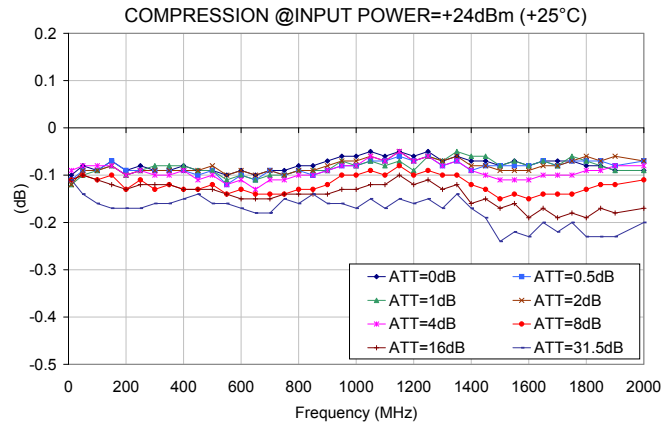
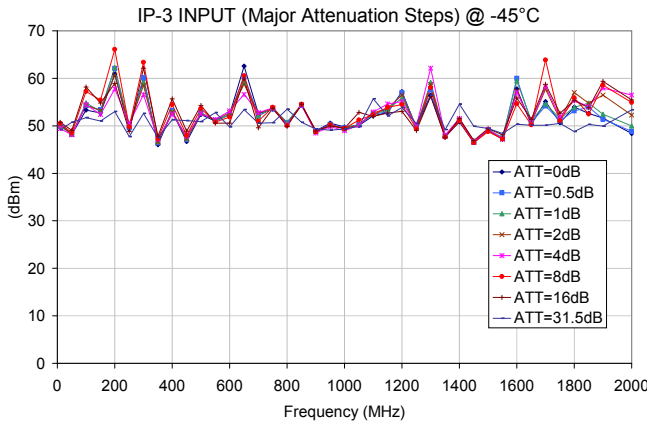
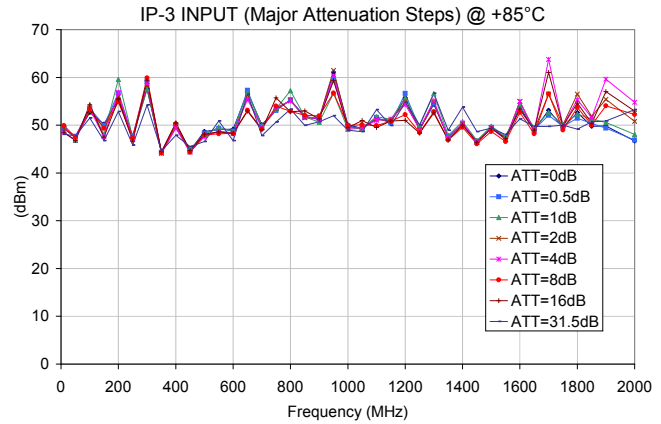
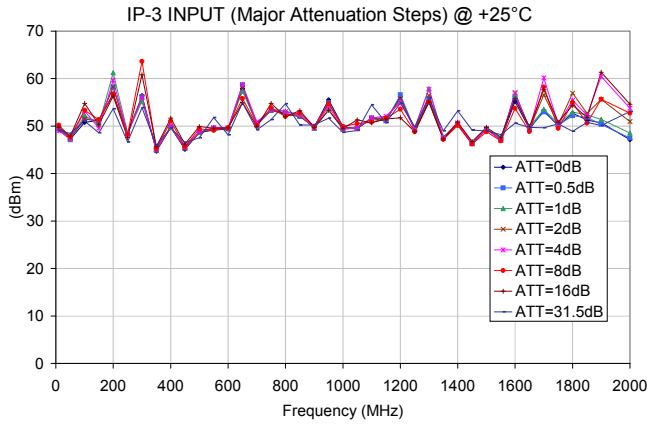

NON-CATALOG

Digital Step Attenuator

DAT-31575-PP+

Outline Drawing (DG983-1)

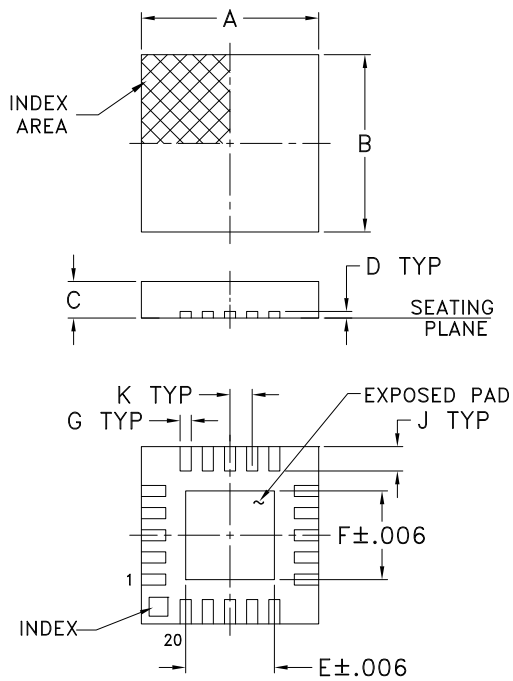

PCB Land Pattern

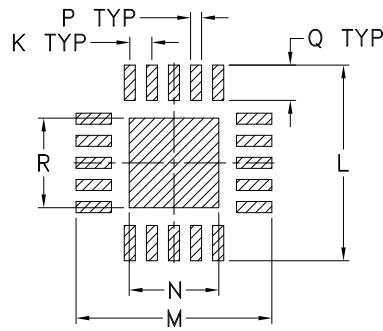

Suggested Layout,
Tolerance to be within $\pm .002$

Device Marking

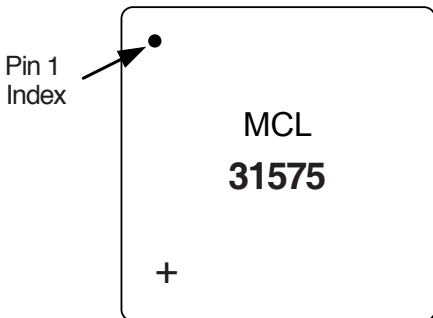

Outline Dimensions (inch/mm)

A	B	C	D	E	F	G	H	J	K	L	M	N	P	Q	R	WT. GRAMS
.157	.157	.035	.008	.081	.081	.010	—	.022	.020	.177	.177	.081	.010	.032	.081	.04
4.00	4.00	0.90	0.20	2.06	2.06	0.25	—	0.56	0.50	4.50	4.50	2.06	0.25	0.81	2.06	

Suggested Layout for PCB Design (PL-184)

The suggested Layout shows only the footprint area of the DAT, and the components located near this area (i.e.: R1, R7). For the complete Layout, see photo and schematic diagram on page 11 of 12.

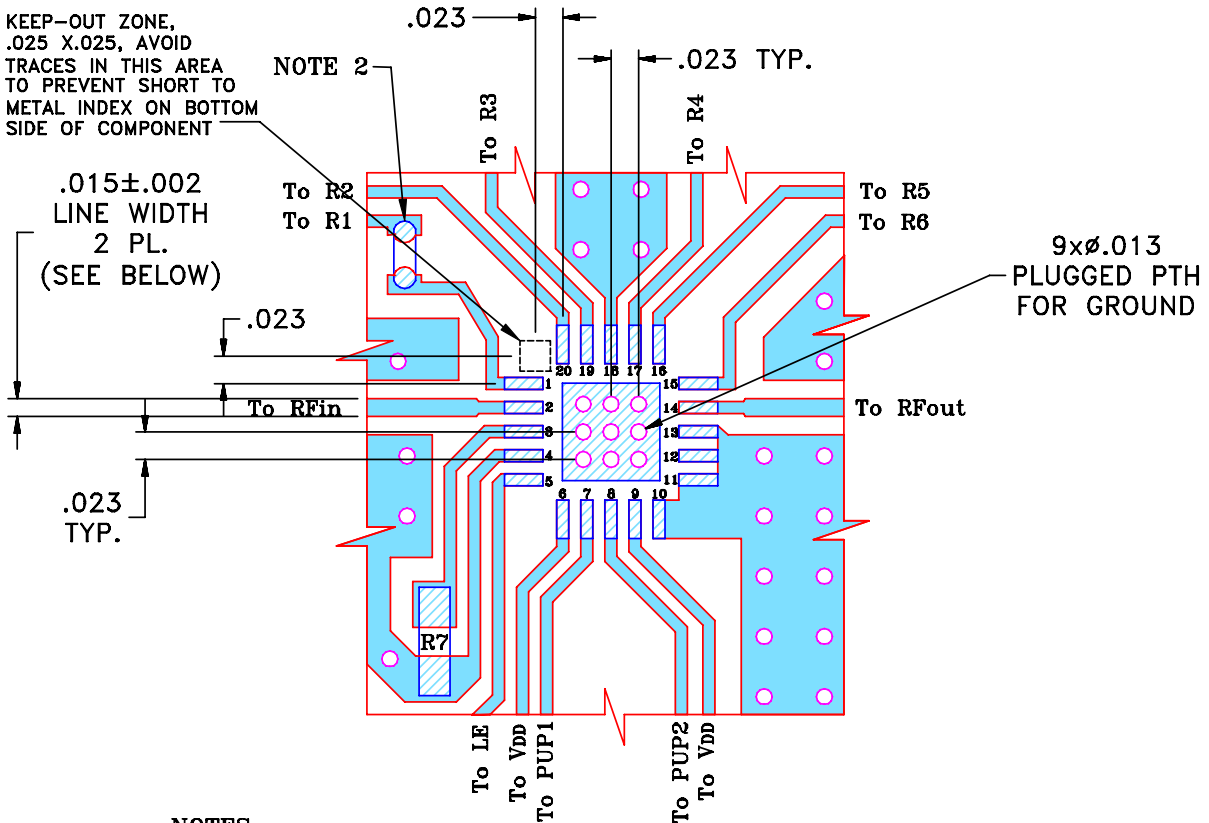

NOTES:

1. TRACE WIDTH IS SHOWN FOR FR4 WITH DIELECTRIC THICKNESS. .025" ± .002". COPPER: 1/2 OZ. EACH SIDE. FOR OTHER MATERIALS TRACE WIDTH MAY NEED TO BE MODIFIED.
2. 0603, 0402 SIZES CHIP FOOT PRINTS SHOWN FOR REFERENCE, VALUES OF RESISTORS WILL VARY BASED ON APPLICATION.
3. BOTTOM SIDE OF THE PCB IS CONTINUOUS GROUND PLANE.

- DENOTES PCB COPPER LAYOUT WITH SMOBC (SOLDER MASK OVER BARE COPPER)
- DENOTES COPPER LAND PATTERN FREE OF SOLDER MASK

Simplified Schematic

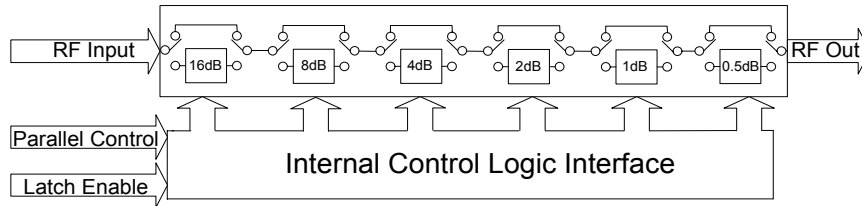

The DAT-31575-PP+ parallel interface consists of 6 control bits that select the desired attenuation state, as shown in Table 1: Truth Table

Attenuation State	C16	C8	C4	C2	C1	C0.5
Reference	0	0	0	0	0	0
0.5 (dB)	0	0	0	0	0	1
1 (dB)	0	0	0	0	1	0
2 (dB)	0	0	0	1	0	0
4 (dB)	0	0	1	0	0	0
8 (dB)	0	1	0	0	0	0
16 (dB)	1	0	0	0	0	0
31.5 (dB)	1	1	1	1	1	1

Note: Not all 64 possible combinations of C0.5 - C16 are shown in table

The parallel interface timing requirements are defined by Figure 1 (Parallel Interface Timing Diagram) and Table 2 (Parallel Interface AC Characteristics), and switching speed.

For latched parallel programming the Latch Enable (LE) should be held LOW while changing attenuation state control values, then pulse LE HIGH to LOW (per Figure 1) to latch new attenuation state into device.

For direct parallel programming, the Latch Enable (LE) line should be pulled HIGH. Changing attenuation state control values will change device state to new attenuation. Direct mode is ideal for manual control of the device (using hardware, switches, or jumpers).

Figure 1: Parallel Interface Timing Diagram

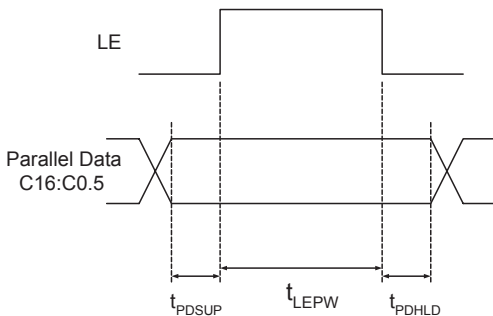

Table 2. Parallel Interface AC Characteristics

Symbol	Parameter	Min.	Max.	Units
t_{LEPW}	LE minimum pulse width	10		ns
t_{PDSUP}	Data set-up time before clock rising edge of LE	10		ns
t_{PDHL}	Data hold time after clock falling edge of LE	10		ns

Power-up Control Settings

The DAT-31575-PP+ always assumes a specifiable attenuation setting on power-up, allowing a known attenuation state to be established before an initial parallel control word is provided.

When the attenuator powers up with LE=0, the control bits are automatically set to one of four possible values. These four values are selected by the two power-up control bits, PUP1 and PUP2, as shown in table 3: (Power-Up Truth Table, Parallel Mode).

Table 3. Power-Up Truth Table, Parallel Mode			
Attenuation State	PUP1	PUP2	LE
Reference	0	0	0
8 (dB)	0	1	0
16 (dB)	1	0	0
31 (dB)	1	1	0
Defined by C0.5-C16 (See Table 1-Truth Table)	X (Note 1)	X (Note 1)	1

Note 1: PUP1 and PUP2 Connection may be 0, 1, GROUND, or not connect, without effect on attenuation state.

Power-Up with LE=1 provides normal parallel operation with C0.5-C16, and PUP1 and PUP2 are not active.

TB-337 Evaluation Board Schematic Diagram

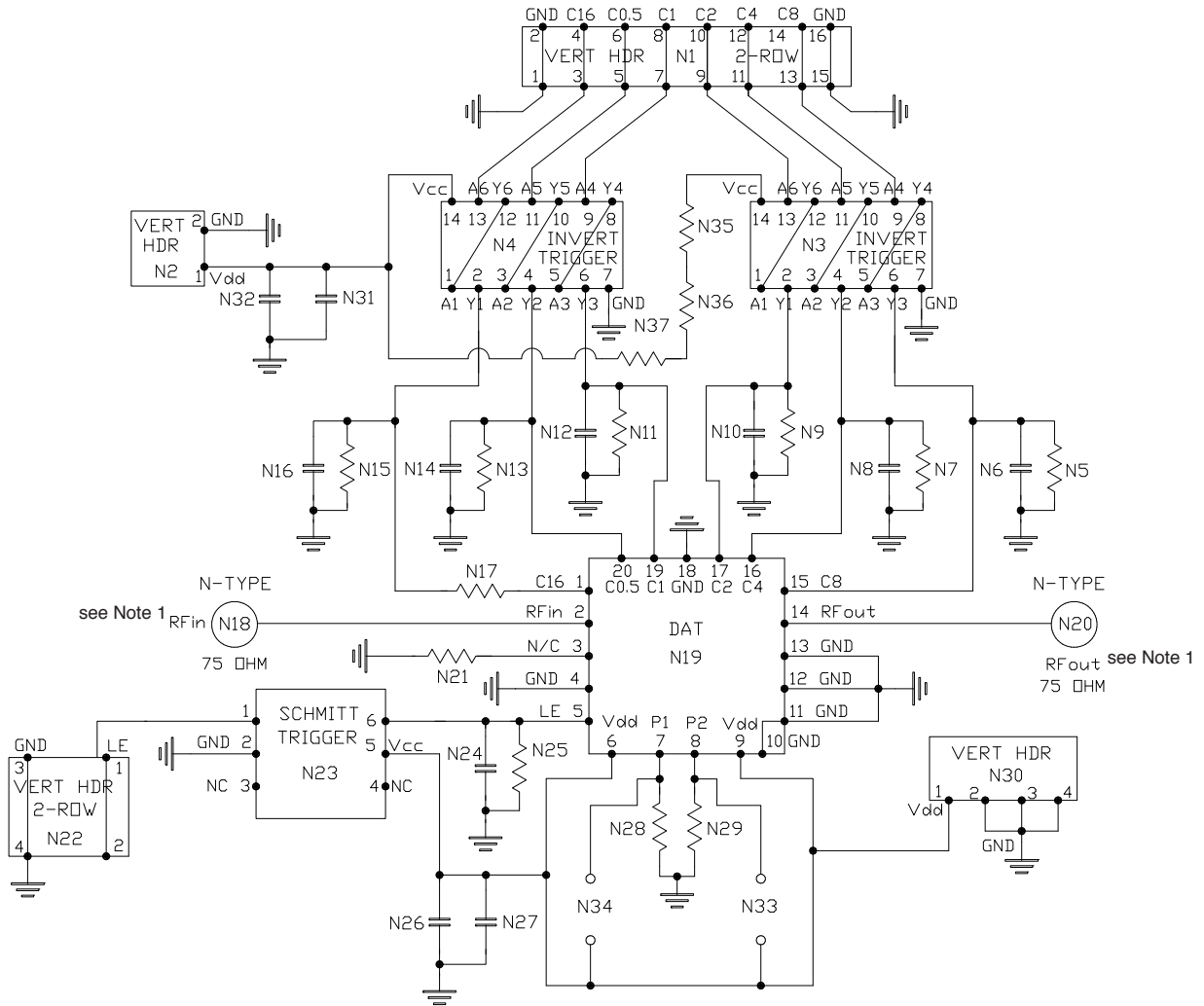

Note 1: Both RF ports must be held at 0VDC or DC blocked with an external series capacitor.

Bill of Materials	
N5, N7, N9, N11, N13, N15, N21 & N25	Resistor 0603 10 KOhm +/- 1%
N28 & N29	Resistor 0603 475 Ohm +/- 1%
N35-N37	Resistor 0603 0 Ohm
N17	Resistor 0402 10 KOhm +/- 1%
N6, N8, N10, N12, N14, N16, N24, N26 & N32	NPO Capacitor 0603 100pF +/- 5%
N27 & N31	Tantalum Capacitor 0805 100nF +/- 10%
N3 & N4	Hex Invert Schmitt Trigger MSL1
N23	Dual Schmitt Trigger Buffer SC-70 MSL1

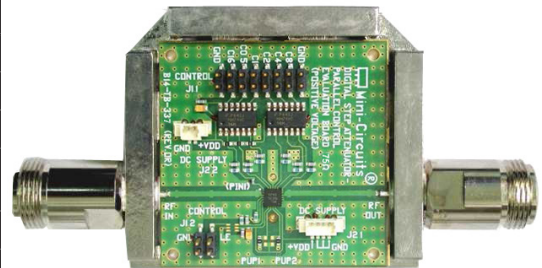

TB-337

Tape and Reel Packaging Information

Table T&R

TR No.	No. of Devices	Reel Size	Tape Width	Pitch	Unit Orientation
F87	Small quantity standards 20, 50, 100, 200	7 inch	12 mm	8 mm	
	3000 (Standard)	13 inch			

Additional Notes

- A. Performance and quality attributes and conditions not expressly stated in this specification document are intended to be excluded and do not form a part of this specification document.
- B. Electrical specifications and performance data contained in this specification document are based on Mini-Circuit's applicable established test performance criteria and measurement instructions.
- C. The parts covered by this specification document are subject to Mini-Circuits standard limited warranty and terms and conditions (collectively, "Standard Terms"); Purchasers of this part are entitled to the rights and benefits contained therein. For a full statement of the Standard Terms and the exclusive rights and remedies thereunder, please visit Mini-Circuits' website at www.minicircuits.com/MCLStore/terms.jsp

Digital Step Attenuator

DAT-31575-PP+

Typical Performance Data

TEST CONDITIONS: INPUT POWER=-10dBm, Vdd=+3V, TEMPERATURE=-45degC

FREQUENCY (MHz)	STEP ATTENUATION* AT TTL CONTROL STATE (dB)							
	000000 THRU LOSS	000001 0.5 dB	000010 1.0 dB	000100 2.0 dB	001000 4.0 dB	010000 8.0 dB	100000 16 dB	111111 31.5 dB
0.5	0.81	0.55	0.99	2.09	4.11	8.11	16.20	31.89
1	0.83	0.56	1.00	2.10	4.13	8.12	16.20	31.82
5	0.84	0.57	1.01	2.10	4.13	8.13	16.20	31.94
10	0.84	0.57	1.00	2.11	4.12	8.13	16.20	31.86
50	0.85	0.58	1.03	2.12	4.13	8.15	16.22	31.86
100	0.86	0.58	1.01	2.11	4.13	8.14	16.20	31.80
150	0.85	0.59	1.03	2.14	4.15	8.16	16.24	31.94
200	0.93	0.54	1.01	2.10	4.11	8.10	16.20	31.83
250	0.92	0.58	1.01	2.12	4.12	8.12	16.19	31.94
300	0.96	0.56	1.01	2.11	4.13	8.12	16.19	31.66
350	1.01	0.57	1.00	2.10	4.12	8.10	16.18	31.90
400	1.08	0.54	0.97	2.08	4.07	8.07	16.12	31.84
450	1.09	0.56	1.00	2.08	4.08	8.08	16.11	31.71
500	1.13	0.56	0.98	2.08	4.06	8.05	16.10	31.75
550	1.18	0.56	0.99	2.09	4.06	8.05	16.05	31.49
600	1.20	0.53	0.97	2.05	4.04	8.02	16.04	31.30
700	1.30	0.54	0.98	2.06	4.03	8.00	15.96	31.19
800	1.31	0.54	0.97	2.07	4.04	8.02	15.96	31.40
900	1.29	0.54	0.98	2.10	4.08	8.07	15.96	31.37
1000	1.29	0.55	0.98	2.13	4.12	8.10	15.96	31.08
1100	1.37	0.54	0.97	2.13	4.11	8.08	15.91	31.04
1200	1.48	0.55	0.96	2.11	4.07	8.03	15.84	30.84
1300	1.63	0.54	0.96	2.05	3.98	7.93	15.69	30.66
1400	1.74	0.53	0.95	2.02	3.93	7.85	15.60	30.29
1500	1.81	0.52	0.95	2.01	3.91	7.83	15.55	29.94
1600	1.82	0.52	0.95	2.04	3.97	7.88	15.51	29.65
1700	1.81	0.51	0.95	2.10	4.03	7.97	15.54	30.01
1800	1.78	0.51	0.95	2.17	4.12	8.07	15.52	29.99
1900	1.80	0.53	0.95	2.21	4.19	8.11	15.57	29.85
2000	1.92	0.52	0.96	2.21	4.17	8.10	15.47	29.88
2100	2.08	0.52	0.93	2.16	4.10	8.03	15.37	29.84
2200	2.25	0.52	0.93	2.10	4.03	7.92	15.26	29.16
2300	2.40	0.50	0.91	2.10	3.99	7.87	15.16	28.96
2400	2.56	0.49	0.91	2.12	4.01	7.87	15.08	28.58
2500	2.76	0.49	0.90	2.11	3.97	7.82	14.98	28.18
2600	3.16	0.46	0.85	2.04	3.87	7.69	14.76	27.77
2700	3.70	0.47	0.82	1.92	3.67	7.44	14.46	27.00
2800	4.25	0.44	0.78	1.76	3.45	7.12	14.00	26.08
2900	4.48	0.42	0.75	1.70	3.34	6.94	13.64	25.24
3000	4.23	0.42	0.78	1.79	3.47	7.06	13.64	24.99

* Step Attenuation above Thru Loss (TTL Logic 00000).

REV. OR
DAT-31575-PP+
110526
Page 1 of 9



IF/RF MICROWAVE COMPONENTS • ISO 9001 ISO 14001 AS9100 CERTIFIED • RoHS compliant
P.O. Box 350166, Brooklyn, New York 11235-0003 (718) 934-4500 Fax (718) 332-4661



The Design Engineers Search Engine finds the model you need, Instantly • For detailed performance specs & shopping online see



Digital Step Attenuator

DAT-31575-PP+

Typical Performance Data

TEST CONDITIONS: INPUT POWER=-10dBm, Vdd=+3V, TEMPERATURE=-45degC

FREQUENCY (MHz)	INPUT RETURN LOSS AT TTL CONTROL STATE							
	(dB)							
	000000 0 dB	000001 0.5 dB	000010 1.0 dB	000100 2.0 dB	001000 4.0 dB	010000 8.0 dB	100000 16 dB	111111 31.5 dB
0.5	21.01	23.45	24.82	24.51	29.30	49.47	27.71	25.61
1	21.05	23.53	24.90	24.62	29.45	51.00	27.73	25.61
5	21.13	23.62	25.01	24.68	29.53	50.15	27.67	25.56
10	21.13	23.64	24.96	24.69	29.58	47.73	27.70	25.59
50	20.46	22.66	23.87	23.58	27.60	36.56	28.86	26.68
100	19.53	21.52	22.55	22.30	25.47	32.39	32.01	29.17
150	19.22	21.07	22.11	21.85	24.98	31.77	35.15	30.78
200	19.95	22.01	23.16	22.89	26.48	34.90	31.21	28.06
250	21.19	23.66	25.04	24.68	29.29	47.91	27.88	25.63
300	22.06	24.78	26.51	25.81	30.80	37.19	25.98	24.14
350	21.42	23.70	25.23	24.21	27.34	29.95	25.10	23.78
400	19.87	21.71	22.92	22.01	24.18	26.85	25.22	24.28
450	18.84	20.38	21.47	20.63	22.58	25.46	26.25	25.69
500	18.42	19.86	20.92	20.05	21.97	25.16	28.06	27.77
550	18.46	19.96	21.16	20.20	22.12	25.71	30.11	29.72
600	18.93	20.52	21.76	20.68	22.71	26.78	31.16	30.10
700	19.49	20.99	22.42	20.93	22.82	26.43	28.62	27.75
800	18.60	19.92	21.26	19.70	21.18	23.96	26.61	26.80
900	17.55	18.67	19.88	18.37	19.64	22.10	25.61	26.59
1000	16.81	17.86	19.01	17.46	18.59	20.87	25.40	27.70
1100	16.81	17.82	18.90	17.32	18.41	20.70	26.85	31.37
1200	17.68	18.86	20.03	18.28	19.49	22.14	31.20	38.61
1300	19.38	20.80	22.28	20.08	21.45	24.98	40.79	33.90
1400	21.25	23.12	25.07	22.07	23.60	28.48	36.56	28.80
1500	23.29	25.50	28.88	23.66	25.33	31.26	29.46	25.68
1600	23.51	25.60	29.76	22.97	23.89	26.91	25.59	23.76
1700	21.29	22.75	25.53	20.47	21.03	22.87	23.49	22.90
1800	19.19	20.46	22.82	18.75	19.31	21.04	23.17	23.31
1900	18.14	19.38	21.63	17.98	18.68	20.75	23.78	24.33
2000	17.57	18.79	21.01	17.67	18.52	20.69	24.26	24.93
2100	17.36	18.71	20.99	17.77	18.68	21.02	24.07	24.16
2200	16.97	18.33	20.79	17.56	18.60	20.72	22.54	22.19
2300	16.02	17.33	19.65	16.62	17.45	19.15	19.97	19.65
2400	14.27	15.28	17.20	14.74	15.48	16.86	17.69	17.59
2500	12.09	12.91	14.36	12.57	13.32	14.64	15.81	16.04
2600	10.20	10.89	12.08	10.76	11.54	12.86	14.48	14.95
2700	8.61	9.24	10.26	9.27	10.11	11.58	13.54	14.27
2800	7.57	8.13	9.05	8.24	9.07	10.59	12.84	13.79
2900	7.02	7.51	8.35	7.61	8.39	9.87	12.31	13.44
3000	6.72	7.19	7.97	7.28	8.00	9.48	12.10	13.41



Digital Step Attenuator

DAT-31575-PP+

Typical Performance Data

TEST CONDITIONS: INPUT POWER=-10dBm, Vdd=+3V, TEMPERATURE=-45degC

FREQUENCY (MHz)	OUTPUT RETURN LOSS AT TTL CONTROL STATE (dB)							
	000000	000001	000010	000100	001000	010000	100000	111111
	0 dB	0.5 dB	1.0 dB	2.0 dB	4.0 dB	8.0 dB	16 dB	31.5 dB
0.5	21.09	22.53	22.57	32.25	42.70	32.67	36.34	23.70
1	21.16	22.56	22.67	32.23	43.25	32.92	36.59	23.80
5	21.18	22.60	22.70	32.36	42.68	32.61	36.17	23.75
10	21.21	22.62	22.69	32.22	42.26	32.73	36.23	23.82
50	20.39	21.61	21.66	29.12	37.52	34.21	36.80	24.85
100	19.20	20.26	20.30	26.34	34.05	38.76	37.14	27.32
150	18.91	19.95	20.05	25.85	34.09	47.93	38.56	28.51
200	19.78	20.97	21.04	27.88	37.78	37.60	38.57	25.90
250	21.21	22.61	22.73	32.37	40.19	32.29	35.31	23.68
300	21.85	23.42	23.58	33.68	34.41	29.63	31.87	22.70
350	20.90	22.08	22.21	28.40	29.81	28.24	29.57	22.66
400	19.45	20.34	20.49	25.24	27.79	27.89	28.39	23.78
450	18.46	19.34	19.42	23.80	27.23	28.56	28.28	25.48
500	18.14	18.91	19.00	23.54	27.50	29.60	28.74	27.25
550	18.15	18.99	19.10	23.79	28.10	30.80	29.53	28.18
600	18.23	19.07	19.16	23.91	28.66	31.46	29.94	28.37
700	18.23	18.95	19.04	23.85	28.31	31.15	29.39	28.62
800	17.97	18.63	18.73	23.30	27.42	30.02	28.44	28.28
900	17.06	17.64	17.75	21.80	25.14	27.38	25.89	28.97
1000	16.18	16.73	16.76	20.53	23.67	25.53	23.92	34.36
1100	16.46	16.93	16.94	20.91	24.18	26.09	23.95	41.62
1200	17.56	18.06	18.04	22.54	26.01	27.56	25.35	30.07
1300	18.97	19.58	19.51	24.96	28.41	28.92	27.26	25.58
1400	21.07	21.82	21.71	28.97	30.33	29.15	29.96	22.74
1500	23.73	24.74	24.59	37.93	30.60	28.19	32.93	21.06
1600	24.51	25.34	25.42	41.65	29.58	27.28	31.92	20.30
1700	23.33	23.77	23.97	32.17	28.19	26.41	29.20	19.96
1800	21.31	21.79	21.76	28.43	27.49	26.11	27.22	20.14
1900	20.24	20.57	20.76	27.48	27.91	26.41	27.09	20.55
2000	20.26	20.63	20.75	28.47	28.72	26.58	27.50	20.16
2100	20.66	21.04	21.12	28.02	26.55	24.64	25.46	18.90
2200	20.11	20.47	20.71	24.90	23.37	21.77	22.46	17.31
2300	18.37	18.74	18.88	21.71	20.83	19.65	19.93	16.11
2400	16.10	16.32	16.49	18.92	18.82	17.97	17.84	15.27
2500	13.47	13.65	13.85	16.09	16.66	16.30	15.94	14.63
2600	11.26	11.47	11.67	13.76	14.77	14.85	14.37	14.09
2700	9.67	9.87	10.07	12.11	13.33	13.84	13.38	14.02
2800	8.79	8.99	9.16	11.14	12.53	13.30	12.85	14.47
2900	8.43	8.59	8.73	10.71	12.09	13.01	12.57	15.20
3000	8.16	8.33	8.45	10.35	11.75	12.71	12.25	15.70

REV. OR
DAT-31575-PP+
110526
Page 3 of 9



IF/RF MICROWAVE COMPONENTS • ISO 9001 ISO 14001 AS9100 CERTIFIED • RoHS compliant
P.O. Box 350166, Brooklyn, New York 11235-0003 (718) 934-4500 Fax (718) 332-4661



The Design Engineers Search Engine finds the model you need, Instantly • For detailed performance specs & shopping online see



Digital Step Attenuator

DAT-31575-PP+

Typical Performance Data

TEST CONDITIONS: INPUT POWER=-10dBm, Vdd=+3V, TEMPERATURE=+25degC

FREQUENCY (MHz)	STEP ATTENUATION* AT TTL CONTROL STATE (dB)							
	000000 THRU LOSS	000001 0.5 dB	000010 1.0 dB	000100 2.0 dB	001000 4.0 dB	010000 8.0 dB	100000 16 dB	111111 31.5 dB
0.5	0.90	0.57	1.00	2.09	4.07	8.05	16.08	31.69
1	0.94	0.57	1.00	2.08	4.07	8.05	16.08	31.64
5	0.96	0.55	0.98	2.07	4.05	8.04	16.08	31.72
10	0.97	0.55	0.98	2.06	4.06	8.03	16.10	31.62
50	0.98	0.59	1.00	2.08	4.07	8.03	16.09	31.77
100	0.99	0.56	1.01	2.08	4.06	8.04	16.10	31.80
150	1.05	0.52	0.96	2.04	4.02	8.01	16.07	31.57
200	1.06	0.55	0.99	2.08	4.07	8.02	16.07	31.57
250	1.09	0.55	0.97	2.07	4.04	8.01	16.04	31.55
300	1.15	0.53	0.97	2.06	4.03	8.01	16.03	31.59
350	1.19	0.53	0.96	2.06	4.03	8.00	16.02	31.58
400	1.23	0.55	0.98	2.07	4.03	8.00	16.05	31.48
450	1.29	0.53	0.96	2.05	4.01	7.98	15.96	31.38
500	1.34	0.52	0.96	2.04	4.00	7.97	15.95	31.38
550	1.41	0.53	0.95	2.03	3.98	7.94	15.92	31.26
600	1.43	0.53	0.96	2.03	3.97	7.93	15.87	31.43
700	1.56	0.52	0.95	2.03	3.96	7.91	15.85	31.11
800	1.58	0.52	0.95	2.04	3.99	7.93	15.86	30.97
900	1.57	0.51	0.95	2.07	4.03	7.98	15.84	31.08
1000	1.57	0.52	0.95	2.10	4.05	8.01	15.79	30.77
1100	1.65	0.51	0.94	2.08	4.03	7.97	15.74	30.70
1200	1.75	0.51	0.94	2.05	4.00	7.92	15.69	30.41
1300	1.88	0.50	0.94	2.02	3.93	7.85	15.58	30.37
1400	2.00	0.51	0.94	1.99	3.90	7.82	15.52	30.11
1500	2.10	0.50	0.95	2.00	3.89	7.80	15.46	29.97
1600	2.13	0.51	0.94	2.04	3.93	7.84	15.38	29.75
1700	2.14	0.50	0.92	2.09	4.00	7.90	15.38	29.75
1800	2.10	0.49	0.92	2.16	4.10	7.98	15.39	29.80
1900	2.12	0.48	0.91	2.19	4.13	8.01	15.33	29.61
2000	2.23	0.49	0.91	2.16	4.09	7.95	15.24	29.56
2100	2.39	0.50	0.92	2.13	4.02	7.88	15.15	29.19
2200	2.57	0.49	0.91	2.06	3.94	7.80	15.03	28.97
2300	2.70	0.48	0.90	2.05	3.91	7.76	14.95	28.78
2400	2.83	0.48	0.90	2.06	3.92	7.76	14.85	28.43
2500	2.99	0.48	0.89	2.06	3.92	7.73	14.78	27.96
2600	3.32	0.47	0.86	2.04	3.85	7.64	14.61	27.76
2700	3.84	0.46	0.83	1.92	3.68	7.42	14.36	27.16
2800	4.44	0.44	0.78	1.78	3.45	7.13	13.97	25.93
2900	4.84	0.43	0.75	1.71	3.33	6.92	13.54	24.99
3000	4.79	0.40	0.74	1.78	3.42	6.99	13.40	24.70

* Step Attenuation above Thru Loss (TTL Logic 00000).

REV. OR
DAT-31575-PP+
110526
Page 4 of 9



IF/RF MICROWAVE COMPONENTS • ISO 9001 ISO 14001 AS9100 CERTIFIED • RoHS compliant
P.O. Box 350166, Brooklyn, New York 11235-0003 (718) 934-4500 Fax (718) 332-4661



The Design Engineers Search Engine finds the model you need, Instantly • For detailed performance specs & shopping online see



Digital Step Attenuator

DAT-31575-PP+

Typical Performance Data

TEST CONDITIONS: INPUT POWER=-10dBm, Vdd=+3V, TEMPERATURE=+25degC

FREQUENCY (MHz)	INPUT RETURN LOSS AT TTL CONTROL STATE							
	(dB)							
	000000 0 dB	000001 0.5 dB	000010 1.0 dB	000100 2.0 dB	001000 4.0 dB	010000 8.0 dB	100000 16 dB	111111 31.5 dB
0.5	20.10	21.79	22.57	21.51	23.56	27.30	42.97	45.46
1	20.16	21.85	22.66	21.59	23.66	27.39	43.57	45.09
5	20.25	21.98	22.78	21.67	23.75	27.51	43.74	44.39
10	20.26	21.98	22.79	21.69	23.77	27.52	43.47	44.41
50	20.16	21.88	22.62	21.58	23.60	27.33	41.91	45.95
100	20.05	21.75	22.57	21.49	23.48	27.05	39.90	45.53
150	19.87	21.51	22.28	21.23	23.20	26.58	37.47	41.93
200	19.71	21.27	22.09	21.01	22.91	26.16	35.79	40.32
250	19.44	20.93	21.75	20.65	22.39	25.53	33.83	38.54
300	19.16	20.54	21.36	20.25	21.86	24.84	32.26	36.65
350	18.84	20.19	21.06	19.89	21.43	24.22	31.08	35.16
400	18.51	19.83	20.66	19.49	20.95	23.54	29.94	34.08
450	18.26	19.49	20.39	19.16	20.51	23.02	28.91	33.03
500	17.98	19.12	20.06	18.78	20.03	22.39	28.01	31.90
550	17.72	18.87	19.69	18.39	19.63	21.79	27.22	31.00
600	17.45	18.51	19.38	18.02	19.22	21.31	26.46	30.15
700	17.01	18.06	18.89	17.50	18.48	20.40	25.14	28.54
800	16.80	17.75	18.57	17.10	17.97	19.78	24.24	27.39
900	16.80	17.75	18.67	17.01	17.74	19.48	23.88	26.56
1000	17.26	18.26	19.14	17.26	17.96	19.59	23.94	26.39
1100	18.04	19.00	20.00	17.83	18.46	20.02	24.43	26.58
1200	18.85	19.86	20.94	18.45	19.05	20.67	25.28	26.86
1300	19.74	20.82	22.09	19.18	19.74	21.46	26.57	27.57
1400	20.59	21.78	23.21	19.92	20.54	22.45	28.37	28.31
1500	21.33	22.60	24.28	20.55	21.17	23.34	30.63	29.42
1600	21.71	23.05	25.11	20.82	21.41	23.97	34.46	31.36
1700	21.46	22.84	25.26	20.60	21.21	23.94	39.47	33.38
1800	20.66	22.16	24.50	20.01	20.61	23.38	38.92	34.46
1900	19.68	21.06	23.52	19.23	20.01	22.75	35.48	34.45
2000	18.56	19.89	22.27	18.43	19.19	21.88	31.99	33.55
2100	17.76	19.08	21.36	17.80	18.66	21.32	30.09	31.21
2200	16.73	17.97	20.25	17.05	17.94	20.67	27.89	28.70
2300	15.70	16.86	19.09	16.08	17.07	19.64	25.39	26.14
2400	14.48	15.58	17.59	14.95	15.88	18.25	22.81	23.70
2500	13.12	14.07	15.83	13.56	14.43	16.50	20.21	21.32
2600	11.64	12.49	13.92	12.06	12.89	14.77	17.92	19.12
2700	10.08	10.77	12.01	10.49	11.33	13.03	16.02	17.39
2800	8.75	9.35	10.41	9.20	9.95	11.53	14.38	15.86
2900	7.85	8.36	9.25	8.24	8.92	10.34	13.06	14.59
3000	7.18	7.64	8.43	7.55	8.15	9.48	12.09	13.65

REV. OR
DAT-31575-PP+
110526
Page 5 of 9



IF/RF MICROWAVE COMPONENTS • ISO 9001 ISO 14001 AS9100 CERTIFIED • RoHS compliant
P.O. Box 350166, Brooklyn, New York 11235-0003 (718) 934-4500 Fax (718) 332-4661



The Design Engineers Search Engine finds the model you need, Instantly • For detailed performance specs & shopping online see



Digital Step Attenuator

DAT-31575-PP+

Typical Performance Data

TEST CONDITIONS: INPUT POWER=-10dBm, Vdd=+3V, TEMPERATURE=+25degC

FREQUENCY (MHz)	OUTPUT RETURN LOSS AT TTL CONTROL STATE (dB)							
	000000	000001	000010	000100	001000	010000	100000	111111
	0 dB	0.5 dB	1.0 dB	2.0 dB	4.0 dB	8.0 dB	16 dB	31.5 dB
0.5	20.07	20.88	20.65	26.25	32.24	35.35	29.01	33.70
1	20.19	20.95	20.72	26.35	32.31	35.43	29.11	33.77
5	20.21	21.03	20.79	26.48	32.53	35.65	29.20	33.61
10	20.25	21.07	20.84	26.48	32.53	35.53	29.26	33.65
50	20.12	20.94	20.75	26.34	32.16	35.36	29.04	33.89
100	19.90	20.73	20.49	25.84	31.31	33.78	28.56	34.14
150	19.66	20.47	20.23	25.42	30.20	32.68	28.03	34.16
200	19.34	20.11	19.90	24.68	29.03	31.04	27.18	34.76
250	18.99	19.68	19.52	24.07	28.04	30.01	26.44	35.04
300	18.60	19.27	19.14	23.39	27.03	28.85	25.77	35.38
350	18.25	18.87	18.74	22.82	26.14	27.76	25.09	35.04
400	17.87	18.45	18.35	22.28	25.40	26.93	24.29	35.31
450	17.54	18.11	18.01	21.79	24.74	26.15	23.71	35.29
500	17.22	17.70	17.68	21.26	24.13	25.40	23.07	34.80
550	17.01	17.49	17.40	20.85	23.60	24.81	22.63	34.31
600	16.78	17.23	17.14	20.53	23.09	24.26	22.02	33.45
700	16.59	16.99	16.88	20.20	22.68	23.56	21.39	32.35
800	16.56	16.93	16.79	20.20	22.40	23.06	20.84	30.95
900	16.68	17.00	16.82	20.21	22.44	22.79	20.49	29.42
1000	17.16	17.39	17.23	20.73	22.79	22.92	20.42	28.39
1100	17.69	17.90	17.67	21.44	23.21	23.04	20.47	27.20
1200	18.21	18.36	18.06	21.92	23.61	23.23	20.63	26.20
1300	18.66	18.80	18.52	22.46	24.00	23.53	21.01	25.15
1400	19.15	19.34	19.04	23.10	24.31	23.97	21.67	24.11
1500	19.85	20.10	19.82	23.95	24.98	24.64	22.65	23.12
1600	20.85	21.16	20.92	25.50	26.00	25.58	24.36	22.15
1700	22.47	22.77	22.39	28.23	27.36	26.77	26.87	21.23
1800	23.68	24.11	23.83	33.56	29.02	28.06	30.89	20.56
1900	24.64	25.22	24.98	41.17	29.08	28.01	37.78	19.87
2000	23.86	24.13	24.05	32.09	27.51	26.77	34.03	19.23
2100	21.59	21.74	21.67	26.40	25.01	24.69	27.25	18.74
2200	19.41	19.43	19.44	22.97	22.90	22.63	23.49	18.32
2300	17.41	17.47	17.50	21.06	21.65	21.30	21.20	18.26
2400	15.70	15.81	15.82	19.37	20.42	20.36	19.46	18.50
2500	13.87	14.00	14.13	17.44	18.87	18.90	17.71	18.50
2600	12.40	12.55	12.71	15.83	17.55	17.84	16.56	18.61
2700	11.20	11.39	11.55	14.56	16.35	17.00	15.78	18.84
2800	10.30	10.53	10.65	13.49	15.32	16.18	15.01	19.18
2900	9.64	9.84	9.97	12.55	14.28	15.30	14.31	19.21
3000	8.89	9.06	9.19	11.54	13.11	14.10	13.27	18.44



Digital Step Attenuator

DAT-31575-PP+

Typical Performance Data

TEST CONDITIONS: INPUT POWER=-10dBm, Vdd=+3V, TEMPERATURE=+85degC

FREQUENCY (MHz)	STEP ATTENUATION* AT TTL CONTROL STATE (dB)							
	000000 THRU LOSS	000001 0.5 dB	000010 1.0 dB	000100 2.0 dB	001000 4.0 dB	010000 8.0 dB	100000 16 dB	111111 31.5 dB
0.5	1.03	0.53	0.96	2.04	4.01	7.96	15.98	31.46
1	1.07	0.54	0.97	2.04	4.01	7.96	15.98	31.52
5	1.07	0.54	0.97	2.05	4.01	7.97	15.99	31.46
10	1.08	0.54	0.97	2.05	4.02	7.96	16.01	31.39
50	1.10	0.56	0.98	2.06	4.03	7.98	16.00	31.42
100	1.13	0.55	0.98	2.06	4.02	7.97	15.99	31.59
150	1.16	0.55	0.97	2.04	4.02	7.95	15.98	31.49
200	1.20	0.55	0.97	2.05	4.01	7.96	15.99	31.41
250	1.24	0.53	0.97	2.04	4.00	7.95	15.94	31.40
300	1.29	0.53	0.97	2.05	4.00	7.94	15.96	31.45
350	1.35	0.53	0.97	2.04	3.99	7.96	15.93	31.34
400	1.42	0.52	0.95	2.02	3.97	7.92	15.90	31.44
450	1.47	0.52	0.95	2.02	3.97	7.91	15.88	31.39
500	1.53	0.51	0.94	2.01	3.96	7.90	15.84	31.15
550	1.60	0.52	0.94	2.00	3.94	7.88	15.85	31.10
600	1.63	0.51	0.94	2.00	3.95	7.89	15.84	31.07
700	1.77	0.51	0.94	2.00	3.95	7.88	15.78	30.93
800	1.81	0.51	0.95	2.02	3.95	7.90	15.78	30.69
900	1.79	0.53	0.95	2.06	4.02	7.95	15.77	30.72
1000	1.82	0.52	0.95	2.07	4.02	7.92	15.71	30.79
1100	1.89	0.51	0.94	2.07	4.01	7.89	15.61	30.55
1200	1.99	0.51	0.94	2.04	3.97	7.86	15.58	30.33
1300	2.13	0.51	0.94	2.00	3.91	7.79	15.49	30.05
1400	2.27	0.51	0.95	1.99	3.90	7.79	15.44	29.83
1500	2.39	0.51	0.95	2.01	3.90	7.80	15.45	29.75
1600	2.44	0.50	0.94	2.04	3.95	7.82	15.35	29.55
1700	2.45	0.48	0.93	2.10	4.00	7.90	15.30	29.75
1800	2.41	0.49	0.93	2.15	4.07	7.93	15.25	29.66
1900	2.41	0.49	0.92	2.18	4.10	7.94	15.20	29.77
2000	2.50	0.50	0.92	2.15	4.05	7.89	15.10	29.65
2100	2.64	0.49	0.92	2.11	3.99	7.80	15.03	29.09
2200	2.83	0.48	0.90	2.06	3.90	7.73	14.91	29.03
2300	2.99	0.48	0.91	2.03	3.88	7.68	14.81	28.63
2400	3.13	0.48	0.90	2.04	3.87	7.67	14.71	27.99
2500	3.30	0.48	0.88	2.06	3.85	7.61	14.60	27.85
2600	3.64	0.48	0.86	2.03	3.79	7.53	14.44	27.62
2700	4.13	0.46	0.83	1.89	3.60	7.33	14.15	26.75
2800	4.67	0.43	0.78	1.77	3.43	7.07	13.81	26.00
2900	5.03	0.43	0.76	1.73	3.35	6.92	13.49	25.19
3000	4.97	0.42	0.75	1.80	3.44	7.02	13.41	24.90

* Step Attenuation above Thru Loss (TTL Logic 00000).

REV. OR
DAT-31575-PP+
110526
Page 7 of 9



IF/RF MICROWAVE COMPONENTS • ISO 9001 ISO 14001 AS9100 CERTIFIED • RoHS compliant
P.O. Box 350166, Brooklyn, New York 11235-0003 (718) 934-4500 Fax (718) 332-4661



The Design Engineers Search Engine finds the model you need, Instantly • For detailed performance specs & shopping online see



Digital Step Attenuator

DAT-31575-PP+

Typical Performance Data

TEST CONDITIONS: INPUT POWER=-10dBm, Vdd=+3V, TEMPERATURE=+85degC

FREQUENCY (MHz)	INPUT RETURN LOSS AT TTL CONTROL STATE							
	(dB)							
	000000 0 dB	000001 0.5 dB	000010 1.0 dB	000100 2.0 dB	001000 4.0 dB	010000 8.0 dB	100000 16 dB	111111 31.5 dB
0.5	18.90	20.10	20.55	19.10	20.01	21.54	25.96	28.55
1	18.93	20.12	20.57	19.13	20.03	21.56	25.96	28.52
5	19.01	20.22	20.66	19.21	20.12	21.63	26.04	28.68
10	19.04	20.24	20.70	19.25	20.14	21.65	26.09	28.73
50	19.16	20.37	20.87	19.41	20.36	21.88	26.45	29.23
100	19.74	21.07	21.62	20.04	21.03	22.83	28.10	31.40
150	19.87	21.24	21.84	20.22	21.31	23.16	28.82	32.73
200	19.39	20.56	21.20	19.63	20.65	22.38	27.12	30.21
250	18.32	19.33	19.85	18.52	19.34	20.86	24.66	26.94
300	17.40	18.33	18.83	17.53	18.25	19.59	22.96	24.88
350	16.83	17.70	18.18	16.91	17.63	18.81	21.96	23.70
400	16.61	17.46	17.99	16.67	17.31	18.48	21.50	23.21
450	16.70	17.59	18.11	16.73	17.34	18.51	21.55	23.18
500	16.94	17.82	18.37	16.93	17.56	18.74	21.87	23.51
550	17.22	18.11	18.73	17.18	17.82	19.00	22.19	24.01
600	17.38	18.28	19.00	17.35	17.96	19.16	22.60	24.56
700	17.14	18.01	18.78	17.00	17.57	18.78	22.28	24.37
800	16.42	17.20	17.95	16.19	16.63	17.73	20.89	22.63
900	15.99	16.73	17.40	15.62	15.96	16.90	19.63	21.16
1000	16.25	16.88	17.57	15.62	15.84	16.62	19.01	20.18
1100	17.06	17.67	18.26	16.14	16.18	16.83	18.98	19.94
1200	18.11	18.72	19.30	16.96	16.94	17.45	19.58	20.18
1300	19.32	19.98	20.63	17.95	17.89	18.44	20.56	20.87
1400	20.32	21.11	21.89	18.82	18.77	19.39	21.83	21.91
1500	20.82	21.68	22.58	19.22	19.20	20.01	22.91	22.98
1600	20.65	21.53	22.64	19.16	19.24	20.18	23.80	23.96
1700	20.37	21.26	22.33	19.05	19.18	20.29	24.35	24.30
1800	19.79	20.75	21.76	18.96	19.22	20.65	24.89	24.52
1900	19.59	20.57	21.65	19.15	19.67	21.49	26.26	24.99
2000	19.40	20.68	22.13	19.44	20.13	22.65	29.74	26.16
2100	19.40	20.78	23.15	19.45	20.31	23.54	39.37	27.86
2200	18.26	19.69	22.47	18.20	19.14	22.35	36.19	29.27
2300	16.28	17.52	19.94	16.24	17.10	19.75	27.23	28.22
2400	14.20	15.23	17.19	14.31	15.15	17.44	23.15	25.86
2500	12.56	13.41	15.03	12.72	13.51	15.54	20.55	23.52
2600	11.22	12.00	13.43	11.53	12.31	14.24	18.78	21.73
2700	10.14	10.84	12.13	10.50	11.27	13.13	17.37	20.25
2800	9.26	9.92	11.11	9.70	10.42	12.21	16.11	18.89
2900	8.69	9.31	10.35	9.10	9.76	11.41	15.06	17.57
3000	8.18	8.72	9.68	8.56	9.16	10.69	14.04	16.36

REV. OR
DAT-31575-PP+
110526
Page 8 of 9



IF/RF MICROWAVE COMPONENTS • ISO 9001 ISO 14001 AS9100 CERTIFIED • RoHS compliant
P.O. Box 350166, Brooklyn, New York 11235-0003 (718) 934-4500 Fax (718) 332-4661



The Design Engineers Search Engine finds the model you need, Instantly • For detailed performance specs & shopping online see



Digital Step Attenuator

DAT-31575-PP+

Typical Performance Data

TEST CONDITIONS: INPUT POWER=-10dBm, Vdd=+3V, TEMPERATURE=+85degC

FREQUENCY (MHz)	OUTPUT RETURN LOSS AT TTL CONTROL STATE (dB)							
	000000	000001	000010	000100	001000	010000	100000	111111
	0 dB	0.5 dB	1.0 dB	2.0 dB	4.0 dB	8.0 dB	16 dB	31.5 dB
0.5	18.86	19.25	18.85	22.55	24.93	24.84	21.91	32.50
1	18.87	19.26	18.88	22.56	24.89	24.80	21.87	32.25
5	18.92	19.33	18.94	22.59	24.92	24.84	21.94	32.38
10	18.97	19.38	18.98	22.67	24.97	24.90	21.97	32.40
50	19.21	19.63	19.25	23.10	25.55	25.44	22.43	33.83
100	19.80	20.27	19.89	24.10	27.05	27.03	23.55	39.42
150	19.76	20.22	19.86	24.10	26.96	27.16	23.74	37.16
200	18.89	19.32	19.02	22.54	24.75	25.11	22.45	31.08
250	17.69	18.01	17.71	20.68	22.51	22.69	20.72	27.53
300	16.74	17.01	16.78	19.41	21.08	21.23	19.42	25.43
350	16.16	16.45	16.24	18.80	20.29	20.42	18.65	24.39
400	16.00	16.26	16.06	18.60	20.08	20.11	18.38	23.94
450	16.08	16.35	16.15	18.74	20.17	20.22	18.37	24.07
500	16.32	16.57	16.34	19.14	20.61	20.53	18.59	24.45
550	16.63	16.93	16.69	19.57	21.06	20.98	18.94	25.08
600	16.78	17.03	16.88	19.83	21.39	21.29	19.15	25.68
700	16.67	16.93	16.72	19.73	21.25	21.11	19.00	25.70
800	16.09	16.30	16.11	18.91	20.26	20.05	18.03	24.08
900	15.66	15.77	15.54	18.16	19.29	18.88	17.02	22.16
1000	15.79	15.81	15.52	17.99	18.77	18.19	16.38	20.67
1100	16.31	16.25	15.89	18.27	18.77	18.00	16.23	19.79
1200	17.19	17.08	16.60	18.92	19.18	18.28	16.56	19.47
1300	18.18	18.07	17.59	19.93	19.95	19.01	17.30	19.62
1400	19.11	18.96	18.43	20.88	20.85	19.90	18.23	19.91
1500	19.79	19.69	19.12	21.80	21.65	20.73	19.09	20.19
1600	20.29	20.19	19.68	22.51	22.18	21.36	19.83	20.23
1700	21.04	20.95	20.51	23.13	22.63	21.76	20.50	19.74
1800	22.48	22.34	21.83	24.27	23.06	22.40	21.91	19.25
1900	25.74	25.79	25.09	26.15	23.66	23.23	24.38	18.55
2000	31.12	31.24	30.16	28.14	24.24	24.42	29.41	18.13
2100	26.56	26.45	26.29	27.34	24.49	24.73	32.54	18.07
2200	20.62	20.56	20.51	23.63	23.14	23.41	25.00	18.28
2300	17.18	17.20	17.12	20.84	21.81	21.89	21.11	19.20
2400	14.82	14.81	14.84	18.60	20.17	20.29	18.56	20.54
2500	13.13	13.25	13.23	16.87	18.64	19.02	17.00	21.78
2600	12.15	12.30	12.35	15.86	17.84	18.41	16.46	23.32
2700	11.63	11.79	11.90	15.37	17.49	18.23	16.29	24.90
2800	11.24	11.39	11.51	14.87	16.90	17.79	15.99	25.35
2900	10.75	10.95	11.06	14.12	15.97	16.86	15.32	24.12
3000	9.90	10.08	10.17	12.87	14.46	15.29	13.99	21.46

REV. OR
DAT-31575-PP+
110526
Page 9 of 9



IF/RF MICROWAVE COMPONENTS • ISO 9001 ISO 14001 AS9100 CERTIFIED • RoHS compliant
P.O. Box 350166, Brooklyn, New York 11235-0003 (718) 934-4500 Fax (718) 332-4661



The Design Engineers Search Engine finds the model you need, Instantly • For detailed performance specs & shopping online see



Digital Step Attenuator

Typical Performance Curves

DAT-31575-PP+

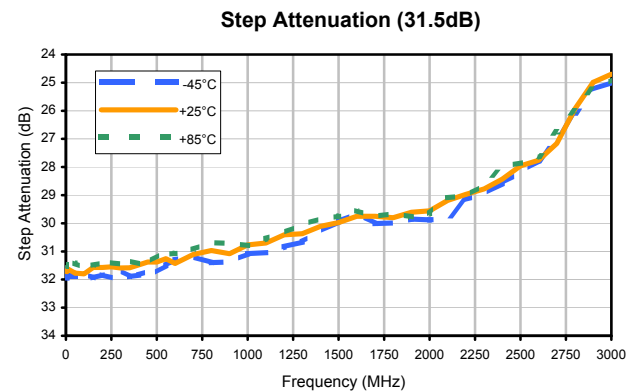
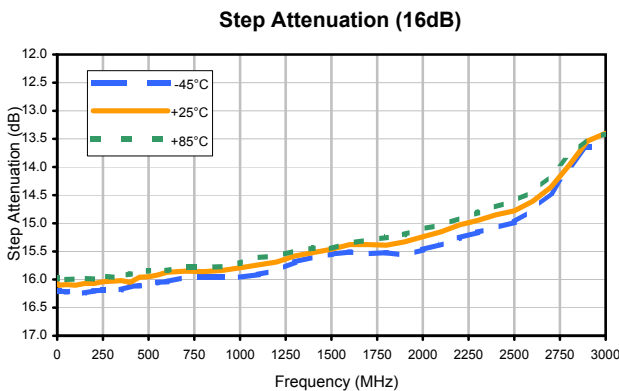
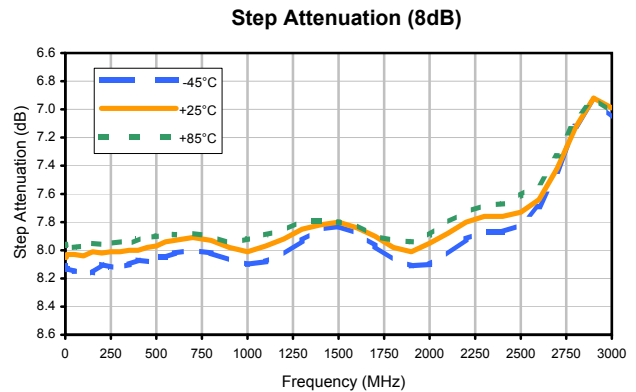
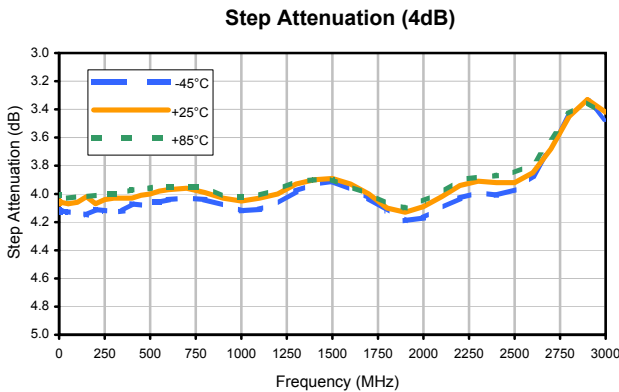
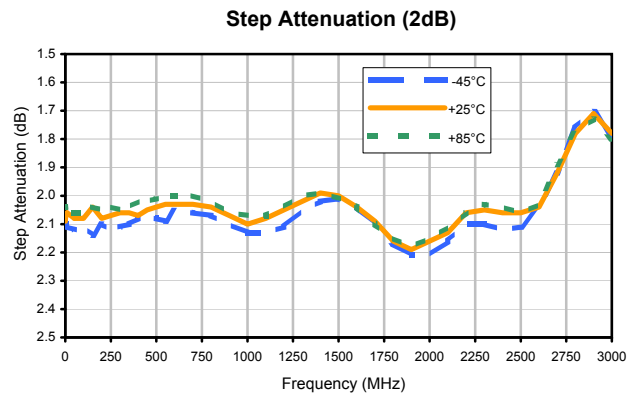
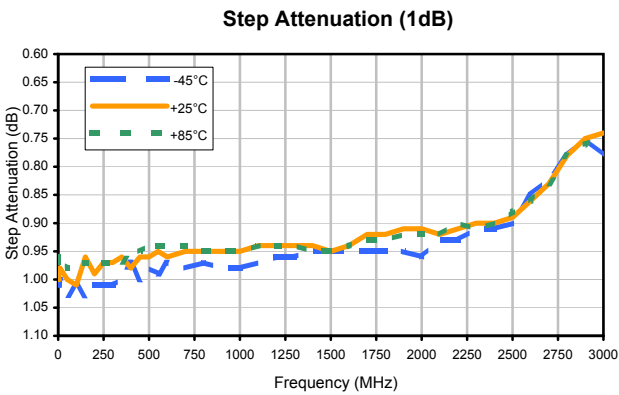
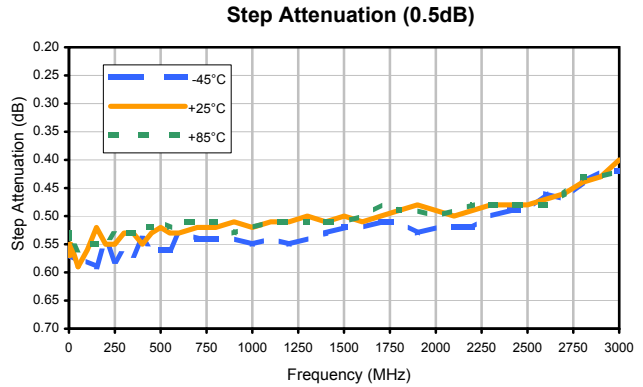
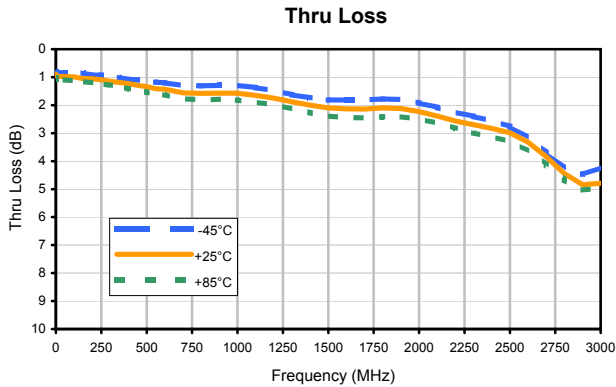

IF/RF MICROWAVE COMPONENTS • ISO 9001 ISO 14001 AS 9100 CERTIFIED • RoHS compliant
 P.O. Box 350166, Brooklyn, New York 11235-0003 (718) 934-4500 Fax (718) 332-4661



The Design Engineers Search Engine finds the model you need, Instantly • For detailed performance specs & shopping online see

REV. OR
 DAT-31575-PP+
 110526
 Page 1 of 3



Digital Step Attenuator

Typical Performance Curves

DAT-31575-PP+

Input Return Loss (0dB)

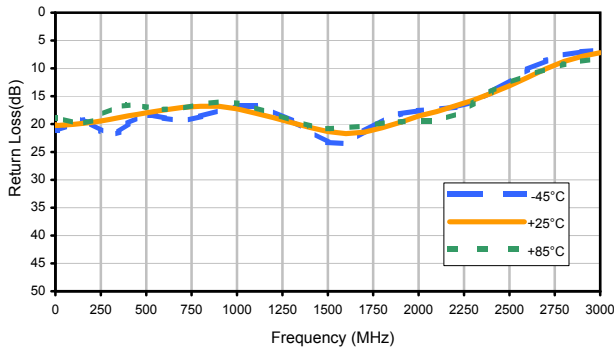

Input Return Loss (0.5dB)

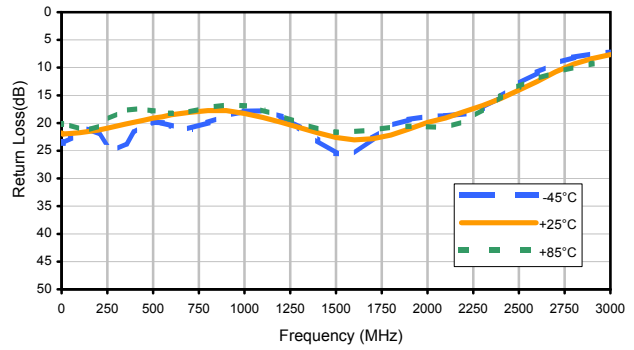

Input Return Loss (1dB)

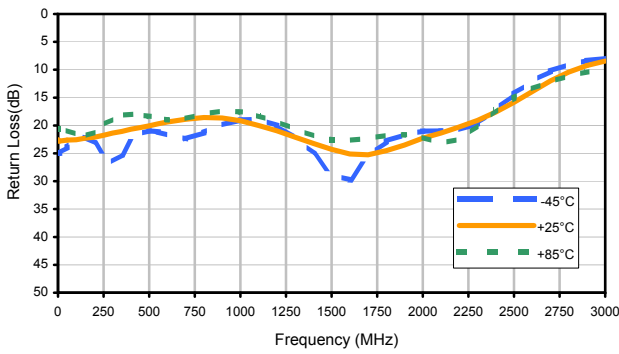

Input Return Loss (2dB)

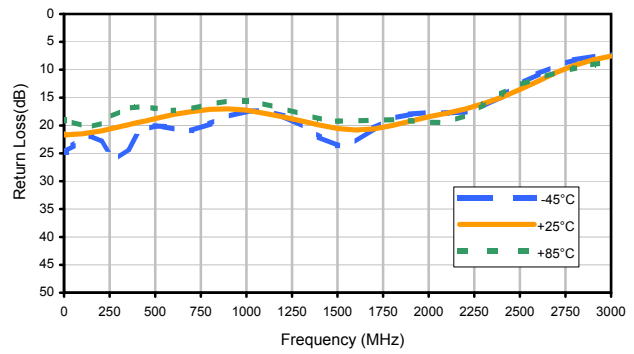

Input Return Loss (4dB)

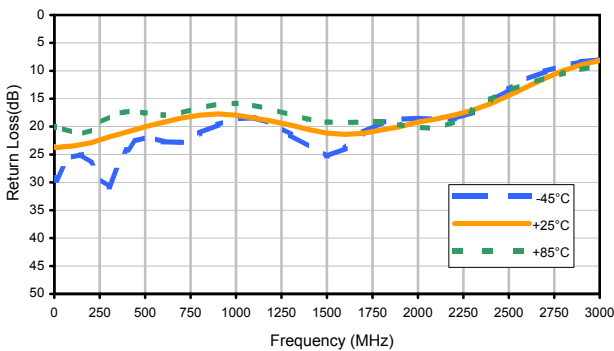

Input Return Loss (8dB)

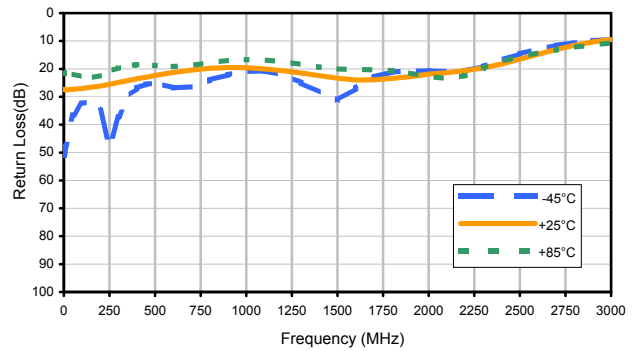

Input Return Loss (16dB)

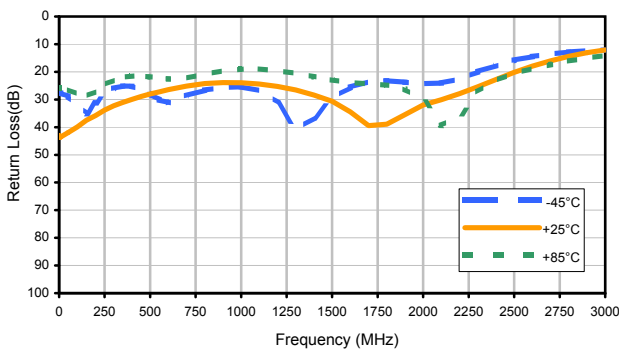

Input Return Loss (31.5dB)

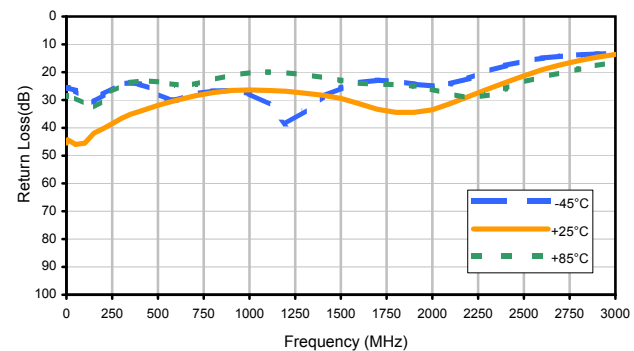

IF/RF MICROWAVE COMPONENTS • ISO 9001 ISO 14001 AS 9100 CERTIFIED • RoHS compliant
 P.O. Box 350166, Brooklyn, New York 11235-0003 (718) 934-4500 Fax (718) 332-4661



The Design Engineers Search Engine finds the model you need, Instantly • For detailed performance specs & shopping online see

REV. OR
 DAT-31575-PP+
 110526
 Page 2 of 3



Digital Step Attenuator

Typical Performance Curves

DAT-31575-PP+

Output Return Loss (0dB)

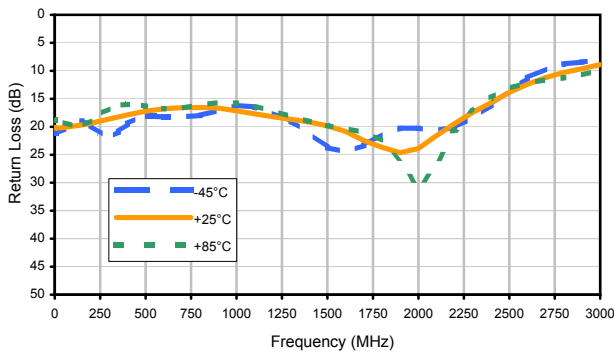

Output Return Loss (0.5dB)

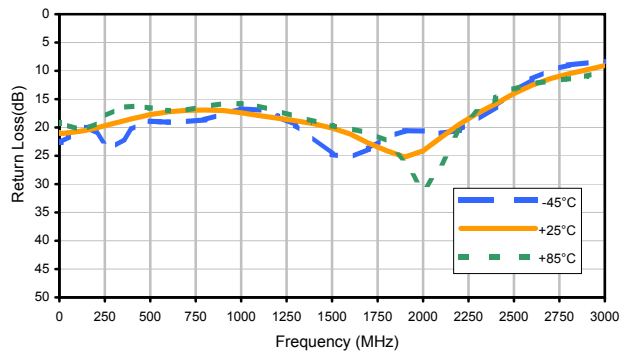

Output Return Loss (1dB)

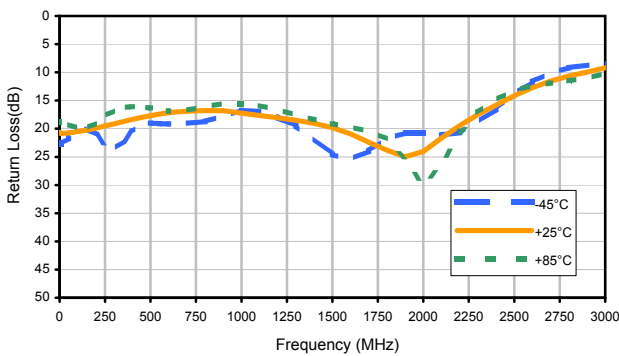

Output Return Loss (2dB)

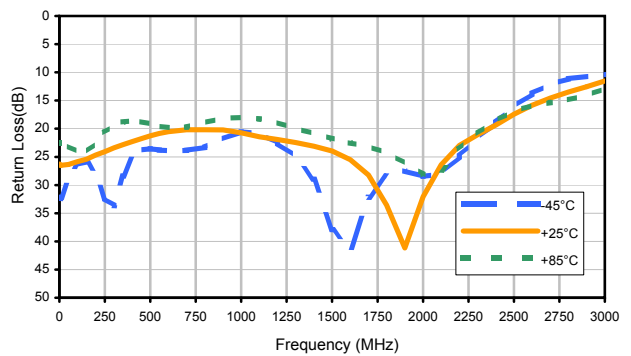

Output Return Loss (4dB)

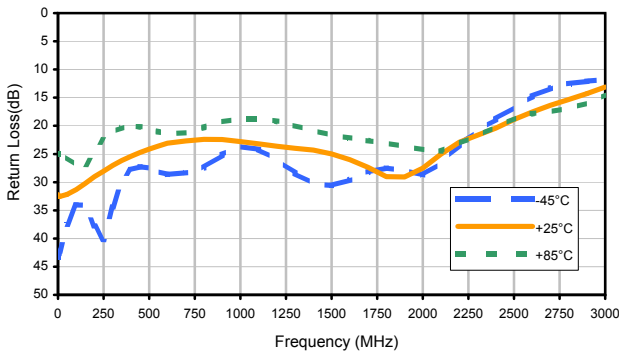

Output Return Loss(8dB)

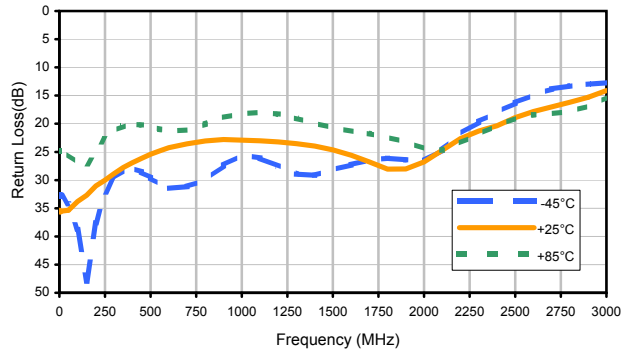

Output Return Loss(16dB)

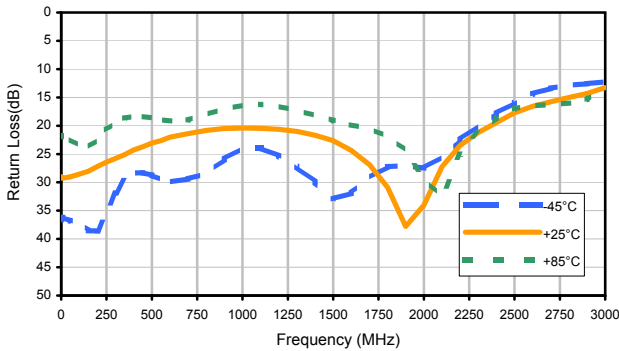

Output Return Loss (31.5dB)

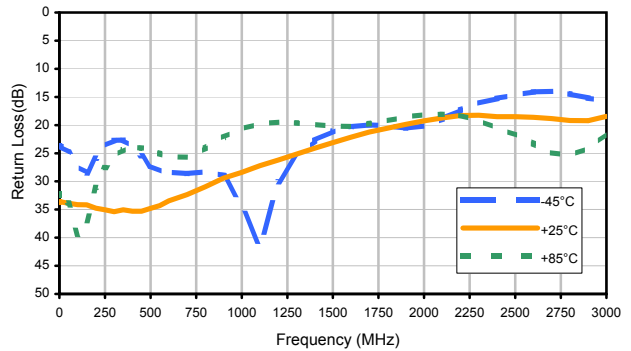

IF/RF MICROWAVE COMPONENTS • ISO 9001 ISO 14001 AS 9100 CERTIFIED • RoHS compliant
P.O. Box 350166, Brooklyn, New York 11235-0003 (718) 934-4500 Fax (718) 332-4661



The Design Engineers Search Engine finds the model you need, Instantly • For detailed performance specs & shopping online see

REV. OR
DAT-31575-PP+
110526
Page 3 of 3



Outline Dimensions

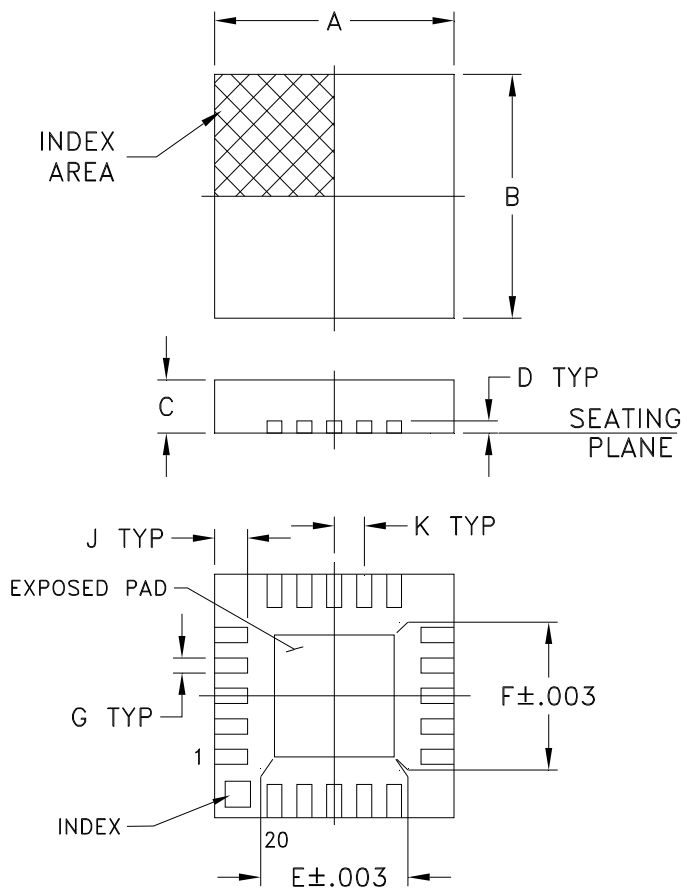

PCB Land Pattern

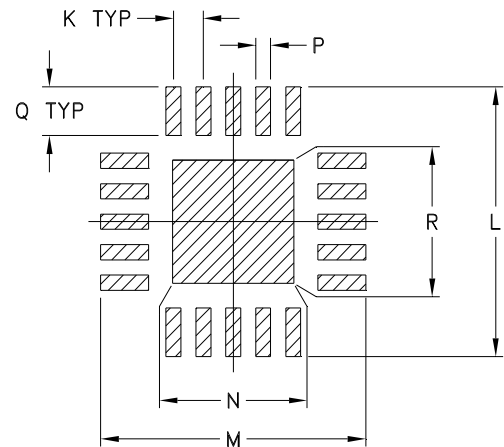

Suggested Layout,
Tolerance to be within $\pm .002$

CASE #	A	B	C	D	E	F	G	H	J	K
DG983-1	.157 (4.00)	.157 (4.00)	.035 (0.90)	.008 (0.20)	.081 (2.06)	.081 (2.06)	.010 (0.25)	-- --	.022 (0.56)	.020 (0.50)

CASE #	L	M	N	P	Q	R	WT. GRAM
DG983-1	.177 (4.50)	.177 (4.50)	.081 (2.06)	.010 (0.25)	.032 (0.81)	.081 (2.06)	.04

Dimensions are in inches (mm). Tolerances: 2 Pl. $\pm .01$; 3 Pl. $\pm .005$

Notes:

- Case material: Plastic.
- Termination finish:
For RoHS Case Styles: Tin plate. All models, (+) suffix.
For RoHS-5 Case Styles: Tin-Lead plate. All models, no (+) suffix.

Tape & Reel Packaging TR-F87

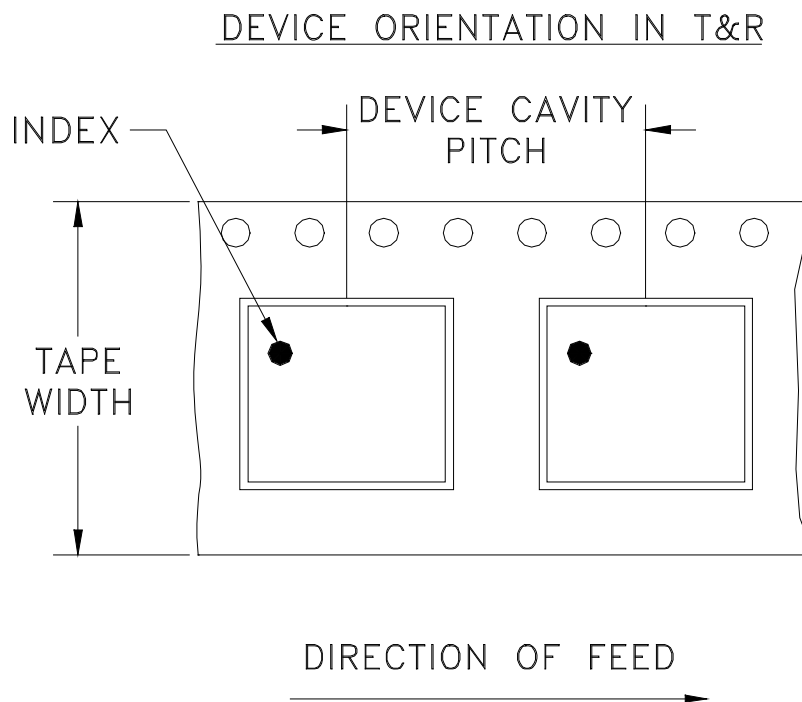

Tape Width, mm	Device Cavity Pitch, mm	Reel Size, inches	Devices per Reel	
12	8	7	Small quantity standards (see note)	20
				50
				100
				200
				500
		1000		
		13	Standard	3000

Note : Please Consult individual model data sheet to determine device per reel availability

Mini-Circuits carrier tape materials provide protection from ESD (Electro-Static Discharge) during handling and transportation. Tapes are static dissipative and comply with industry standards EIA-481/EIA-541.

Go to: www.minicircuits.com/pages/pdfs/tape.pdf

Mini-Circuits®

INTERNET <http://www.minicircuits.com>

P.O. Box 350166, Brooklyn, New York 11235-0003 (718) 934-4500 Fax (718) 332-4661

Distribution Centers NORTH AMERICA 800-654-7949 • 417-335-5935 • Fax 417-335-5945 • EUROPE 44-1252-832600 • Fax 44-1252-837010

Mini-Circuits ISO 9001 & ISO 14001 Certified

THIRD ANGLE PROJECTION

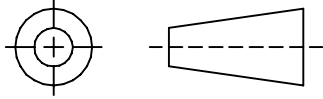

REVISIONS

REV	ECN No.	DESCRIPTION	DATE	DR	AUTH
OR	M96972	NEW RELEASE (FROM RAVON)	03/05	DK	HH
A	M102713	MODIFIED HATCH, NOTES & ADDED "...WITH SMOBC"	01/06	GT	IL
B	M103510	ADD R7 & CHANGE LOCATION DESIGNATORS	70/09	EM	KN
B	R63339	ADD R7 & CHANGE LOCATION DESIGNATORS	07/09	EM	KN

SUGGESTED MOUNTING CONFIGURATION

FOR DG983-1 CASE STYLE, qp PIN CONNECTIONS, 75 Ω.

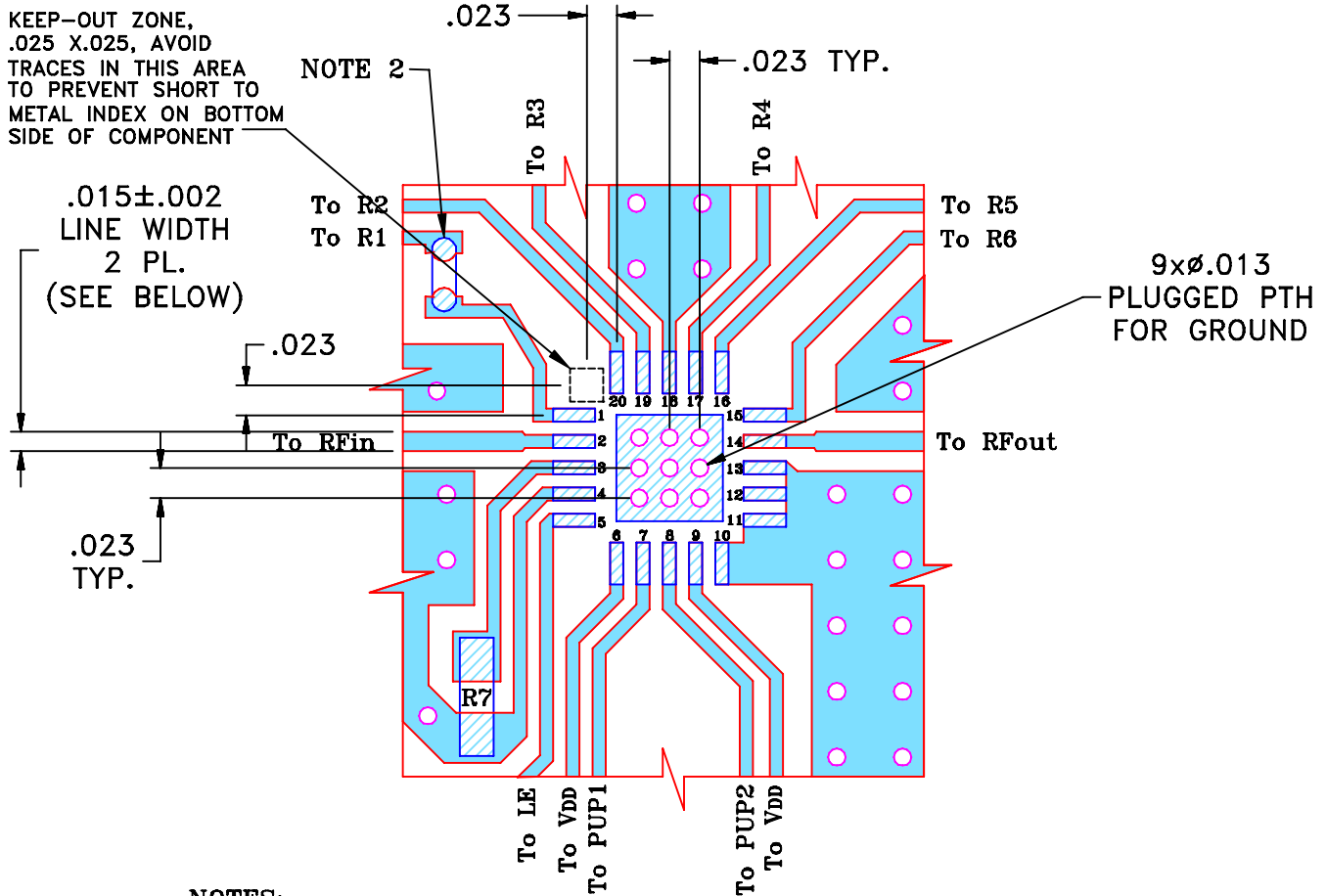

NOTES:

- TRACE WIDTH IS SHOWN FOR FR4 WITH DIELECTRIC THICKNESS. $.025 \pm .002$ ". COPPER: 1/2 OZ. EACH SIDE. FOR OTHER MATERIALS TRACE WIDTH MAY NEED TO BE MODIFIED.
- 0603, 0402 SIZES CHIP FOOT PRINTS SHOWN FOR REFERENCE, VALUES OF RESISTORS WILL VARY BASED ON APPLICATION.
- BOTTOM SIDE OF THE PCB IS CONTINUOUS GROUND PLANE.

- DENOTES PCB COPPER LAYOUT WITH SMOBC (SOLDER MASK OVER BARE COPPER)
- DENOTES COPPER LAND PATTERN FREE OF SOLDER MASK

UNLESS OTHERWISE SPECIFIED	INITIALS		DATE
DIMENSIONS ARE IN INCHES TOLERANCES ON: 2 PL DECIMALS ± 3 PL DECIMALS ± .005 ANGLES ± FRACTIONS ±	DRAWN	DK (RAVON)	08 MAR 05
	CHECKED	RZ (RAVON)	08 MAR 05
	APPROVED	HH (RAVON)	08 MAR 05

Mini-Circuits® 13 Neptune Avenue
Brooklyn NY 11235

PL, qp, DG983-1
TB-337 (75 Ω)

SIZE	CODE IDENT	DRAWING NO:	REV:
A	15542	98-PL-184	B
FILE:	98PL184	SCALE: 7:1	SHEET: 1 OF 1

Mini-Circuits®
THIS DOCUMENT AND ITS CONTENTS ARE THE PROPERTY OF MINI-CIRCUITS. EXCEPT FOR USE EXPRESSLY GRANTED, IN WRITING, TO ITS VENDORS, VENDEE AND THE UNITED STATES GOVERNMENT, MINI-CIRCUITS RESERVES ALL PROPRIETARY DESIGN, USE, MANUFACTURING AND REPRODUCTION RIGHTS THERETO. THESE CONTENTS SHALL NOT BE USED, DUPLICATED OR DISCLOSED TO ANY OUTSIDE PARTY, IN WHOLE OR IN PART, WITHOUT WRITTEN PERMISSION OF MINI-CIRCUITS.

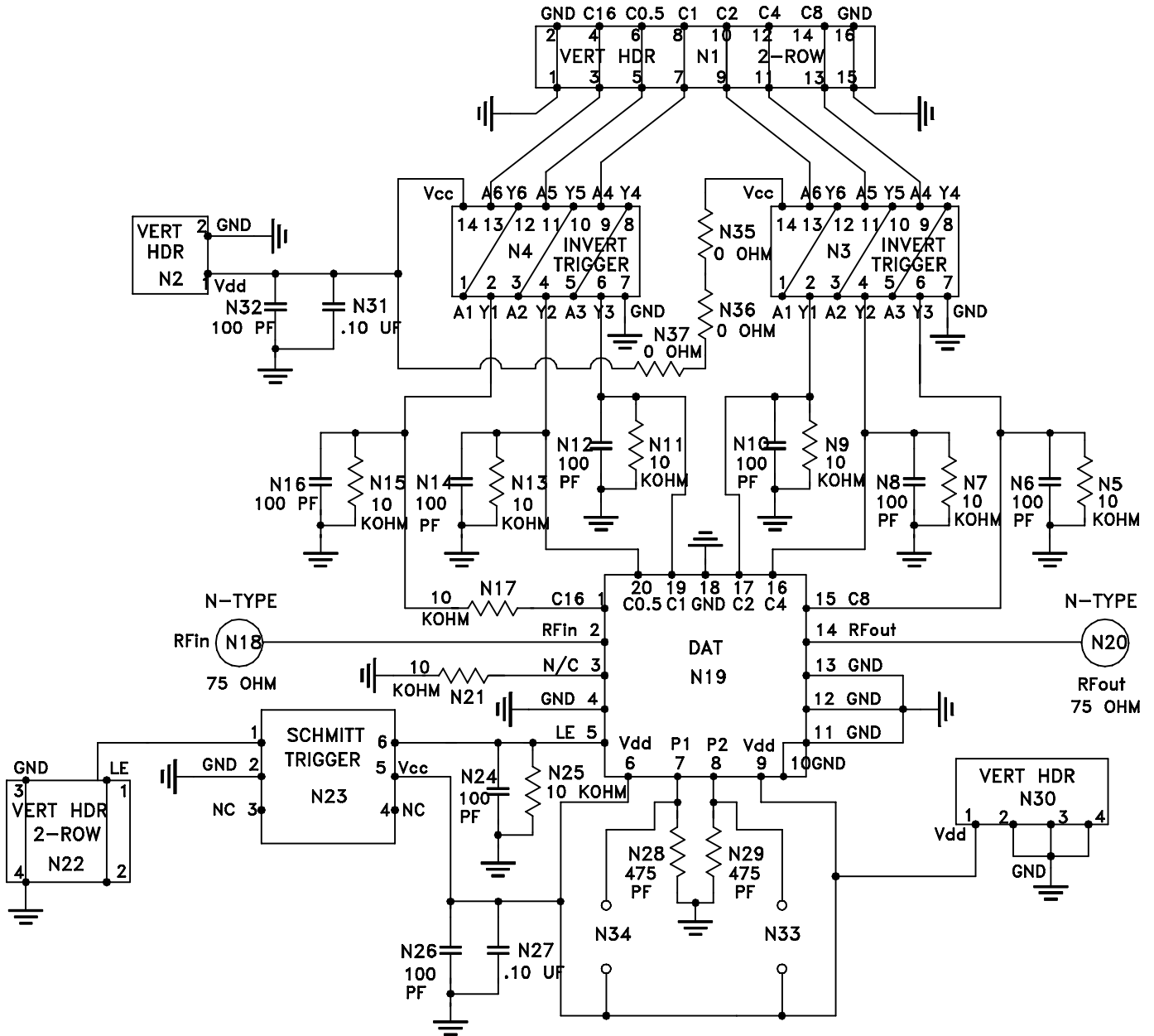

Schematic Diagram

All Mini-Circuits products are manufactured under exacting quality assurance and control standards, and are capable of meeting published specifications after being subjected to any or all of the following physical and environmental test.

Specification	Test/Inspection Condition	Reference/Spec
Operating Temperature	-40° to 85° C or -40° to 105° C Ambient Environment	Refer to Individual Model Data Sheet
Storage Temperature	-55° to 100° C or -65° to 150° C Ambient Environment	Refer to Individual Model Data Sheet
Temperature Humidity Bias	85°C, 85% RH, 96 hours	JESD22-A101B
Thermal Shock	-55° to 100°C, 100 cycles	MIL-STD-202, Method 107, Condition A-3, except +100°C
Solder Reflow Heat	Pb-Free Process: 260°C peak	J-STD-020, Table 4-1, 4-2 and 5-2; Figure 5-1
Solderability	10X magnification, 95% coverage	JESD22-B102, Method 1: Dip and Look Test
Marking Resistance to Solvents	Laser marked, visual observation	Mini-Circuits D4-Q4T0-04