

Directional Couplers

DBTC-7-152+

DBTC-7-152L+

50Ω, 7dB Coupling, 10 to 1500 MHz

Maximum Ratings

Operating Temperature	-40°C to 85°C
Storage Temperature	-55°C to 100°C

Permanent damage may occur if any of these limits are exceeded.

Pin Connections

INPUT	3
OUTPUT	4
COUPLED	1
GROUND	2
ISOLATE (DO NOT USE)	6

Outline Drawing / Dimensions (inch / mm)

AT790-1 (DBTC-7-152+)

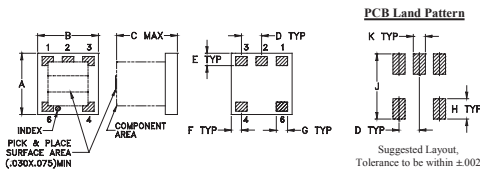

A	B	C	D	E	F	G	H	J	K	wt
.150	.150	.150	.050	.030	.025	.028	.050	.160	.030	grams
3.81	3.81	3.81	1.27	0.76	0.64	0.71	1.27	4.06	0.76	0.10

AT1030 (DBTC-7-152L+)

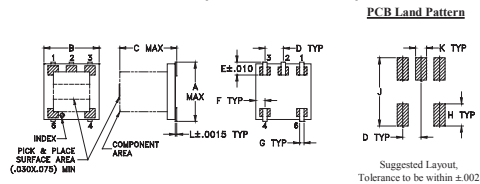

A	B	C	D	E	F	G	H	J	K	L	wt
.166	.150	.155	.050	.037	.025	.012	.060	.184	.030	.004	grams
4.22	3.81	3.94	1.27	0.94	0.64	0.30	1.52	4.67	0.76	0.10	0.10

Demo Board MCL P/N: TB-278

Suggested PCB Layout (PL-150)

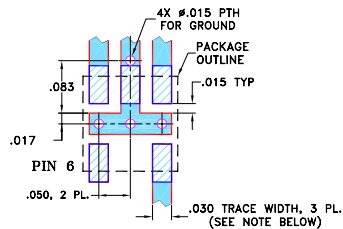

- NOTES:
- TRACE WIDTH IS SHOWN FOR ROGERS RO4350B WITH DIELECTRIC THICKNESS 0.030" ± 0.002"; COPPER: 1/2 OZ. EACH SIDE. FOR OTHER MATERIALS TRACE WIDTH MAY NEED TO BE MODIFIED.
 - BOTTOM SIDE OF THE PCB IS CONTINUOUS GROUND PLANE.
- DENOTES PCB COPPER LAYOUT WITH SMOBC (SOLDER MASK OVER BARE COPPER)
 - DENOTES COPPER LAND PATTERN FREE OF SOLDER MASK

Notes

- Performance and quality attributes and conditions not expressly stated in this specification document are intended to be excluded and do not form a part of this specification document.
- Electrical specifications and performance data contained in this specification document are based on Mini-Circuit's applicable established test performance criteria and measurement instructions.
- The parts covered by this specification document are subject to Mini-Circuits standard limited warranty and terms and conditions (collectively, "Standard Terms"); Purchasers of this part are entitled to the rights and benefits contained therein. For a full statement of the Standard Terms and the exclusive rights and remedies thereunder, please visit Mini-Circuits' website at www.minicircuits.com/MCLStore/terms.jsp

Features

- very flat coupling
- very broadband, multi octave
- temperature stable, LTCC base
- all welded construction
- leads attached for better solderability
- micro miniature coupler
- aqueous washable
- protected by US Patents 6,140,887 & 6,784,521

Applications

- VHF/UHF transmitters
- cellular



No Leads

CASE STYLE:AT790-1

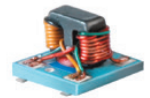

Leads

CASE STYLE:AT1030

+RoHS Compliant

The +Suffix identifies RoHS Compliance. See our web site for RoHS Compliance methodologies and qualifications

Electrical Specifications

FREQ. (MHz)	COUPLING (dB)		MAINLINE LOSS (dB)		DIRECTIVITY (dB)		VSWR (:1)	POWER INPUT (W)
	Nom.	Max. Flatness	Typ.	Max.	Typ.	Min.		
10-1500	7.0±0.5	±0.5						
10-100			2.2	2.7	32	20	1.4	0.5
100-750			2.2	2.6	29	15	1.4	1.0
750-1500			2.3	3.2	16	9	1.4	1.0

Typical Performance Data

Frequency (MHz)	Mainline Loss (dB) In-Out	Coupling (dB) In-Cpl	Directivity (dB)	Return Loss (dB)		
				In	Out	Cpl
5.00	2.17	7.07	27.17	12.45	21.18	21.33
50.00	2.12	6.92	33.24	13.24	21.93	26.08
150.00	2.15	6.97	32.95	13.44	21.26	25.04
300.00	2.17	6.98	29.37	13.82	19.97	23.43
500.00	2.16	6.91	24.56	14.71	18.49	22.88
700.00	2.18	6.84	20.96	15.84	17.26	24.92
1000.00	2.24	6.72	17.31	18.52	15.82	46.44
1200.00	2.33	6.69	15.48	21.27	15.02	24.76
1400.00	2.47	6.72	13.83	25.55	14.19	18.44
1500.00	2.57	6.76	13.09	28.03	13.74	16.40

DBTC-7-152+ MAINLINE LOSS

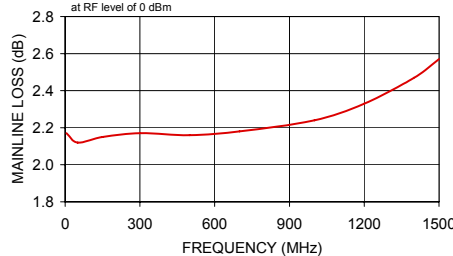

DBTC-7-152+ COUPLING & DIRECTIVITY

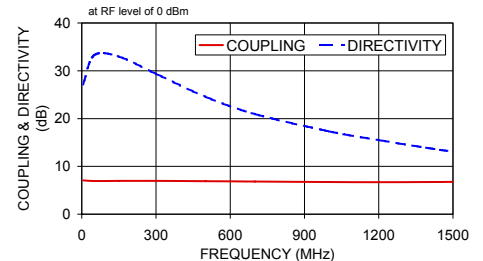

DBTC-7-152+ RETURN LOSS

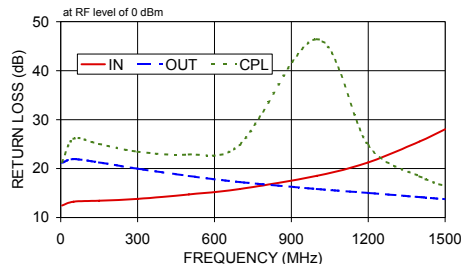

Electrical Schematic

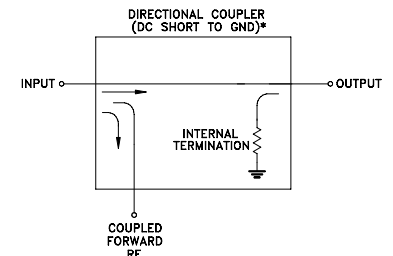

* ELECTRICAL SCHEMATIC IS FOR DIRECTIONAL COUPLER WITH INTERNAL TRANSFORMER(S) THAT ROUTES DC FROM RF PORTS TO GROUND.

Directional Coupler

DBTC-7-152L+

Typical Performance Data

TEST CONDITIONS: INPUT POWER =0 dBm @Temperature = +25°C

FREQUENCY (MHz)	INSERTION LOSS (dB)	COUPLING LOSS (dB)	DIRECTIVITY (dB)	RETURN LOSS (dB)		
				IN	OUT	CPL
10.0	2.08	6.85	36.06	13.19	22.11	25.94
20.0	2.09	6.86	35.81	13.24	22.17	26.44
50.0	2.11	6.88	34.64	13.31	22.11	26.58
100.0	2.12	6.90	31.88	13.44	21.79	26.08
150.0	2.13	6.90	29.32	13.59	21.47	25.61
200.0	2.12	6.90	27.12	13.75	21.21	25.18
250.0	2.12	6.90	25.31	13.91	20.95	24.81
300.0	2.12	6.89	23.74	14.10	20.70	24.53
350.0	2.12	6.88	22.45	14.27	20.53	24.29
400.0	2.11	6.86	21.30	14.47	20.37	24.08
450.0	2.11	6.85	20.25	14.69	20.22	23.96
500.0	2.11	6.84	19.36	14.93	20.06	23.89
550.0	2.11	6.82	18.53	15.17	19.94	23.85
600.0	2.11	6.81	17.78	15.44	19.84	23.77
650.0	2.12	6.79	17.12	15.74	19.72	23.72
700.0	2.12	6.78	16.47	16.02	19.66	23.69
750.0	2.12	6.77	15.89	16.32	19.63	23.62
800.0	2.14	6.76	15.36	16.62	19.59	23.45
850.0	2.15	6.74	14.88	16.92	19.53	23.23
900.0	2.17	6.74	14.41	17.20	19.53	22.97
950.0	2.19	6.73	13.98	17.48	19.52	22.61
1000.0	2.21	6.72	13.59	17.71	19.53	22.15
1050.0	2.24	6.71	13.22	17.90	19.56	21.63
1100.0	2.27	6.71	12.86	18.04	19.58	21.05
1150.0	2.31	6.71	12.55	18.08	19.54	20.42
1200.0	2.35	6.72	12.24	18.09	19.48	19.76
1250.0	2.40	6.72	11.94	18.00	19.43	19.11
1300.0	2.45	6.73	11.66	17.83	19.31	18.45
1350.0	2.51	6.74	11.38	17.58	19.15	17.80
1400.0	2.57	6.76	11.13	17.32	18.93	17.19
1450.0	2.63	6.78	10.88	16.97	18.72	16.60
1500.0	2.71	6.80	10.63	16.58	18.50	16.03
1550.0	2.79	6.83	10.39	16.17	18.20	15.49
1600.0	2.87	6.85	10.16	15.76	17.82	14.99
1700.0	3.07	6.93	9.71	14.89	17.04	14.04
1800.0	3.28	7.01	9.28	14.03	16.23	13.21
1900.0	3.53	7.11	8.85	13.22	15.31	12.46
2000.0	3.79	7.22	8.46	12.45	14.45	11.82
2100.0	4.08	7.36	8.08	11.78	13.58	11.24
2200.0	4.39	7.50	7.71	11.14	12.73	10.74
2300.0	4.71	7.67	7.33	10.57	12.03	10.29
2400.0	5.02	7.86	6.94	10.08	11.39	9.90
2500.0	5.33	8.07	6.55	9.69	10.83	9.54
2750.0	5.97	8.74	5.44	8.91	9.91	8.86
3000.0	6.39	9.70	4.02	8.43	9.87	8.46
3250.0	6.74	11.11	2.10	8.02	10.99	8.29
3500.0	7.38	13.24	0.46	7.44	14.30	8.25
3750.0	8.74	15.99	3.28	6.78	18.16	7.91
4000.0	10.92	18.01	4.96	6.23	13.74	7.23
4250.0	13.56	18.20	4.56	5.86	9.98	6.39
4500.0	16.17	17.67	3.41	5.62	7.93	5.67
4750.0	18.21	17.16	2.34	5.39	6.78	5.20
5000.0	19.47	16.94	1.66	5.17	6.16	4.85



Directional Coupler

DBTC-7-152L+

Typical Performance Data

TEST CONDITIONS: INPUT POWER =0 dBm @Temperature = -40°C

FREQUENCY (MHz)	INSERTION LOSS (dB)	COUPLING LOSS (dB)	DIRECTIVITY (dB)	RETURN LOSS (dB)		
				IN	OUT	CPL
10.0	2.09	6.85	33.06	12.83	20.48	20.13
20.0	2.00	6.70	38.20	13.43	20.58	21.81
50.0	1.96	6.62	39.16	13.80	20.24	22.32
100.0	1.96	6.62	33.47	14.09	20.15	22.35
150.0	1.96	6.62	30.28	14.30	20.24	22.54
200.0	1.97	6.62	27.94	14.32	19.92	22.32
250.0	1.97	6.63	25.99	14.47	19.89	22.54
300.0	1.98	6.63	24.26	14.57	19.79	22.49
350.0	1.98	6.62	22.86	14.68	19.65	22.54
400.0	1.98	6.61	21.64	14.87	19.63	22.64
450.0	1.98	6.60	20.59	15.06	19.53	22.63
500.0	1.98	6.59	19.69	15.29	19.46	22.83
550.0	1.98	6.58	18.85	15.48	19.35	22.92
600.0	1.98	6.56	18.08	15.73	19.25	23.04
650.0	1.98	6.54	17.40	16.06	19.29	23.15
700.0	1.98	6.53	16.75	16.33	19.29	23.27
750.0	1.99	6.51	16.17	16.63	19.24	23.47
800.0	2.00	6.49	15.65	16.92	19.20	23.53
850.0	2.01	6.48	15.15	17.24	19.12	23.67
900.0	2.03	6.46	14.66	17.54	19.14	23.65
950.0	2.04	6.44	14.21	17.87	19.19	23.52
1000.0	2.06	6.43	13.80	18.17	19.30	23.16
1050.0	2.08	6.42	13.41	18.35	19.34	22.55
1100.0	2.10	6.41	13.03	18.53	19.33	22.01
1150.0	2.14	6.40	12.69	18.58	19.35	21.28
1200.0	2.17	6.40	12.34	18.58	19.25	20.45
1250.0	2.21	6.39	12.02	18.61	19.21	19.70
1300.0	2.25	6.39	11.73	18.42	19.31	18.92
1350.0	2.30	6.39	11.45	18.11	19.08	18.15
1400.0	2.36	6.39	11.20	17.96	18.57	17.49
1450.0	2.42	6.40	10.95	17.75	18.12	16.87
1500.0	2.48	6.41	10.68	17.37	17.95	16.22
1550.0	2.55	6.43	10.41	16.71	18.02	15.58
1600.0	2.63	6.45	10.15	16.19	17.62	14.99
1700.0	2.81	6.49	9.68	15.29	16.64	13.92
1800.0	3.02	6.55	9.22	14.32	15.71	12.92
1900.0	3.26	6.62	8.80	13.41	14.83	12.13
2000.0	3.53	6.71	8.42	12.63	13.73	11.37
2100.0	3.81	6.82	8.02	11.82	12.95	10.73
2200.0	4.16	6.91	7.70	11.27	11.56	10.19
2300.0	4.46	7.08	7.28	10.48	11.23	9.67
2400.0	4.80	7.24	6.98	10.05	10.32	9.19
2500.0	5.11	7.42	6.63	9.67	9.73	8.88
2750.0	5.75	8.09	5.55	8.79	8.91	8.05
3000.0	6.13	9.10	4.10	8.15	8.83	7.50
3250.0	6.36	10.61	2.08	7.75	10.14	7.34
3500.0	6.93	13.05	0.77	7.13	13.40	7.26
3750.0	8.42	16.56	4.36	6.16	15.96	6.97
4000.0	10.82	19.16	6.52	5.59	11.66	6.37
4250.0	13.73	19.08	5.71	5.28	8.58	5.55
4500.0	16.38	18.23	4.12	5.12	7.07	4.89
4750.0	18.24	17.48	2.84	5.00	6.20	4.67
5000.0	19.19	17.20	2.01	4.82	5.79	4.31



Directional Coupler

DBTC-7-152L+

Typical Performance Data

TEST CONDITIONS: INPUT POWER =0 dBm @Temperature = +85°C

FREQUENCY (MHz)	INSERTION LOSS (dB)	COUPLING LOSS (dB)	DIRECTIVITY (dB)	RETURN LOSS (dB)		
				IN	OUT	CPL
10.0	2.34	7.22	31.92	12.29	25.59	31.28
20.0	2.35	7.22	31.92	12.37	25.72	33.68
50.0	2.37	7.24	31.64	12.50	25.64	34.54
100.0	2.37	7.26	30.20	12.62	24.85	32.74
150.0	2.37	7.26	28.25	12.74	23.65	30.05
200.0	2.35	7.25	26.27	12.98	23.08	28.94
250.0	2.33	7.24	24.56	13.18	22.59	27.97
300.0	2.32	7.23	23.08	13.39	21.97	27.09
350.0	2.31	7.22	21.86	13.62	21.61	26.62
400.0	2.30	7.21	20.76	13.87	21.30	26.07
450.0	2.29	7.20	19.80	14.13	20.92	25.65
500.0	2.28	7.19	18.97	14.41	20.57	25.37
550.0	2.27	7.18	18.22	14.69	20.31	25.08
600.0	2.26	7.17	17.54	15.01	20.08	24.79
650.0	2.26	7.16	16.95	15.35	19.86	24.57
700.0	2.26	7.15	16.39	15.68	19.71	24.32
750.0	2.26	7.14	15.89	16.02	19.62	24.04
800.0	2.27	7.14	15.45	16.36	19.58	23.68
850.0	2.28	7.14	15.03	16.67	19.49	23.27
900.0	2.30	7.14	14.63	16.95	19.43	22.86
950.0	2.32	7.14	14.26	17.22	19.39	22.40
1000.0	2.35	7.15	13.92	17.46	19.40	21.87
1050.0	2.38	7.15	13.61	17.66	19.45	21.32
1100.0	2.42	7.17	13.29	17.80	19.41	20.77
1150.0	2.46	7.18	13.02	17.89	19.36	20.19
1200.0	2.50	7.20	12.75	17.91	19.40	19.62
1250.0	2.55	7.21	12.48	17.82	19.35	19.04
1300.0	2.61	7.23	12.23	17.69	19.19	18.46
1350.0	2.66	7.25	11.97	17.53	19.11	17.93
1400.0	2.72	7.29	11.73	17.29	19.06	17.39
1450.0	2.79	7.32	11.50	16.95	18.92	16.87
1500.0	2.86	7.36	11.26	16.63	18.71	16.38
1550.0	2.94	7.39	11.03	16.27	18.47	15.90
1600.0	3.03	7.43	10.79	15.89	18.24	15.44
1700.0	3.20	7.54	10.33	15.06	17.77	14.51
1800.0	3.40	7.64	9.91	14.36	16.99	13.81
1900.0	3.62	7.76	9.49	13.68	16.24	13.20
2000.0	3.84	7.89	9.07	12.97	15.60	12.62
2100.0	4.09	8.04	8.68	12.36	14.88	12.01
2200.0	4.34	8.20	8.26	11.76	14.29	11.56
2300.0	4.60	8.36	7.85	11.23	13.50	11.13
2400.0	4.86	8.54	7.42	10.77	12.92	10.75
2500.0	5.11	8.73	6.99	10.36	12.46	10.37
2750.0	5.71	9.29	5.79	9.47	11.44	9.67
3000.0	6.18	9.98	4.47	8.98	11.02	9.30
3250.0	6.61	10.97	2.73	8.42	11.57	9.11
3500.0	7.16	12.43	0.56	7.75	14.09	9.16
3750.0	8.16	14.34	1.78	7.10	20.45	8.99
4000.0	9.89	16.06	3.53	6.39	18.29	8.27
4250.0	12.28	16.52	3.62	5.81	11.76	7.22
4500.0	15.10	16.22	2.80	5.40	8.53	6.27
4750.0	18.01	15.94	1.97	5.04	6.79	5.47
5000.0	20.48	15.84	1.40	4.75	5.80	4.92



REV. OR
DBTC-7-152L+
7/3/2012

Page 3 of 3

Directional Coupler

DBTC-7-152L+

Typical Performance Curves

Insertion Loss

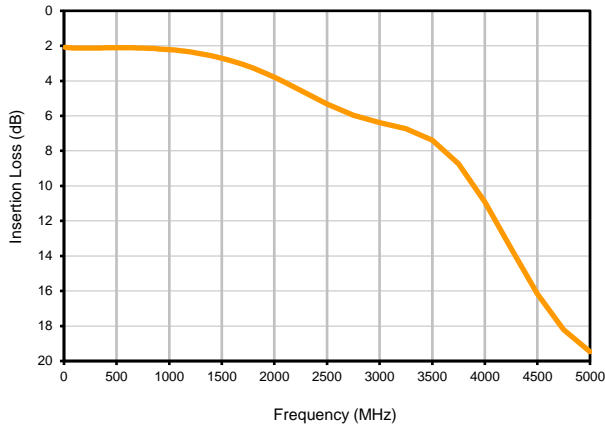

Insertion Loss vs. TEMPERATURE

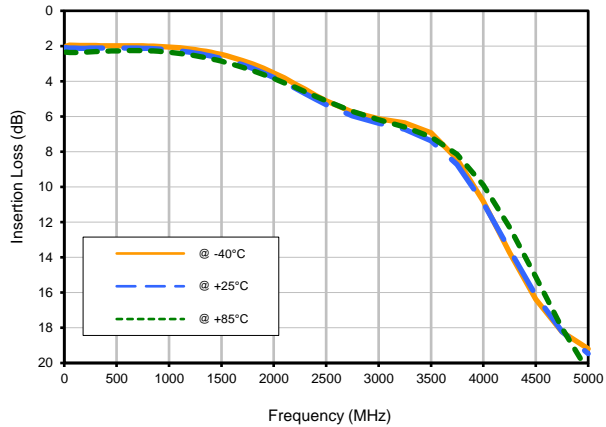

Coupling Loss vs. TEMPERATURE

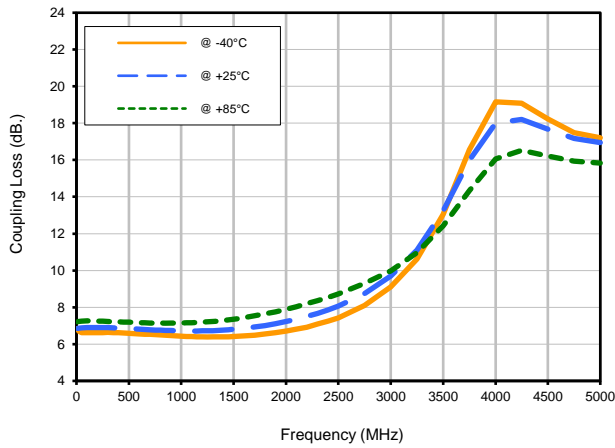

Directivity vs. TEMPERATURE

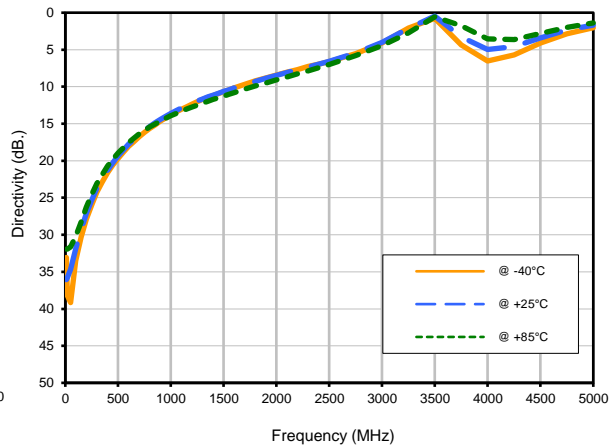

Directional Coupler

DBTC-7-152L+

Typical Performance Curves

Return Loss

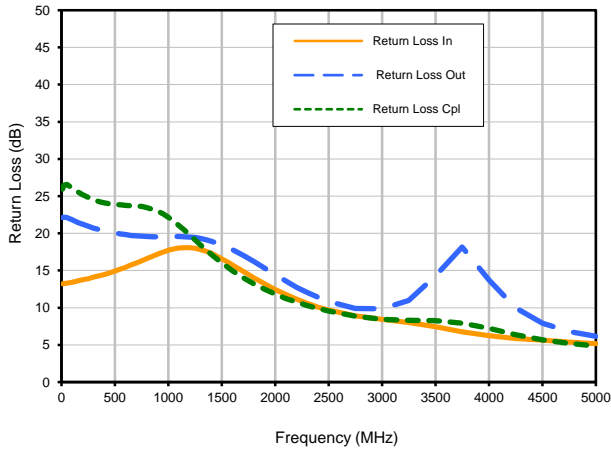

Return Loss In vs. TEMPERATURE

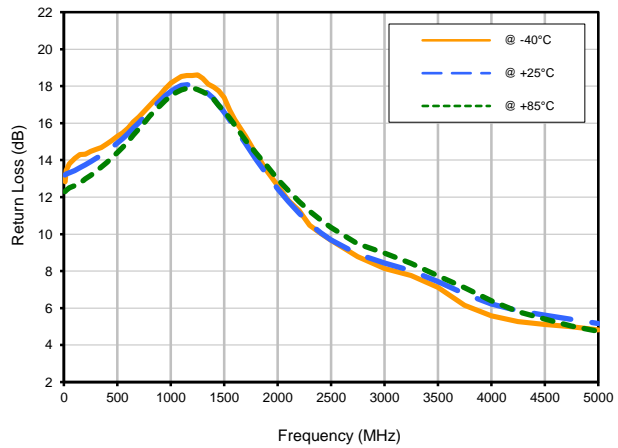

Return Loss Out vs. TEMPERATURE

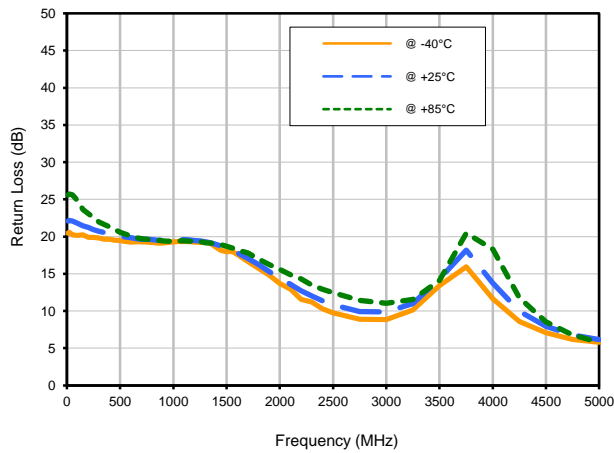

Return Loss Cpl vs. TEMPERATURE

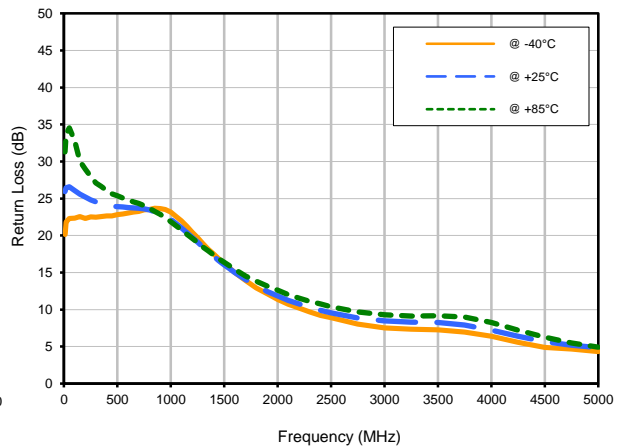

Outline Dimensions

AT1030

PCB Land Pattern

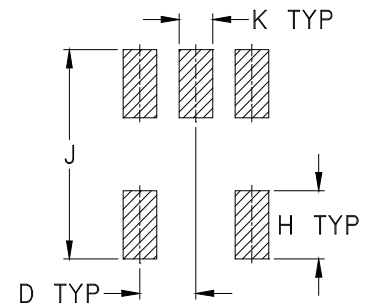
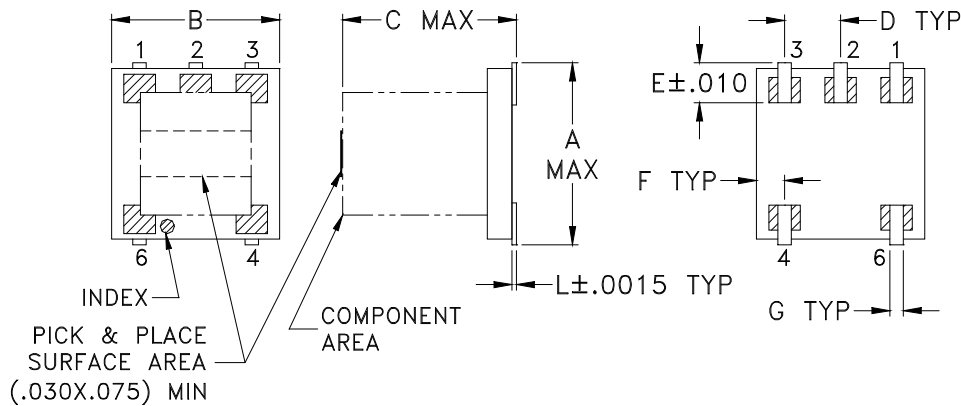

Suggested Layout,
Tolerance to be within $\pm .002$

CASE #	A	B	C	D	E	F	G	H	J	K	L	WT. GRAMS
AT1030	.166 (4.22)	.150 (3.81)	.155 (3.94)	.050 (1.27)	.037 (0.94)	.025 (0.64)	.012 (0.30)	.060 (1.52)	.184 (4.67)	.030 (0.76)	.004 (0.10)	.10

Dimensions are in inches (mm). Tolerances: 2 Pl. $\pm .01$; 3 Pl. $\pm .005$

Notes:

- Open style, ceramic base.
- Termination finish:
For RoHS Case Styles: Tin plate.
For RoHS-5 Case Styles: Tin-Lead plate.

Mini-Circuits[®]

Distribution Centers NORTH AMERICA 800-654-7949 • 417-335-5935 • Fax 417-335-5945 • EUROPE 44-1252-832600 • Fax 44-1252-837010

Mini-Circuits ISO 9001 & ISO 14001 Certified

INTERNET <http://www.minicircuits.com>

P.O. Box 350166, Brooklyn, New York 11235-0003 (718) 934-4500 Fax (718) 332-4661

Tape & Reel Packaging TR-F76

DEVICE ORIENTATION IN T&R

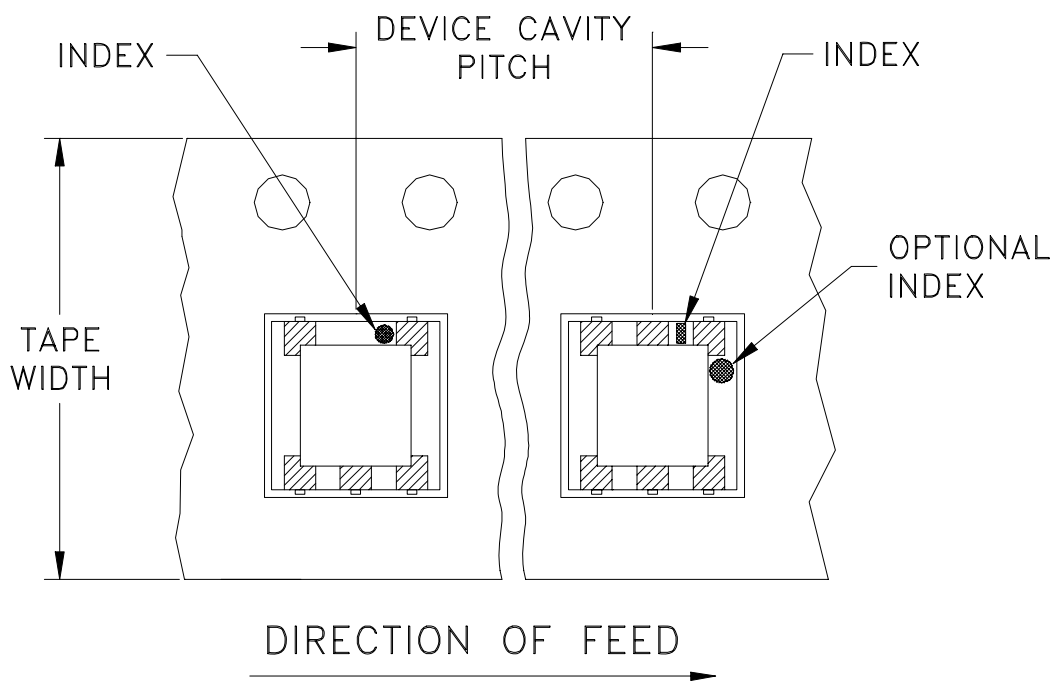

Tape Width, mm	Device Cavity Pitch, mm	Reel Size, inches	Devices per Reel
12	8	7	20
			50
			100
			200
			500
		13	1000
			2000

Note: Please consult individual model data sheet to determine device per reel availability.

Mini-Circuits carrier tape materials provide protection from ESD (Electro-Static Discharge) during handling and transportation. Tapes are static dissipative and comply with industry standards EIA-481/EIA-541.

Go to: www.minicircuits.com/pages/pdfs/tape.pdf



INTERNET <http://www.minicircuits.com>

P.O. Box 350166, Brooklyn, New York 11235-0003 (718) 934-4500 Fax (718) 332-4661

Distribution Centers NORTH AMERICA 800-654-7949 • 417-335-5935 • Fax 417-335-5945 • EUROPE 44-1252-832600 • Fax 44-1252-837010

Mini-Circuits ISO 9001 & ISO 14001 Certified

THIRD ANGLE PROJECTION

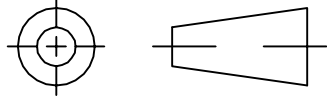

REVISIONS

REV	ECN No.	DESCRIPTION	DATE	DR	AUTH
OR	M90454	NEW RELEASE	01/16/04	AV	WP
A	M93049	AT1030 WAS AT1029	07/02/04	MMG	WP
B	M102713	ADDED "...WITH SMOBC"	01/17/06	MMG	IL

SUGGESTED MOUNTING CONFIGURATION FOR AT1030 CASE STYLE, "na" PIN CONNECTION

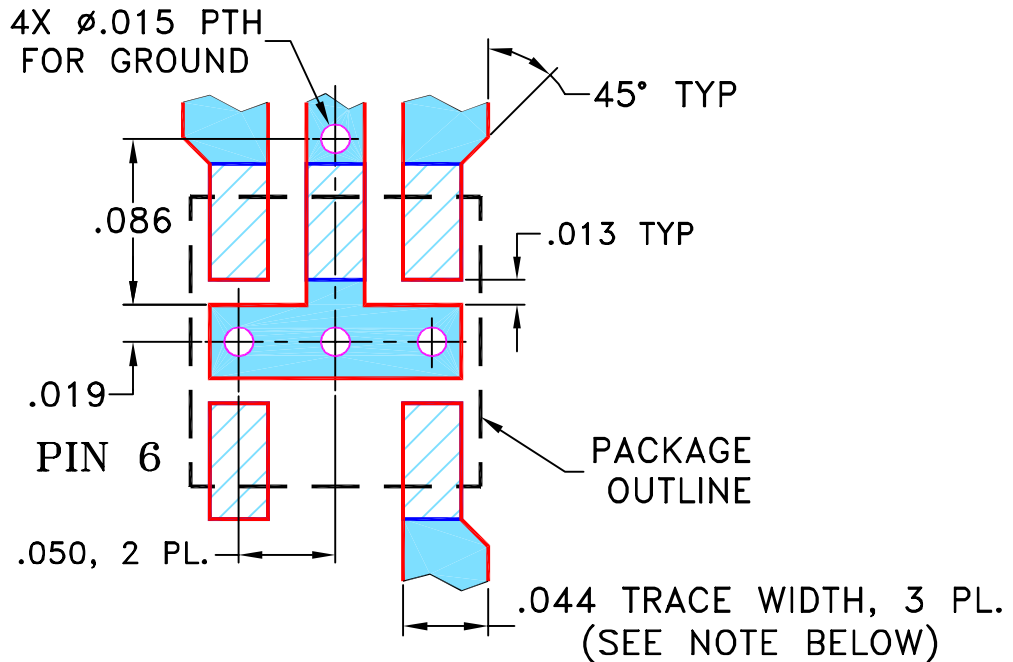

- NOTES: 1. TRACE WIDTH IS SHOWN FOR ROGERS R04350B WITH DIELECTRIC THICKNESS 0.020" ± 0.0015"; COPPER: 1/2 OZ. EACH SIDE. FOR OTHER MATERIALS TRACE WIDTH MAY NEED TO BE MODIFIED.
 2. BOTTOM SIDE OF THE PCB IS CONTINUOUS GROUND PLANE.



DENOTES PCB COPPER LAYOUT WITH SMOBC (SOLDER MASK OVER BARE COPPER)

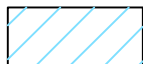

DENOTES COPPER LAND PATTERN FREE OF SOLDER MASK

UNLESS OTHERWISE SPECIFIED	INITIALS	DATE
DIMENSIONS ARE IN INCHES	DRAWN AV	01/08/04
TOLERANCES ON:	CHECKED IL	01/16/04
2 PL DECIMALS ±	APPROVED WP	01/16/04
3 PL DECIMALS ± .005		
ANGLES ±		
FRACTIONS ±		



Mini-Circuits®

13 Neptune Avenue
Brooklyn NY 11235

PL, na, AT1030, DBTC, TB-278

SIZE	CODE IDENT	DRAWING NO:	REV:
A	15542	98-PL-150	B
FILE:	98PL150	SCALE: 10:1	SHEET: 1 OF 1

Mini-Circuits®
 THIS DOCUMENT AND ITS CONTENTS ARE THE PROPERTY OF MINI-CIRCUITS. EXCEPT FOR USE EXPRESSLY GRANTED, IN WRITING, TO ITS VENDORS, VENDEE AND THE UNITED STATES GOVERNMENT, MINI-CIRCUITS RESERVES ALL PROPRIETARY DESIGN, USE, MANUFACTURING AND REPRODUCTION RIGHTS THERETO. THESE CONTENTS SHALL NOT BE USED, DUPLICATED OR DISCLOSED TO ANY OUTSIDE PARTY, IN WHOLE OR IN PART, WITHOUT WRITTEN PERMISSION OF MINI-CIRCUITS.

Evaluation Board and Circuit

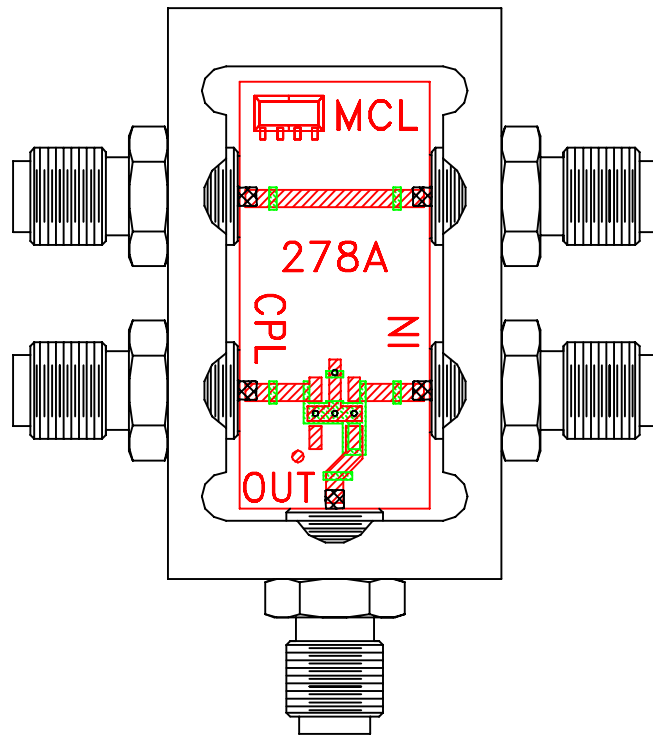

TB-278

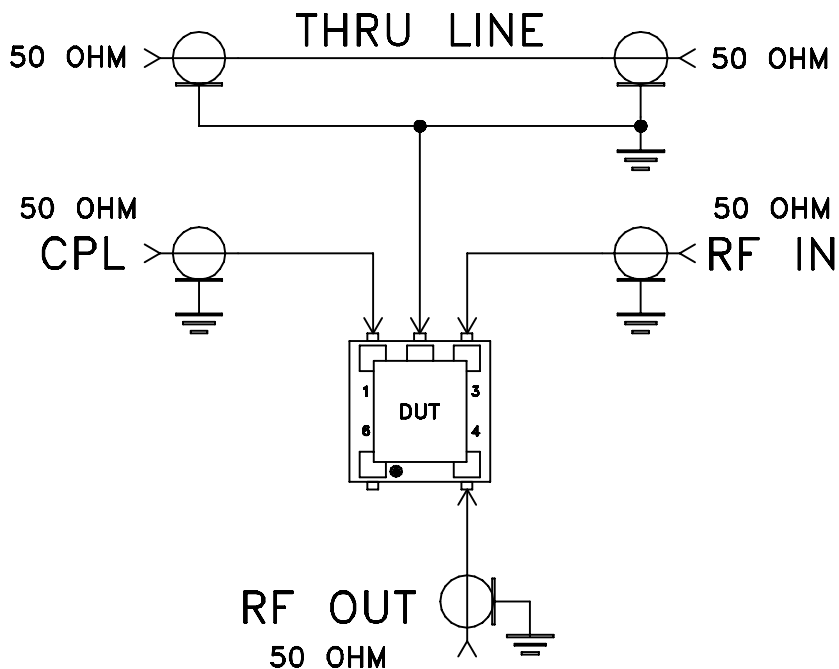

Schematic Diagram

Notes:

1. 50 Ohm SMA Female connectors.
2. PCB Material: Rogers R04350B or its equivalent, Dielectric Constant=3.5, Thickness=.020"

 Mini-Circuits®



All Mini-Circuits products are manufactured under exacting quality assurance and control standards, and are capable of meeting published specifications after being subjected to any or all of the following physical and environmental test.

Specification	Test/Inspection Condition	Reference/Spec
Operating Temperature	-40° to 85°C Ambient Environment	Individual Model Data Sheet
Storage Temperature	-55° to 100° C Ambient Environment	Individual Model Data Sheet
Humidity	90 to 95% RH, 240 hours, 50°C	MIL-STD-202, Method 103, Condition A, Except 50°C and end-point electrical test done within 12 hours
Thermal Shock	-55° to 100°C, 100 cycles	MIL-STD-202, Method 107, Condition A-3, except +100°C
Solder Reflow Heat	Sn-Pb Eutetic Process: 225°C peak Pb-Free Process 245° - 250°C peak	J-STD-020, Table 4-1, 4-2 and 5-2, Figure 5-1
Solderability	10X Magnification	J-STD-002, 95% Coverage
Vibration (High Frequency)	20g peak, 10-2000 Hz, 12 times in each of three perpendicular directions (total 36)	MIL-STD-202, Method 204, Condition D
Mechanical Shock	50g, 11 ms, 1/2-sine, 18 shocks: 3 each direction, each of 3 axes	MIL-STD-202, Method 213, Condition A
Marking Resistance to Solvents	Isopropyl alcohol + mineral spirits at 25°C; terpene defluxer at 25°C; distilled water + proylene glycol monomethyl ether + monoethanolamine at 63°C to 70°C	MIL-STD-202, Method 215