

Surface Mount

# Monolithic Amplifier

DC-7 GHz

## Features

- Miniature SOT-89 Package
- Frequency range, DC to 7 GHz
- Internally Matched to 50 Ohms
- Output power, 10.6 dBm typ.
- Excellent package for heat dissipation, exposed metal bottom
- Aqueous washable
- Protected by US Patent 6,943,629

## Applications

- Cellular
- PCS
- Communication receivers & transmitters



Generic photo used for illustration purposes only

## Gali 19+

CASE STYLE: DF782

**+RoHS Compliant**

The +Suffix identifies RoHS Compliance. See our web site for RoHS Compliance methodologies and qualifications

## General Description

Gali 19+ (RoHS compliant) is a wideband amplifier offering high dynamic range. It has repeatable performance from lot to lot, and is enclosed in a SOT-89 package. It uses patented Transient Protected Darlington configuration and is fabricated using InGaP HBT technology. Expected MTTF is 3,000 years at 85°C case temperature. Gali 19+ is designed to be rugged for ESD and supply switch-on transients.

## simplified schematic and pin description



Function	Pin Number	Description
RF IN	1	RF input pin. This pin requires the use of an external DC blocking capacitor chosen for the frequency of operation.
RF-OUT and DC-IN	3	RF output and bias pin. DC voltage is present on this pin; therefore a DC blocking capacitor is necessary for proper operation. An RF choke is needed to feed DC bias without loss of RF signal due to the bias connection, as shown in "Recommended Application Circuit".
GND	2,4	Connections to ground. Use via holes as shown in "Suggested Layout for PCB Design" to reduce ground path inductance for best performance.

### Notes

- A. Performance and quality attributes and conditions not expressly stated in this specification document are intended to be excluded and do not form a part of this specification document.  
B. Electrical specifications and performance data contained in this specification document are based on Mini-Circuit's applicable established test performance criteria and measurement instructions.  
C. The parts covered by this specification document are subject to Mini-Circuits standard limited warranty and terms and conditions (collectively, "Standard Terms"); Purchasers of this part are entitled to the rights and benefits contained therein. For a full statement of the Standard Terms and the exclusive rights and remedies thereunder, please visit Mini-Circuits' website at [www.minicircuits.com/MCLStore/terms.jsp](http://www.minicircuits.com/MCLStore/terms.jsp)



**Electrical Specifications at 25°C and 40mA, unless noted**

Parameter		Min.	Typ.	Max.	Units
Frequency Range*		DC		7	GHz
Gain	f=0.1 GHz	—	12.1	—	dB
	f=1 GHz	—	11.7	—	
	f=2 GHz	9.6	11.6	—	
	f=3 GHz	—	10.7	—	
	f=4 GHz	—	10.8	—	
	f=5 GHz	—	10.1	—	
	f=7 GHz	—	11.0	—	
Input Return Loss	f= DC to 3 GHz		12.5		dB
	f= 3 to 7 GHz		11.5		
Output Return Loss	f= DC to 3 GHz		14		dB
	f= 3 to 7 GHz		8.0		
Output Power @ 1 dB compression	f=7 GHz	9.0	10.6	—	dBm
Output IP3	f=2 GHz		23.7		dBm
Noise Figure	f=2 GHz		6.5		dB
Recommended Device Operating Current			40		mA
Device Operating Voltage		3.2	3.6	4.0	V
Device Voltage Variation vs. Temperature at 40 mA			-2.6		mV/°C
Device Voltage Variation vs. Current at 25°C			9.4		mV/mA
Thermal Resistance, junction-to-case <sup>1</sup>			122		°C/W

\*Guaranteed specification DC-7 GHz. Low frequency cut off determined by external coupling capacitors.

**Absolute Maximum Ratings**

Parameter	Ratings
Operating Temperature*	-45°C to 85°C
Storage Temperature	-65°C to 150°C
Operating Current	55mA
Input Power	15dBm

Note: Permanent damage may occur if any of these limits are exceeded. These ratings are not intended for continuous normal operation.

<sup>1</sup>Case is defined as ground leads.

\*Based on typical case temperature rise 2°C above ambient.

**Notes**

- A. Performance and quality attributes and conditions not expressly stated in this specification document are intended to be excluded and do not form a part of this specification document.
- B. Electrical specifications and performance data contained in this specification document are based on Mini-Circuit's applicable established test performance criteria and measurement instructions.
- C. The parts covered by this specification document are subject to Mini-Circuits standard limited warranty and terms and conditions (collectively, "Standard Terms"); Purchasers of this part are entitled to the rights and benefits contained therein. For a full statement of the Standard Terms and the exclusive rights and remedies thereunder, please visit Mini-Circuits' website at [www.minicircuits.com/MCLStore/terms.jsp](http://www.minicircuits.com/MCLStore/terms.jsp)



Product Marking

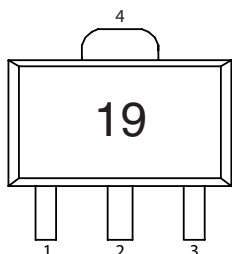

Markings in addition to model number designation may appear for internal quality control purposes.

Additional Detailed Technical Information

Additional information is available on our web site. To access this information enter the model number on our web site home page.

Performance data, graphs, s-parameter data set (.zip file)

Case Style: DF782

Plastic package, exposed paddle, lead finish: Matte-Tin

Tape & Reel: F55

7" reels with 20, 50, 100, 200, 500, 1K devices.

Suggested Layout for PCB Design: PL-019

Evaluation Board: TB-409-19+

Environmental Ratings: ENV08T2

Recommended Application Circuit

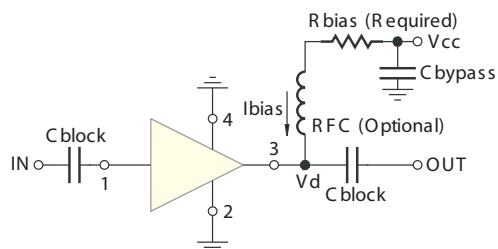

Test Board includes case, connectors, and components (in bold) soldered to PCB

R BIAS	
Vcc	"1%" Res. Values (ohms) for Optimum Biasing
7	88.7
8	113
9	137
10	162
11	187
12	215
13	237
14	261
15	287
16	309
17	332
18	357
19	383
20	412

Notes

- A. Performance and quality attributes and conditions not expressly stated in this specification document are intended to be excluded and do not form a part of this specification document.
- B. Electrical specifications and performance data contained in this specification document are based on Mini-Circuit's applicable established test performance criteria and measurement instructions.
- C. The parts covered by this specification document are subject to Mini-Circuits standard limited warranty and terms and conditions (collectively, "Standard Terms"); Purchasers of this part are entitled to the rights and benefits contained therein. For a full statement of the Standard Terms and the exclusive rights and remedies thereunder, please visit Mini-Circuits' website at [www.minicircuits.com/MCLStore/terms.jsp](http://www.minicircuits.com/MCLStore/terms.jsp)



**ESD Rating**

Human Body Model (HBM): Class 1A (250V to < 500V) in accordance with ANSI/ESD STM 5.1 - 2001

Machine Model (MM): Class M1 (< 100V) in accordance with ANSI/ESD STM 5.2 - 1999

**MSL Rating**

Moisture Sensitivity: MSL1 in accordance with IPC/JEDECJ-STD-020C

No.	Test Required	Condition	Standard	Quantity
1	Visual Inspection	Low Power Microscope Magnification 40x	MIP-IN-0003 (MCT spec)	45 units
2	Electrical Test	Room Temperature	SCD (MCL spec)	45 units
3	SAM Analysis	Less than 10% growth in term of delamination	J-Std-020C (Jedec Standard)	45 units
4	Moisture Sensitivity Level 1	Bake at 125°C for 24 hours Soak at 85°C/85%RH for 168 hours Reflow 3 cycles at 260°C peak	J-Std-020C (Jedec Standard)	45 units

**MSL Test Flow Chart**



**Notes**

- A. Performance and quality attributes and conditions not expressly stated in this specification document are intended to be excluded and do not form a part of this specification document.
- B. Electrical specifications and performance data contained in this specification document are based on Mini-Circuit's applicable established test performance criteria and measurement instructions.
- C. The parts covered by this specification document are subject to Mini-Circuits standard limited warranty and terms and conditions (collectively, "Standard Terms"); Purchasers of this part are entitled to the rights and benefits contained therein. For a full statement of the Standard Terms and the exclusive rights and remedies thereunder, please visit Mini-Circuits' website at [www.minicircuits.com/MCLStore/terms.jsp](http://www.minicircuits.com/MCLStore/terms.jsp)



# MMIC Amplifier

# GALI-19+

## Typical Performance Data

**NOTE: Use PDF Bookmarks to view DATA at required conditions  
or to view GRAPHS.**

**Definitions:**

Input Return Loss = -S11 (dB)

Gain(Power Gain) = S21 (dB)

Reverse Isolation = -S12 (dB)

Output Return Loss = -S22 (dB)

TEST CONDITIONS: Icc = 40mA, Vd = 3.64V @Temperature = +25degC

FREQ	Gain	Isolation	Input Return Loss	Output Return Loss	Stability		IP3 Output	1dB Comp. Output	Noise Figure
					K	Delta			
(MHz)	(dB)	(dB)	(dB)	(dB)	K	Delta	(dBm)	(dBm)	(dB)
50	12.34	17.02	32.79	31.60	1.15	0.58	26.76	11.59	4.09
100	12.31	17.08	33.28	31.38	1.15	0.58	26.63	11.32	4.25
200	12.28	17.11	32.78	31.53	1.16	0.57	26.80	11.78	4.17
300	12.25	17.13	32.66	31.51	1.16	0.57	26.64	11.31	4.22
400	12.21	17.13	32.05	31.47	1.16	0.57	26.18	11.71	4.20
500	12.17	17.15	31.57	31.03	1.17	0.56	26.07	11.53	4.22
600	12.13	17.15	30.85	30.71	1.17	0.56	25.94	11.73	4.18
700	12.10	17.17	30.31	30.54	1.17	0.56	26.16	11.60	4.21
800	12.05	17.19	29.75	30.52	1.18	0.55	26.34	11.50	4.21
1000	11.97	17.23	28.53	30.60	1.19	0.55	26.19	11.09	4.20
1200	11.89	17.28	27.42	31.12	1.20	0.54	26.08	10.69	4.21
1400	11.79	17.35	26.27	31.56	1.21	0.53	25.80	10.87	4.21
1600	11.71	17.41	25.25	32.66	1.22	0.52	26.31	10.71	4.20
1800	11.62	17.48	24.15	34.85	1.23	0.51	26.79	11.14	4.15
2000	11.55	17.56	23.02	39.20	1.24	0.50	26.50	11.48	4.18
2200	11.46	17.66	22.03	49.53	1.26	0.49	26.54	11.60	4.14
2400	11.38	17.74	21.02	42.18	1.27	0.48	26.72	11.59	4.24
2600	11.28	17.86	20.21	34.63	1.29	0.47	26.81	11.41	4.22
2800	11.19	17.99	19.42	30.75	1.31	0.46	26.63	11.12	4.24
3000	11.10	18.09	18.40	27.62	1.33	0.45	26.83	10.95	4.18
3200	11.02	18.22	17.70	25.11	1.35	0.44	27.25	10.91	4.25
3400	10.94	18.35	16.99	23.44	1.37	0.43	27.21	10.86	4.30
3600	10.87	18.48	16.34	21.87	1.38	0.43	26.70	10.53	4.38
3800	10.79	18.59	15.85	20.73	1.40	0.42	26.26	10.53	4.43
4000	10.74	18.74	15.46	19.52	1.42	0.42	26.19	10.92	4.47
4200	10.67	18.81	15.21	18.87	1.44	0.41	26.31	11.15	4.46
4400	10.63	18.95	15.05	18.22	1.46	0.41	26.27	11.04	4.49
4600	10.60	19.06	14.86	17.60	1.47	0.40	25.81	10.96	4.62
4800	10.60	19.16	14.74	17.10	1.48	0.40	25.60	11.07	4.63
5000	10.58	19.24	15.02	16.79	1.50	0.39	25.55	11.18	4.54
5200	10.58	19.28	15.26	16.54	1.50	0.39	26.05	10.94	4.62
5400	10.64	19.35	15.43	16.43	1.50	0.39	26.02	10.88	4.61
5600	10.68	19.33	16.03	16.45	1.50	0.39	25.93	10.66	4.69
5800	10.78	19.38	16.58	16.25	1.49	0.39	25.87	11.06	4.71
6000	10.87	19.40	17.38	16.20	1.48	0.39	25.72	11.26	4.71
6200	11.00	19.32	18.60	16.07	1.46	0.40	25.74	11.60	4.72
6400	11.11	19.30	19.85	15.97	1.44	0.40	25.74	11.96	4.76
6600	11.25	19.16	21.96	15.64	1.41	0.41	25.72	12.29	4.83
6800	11.41	19.06	23.45	15.11	1.38	0.43	25.50	12.31	4.80
7000	11.57	18.93	23.81	14.56	1.35	0.44	25.05	12.32	4.76

REV. X1  
GALI-19+  
070823

Page 1 of 11



IF/RF MICROWAVE COMPONENTS • ISO 9001 ISO 14001 AS 9100 CERTIFIED • RoHS compliant

P.O. Box 350166, Brooklyn, New York 11235-0003 (718) 934-4500 Fax (718) 332-4661



The Design Engineers Search Engine finds the model you need, Instantly • For detailed performance specs & shopping online see



# MMIC Amplifier

# GALI-19+

## Typical Performance Data

### Definitions:

Input Return Loss = -S11 (dB)

Gain(Power Gain) = S21 (dB)

Reverse Isolation = -S12 (dB)

Output Return Loss = -S22 (dB)

TEST CONDITIONS: Icc = 32mA, Vd = 3.56V @Temperature = +25degC

FREQ	Gain	Isolation	Input Return Loss	Output Return Loss	Stability		IP3 Output	1dB Comp. Output	Noise Figure
					K	Delta			
(MHz)	(dB)	(dB)	(dB)	(dB)	K	Delta	(dBm)	(dBm)	(dB)
50	12.01	16.82	26.80	47.52	1.16	0.57	21.73	7.67	4.06
100	11.97	16.84	26.99	52.26	1.16	0.57	21.67	7.59	4.16
200	11.95	16.87	26.73	54.27	1.16	0.57	21.79	8.07	4.14
300	11.93	16.89	26.71	57.12	1.17	0.56	21.63	7.51	4.19
400	11.88	16.89	26.57	52.20	1.17	0.56	21.32	7.97	4.20
500	11.84	16.90	26.42	54.40	1.17	0.56	21.23	7.70	4.18
600	11.79	16.93	26.15	52.01	1.18	0.55	21.11	8.04	4.17
700	11.77	16.94	25.87	48.32	1.18	0.55	21.31	7.74	4.19
800	11.72	16.95	25.59	47.99	1.18	0.55	21.48	7.68	4.19
1000	11.65	17.01	24.88	49.70	1.19	0.54	21.31	7.26	4.18
1200	11.58	17.05	24.25	47.20	1.20	0.53	21.15	6.83	4.17
1400	11.47	17.10	23.56	56.62	1.21	0.52	20.90	7.00	4.19
1600	11.39	17.18	22.72	58.14	1.23	0.51	21.32	6.95	4.19
1800	11.30	17.26	21.83	43.03	1.24	0.50	21.64	7.37	4.12
2000	11.24	17.34	20.88	38.44	1.25	0.50	21.45	7.79	4.12
2200	11.15	17.43	20.11	33.60	1.26	0.49	21.50	7.87	4.09
2400	11.07	17.53	19.20	30.53	1.28	0.48	21.71	8.04	4.20
2600	10.99	17.63	18.56	28.22	1.29	0.47	21.78	7.72	4.19
2800	10.89	17.76	17.87	25.85	1.31	0.46	21.70	7.45	4.19
3000	10.80	17.86	17.00	23.95	1.33	0.45	21.90	7.30	4.15
3200	10.75	18.00	16.38	22.57	1.34	0.44	22.28	7.17	4.20
3400	10.66	18.12	15.73	21.14	1.36	0.44	22.26	7.11	4.29
3600	10.59	18.24	15.20	19.98	1.38	0.43	21.73	6.84	4.33
3800	10.51	18.36	14.71	19.01	1.40	0.42	21.49	6.86	4.39
4000	10.48	18.53	14.34	18.20	1.42	0.42	21.56	7.38	4.41
4200	10.40	18.57	14.13	17.70	1.43	0.42	21.92	7.66	4.39
4400	10.36	18.70	14.01	17.09	1.45	0.41	21.72	7.51	4.47
4600	10.35	18.82	13.81	16.61	1.46	0.41	21.32	7.43	4.57
4800	10.35	18.95	13.65	16.21	1.48	0.40	21.13	7.52	4.60
5000	10.33	18.99	13.93	15.97	1.48	0.40	21.26	7.64	4.51
5200	10.33	19.01	14.18	15.79	1.49	0.40	21.74	7.67	4.59
5400	10.40	19.11	14.26	15.69	1.49	0.40	21.72	7.20	4.56
5600	10.45	19.08	14.78	15.82	1.48	0.40	21.73	6.89	4.66
5800	10.56	19.13	15.23	15.70	1.48	0.40	21.86	7.52	4.64
6000	10.64	19.12	15.90	15.70	1.47	0.40	21.92	7.72	4.68
6200	10.78	19.06	16.88	15.63	1.45	0.41	22.03	8.26	4.65
6400	10.91	19.05	17.73	15.63	1.43	0.41	22.18	8.87	4.68
6600	11.04	18.89	19.32	15.40	1.40	0.42	22.35	9.39	4.73
6800	11.21	18.77	20.45	14.95	1.37	0.43	22.35	9.56	4.71
7000	11.37	18.67	20.92	14.48	1.34	0.45	22.09	9.68	4.71

REV. X1  
GALI-19+  
070823

Page 2 of 11



IF/RF MICROWAVE COMPONENTS • ISO 9001 ISO 14001 AS 9100 CERTIFIED • RoHS compliant

P.O. Box 350166, Brooklyn, New York 11235-0003 (718) 934-4500 Fax (718) 332-4661



The Design Engineers Search Engine finds the model you need, Instantly • For detailed performance specs & shopping online see



# MMIC Amplifier

# GALI-19+

## Typical Performance Data

### Definitions:

Input Return Loss = -S11 (dB)

Gain(Power Gain) = S21 (dB)

Reverse Isolation = -S12 (dB)

Output Return Loss = -S22 (dB)

TEST CONDITIONS: Icc = 48mA, Vd = 3.71V @Temperature = +25degC

FREQ	Gain	Isolation	Input Return Loss	Output Return Loss	Stability		IP3 Output	1dB Comp. Output	Noise Figure
					K	Delta			
(MHz)	(dB)	(dB)	(dB)	(dB)	K	Delta	(dBm)	(dBm)	(dB)
50	12.51	17.22	39.58	27.83	1.15	0.58	30.10	13.90	4.16
100	12.48	17.21	41.24	27.73	1.15	0.58	30.12	13.80	4.31
200	12.45	17.24	39.89	27.68	1.15	0.58	30.47	13.89	4.21
300	12.41	17.24	38.36	27.68	1.16	0.57	30.16	13.77	4.27
400	12.38	17.26	36.62	27.58	1.16	0.57	29.66	13.96	4.25
500	12.35	17.27	35.57	27.54	1.16	0.57	29.31	13.83	4.28
600	12.31	17.28	34.38	27.42	1.17	0.56	29.19	13.96	4.22
700	12.26	17.30	33.47	27.26	1.17	0.56	29.49	13.88	4.26
800	12.22	17.31	32.31	27.19	1.17	0.56	29.69	13.76	4.23
1000	12.13	17.36	30.83	27.42	1.18	0.55	29.53	13.52	4.22
1200	12.05	17.41	29.23	27.51	1.19	0.54	29.51	13.17	4.25
1400	11.97	17.47	27.90	28.09	1.20	0.53	29.23	13.30	4.27
1600	11.87	17.54	26.65	28.80	1.22	0.52	29.92	13.25	4.24
1800	11.79	17.62	25.54	30.41	1.23	0.51	30.40	13.51	4.19
2000	11.70	17.69	24.29	32.47	1.24	0.50	30.17	13.76	4.22
2200	11.61	17.79	23.26	36.53	1.26	0.49	30.10	13.82	4.20
2400	11.52	17.88	22.14	46.02	1.27	0.48	30.24	13.86	4.30
2600	11.43	17.99	21.20	44.18	1.29	0.47	29.89	13.78	4.29
2800	11.34	18.13	20.35	35.06	1.31	0.46	29.78	13.53	4.30
3000	11.26	18.22	19.33	30.27	1.33	0.45	29.90	13.42	4.24
3200	11.16	18.35	18.54	27.16	1.35	0.44	29.89	13.28	4.32
3400	11.09	18.49	17.77	24.96	1.37	0.43	29.85	13.21	4.37
3600	11.01	18.60	17.11	23.06	1.39	0.43	29.04	12.99	4.43
3800	10.93	18.73	16.64	21.67	1.41	0.42	28.28	12.95	4.48
4000	10.86	18.88	16.17	20.37	1.43	0.41	27.98	13.16	4.51
4200	10.80	18.95	15.90	19.65	1.44	0.41	28.19	13.44	4.51
4400	10.75	19.09	15.76	18.86	1.46	0.40	28.29	13.37	4.56
4600	10.72	19.20	15.61	18.17	1.48	0.40	27.92	13.40	4.65
4800	10.71	19.33	15.47	17.64	1.50	0.39	27.72	13.51	4.69
5000	10.69	19.40	15.75	17.27	1.51	0.39	27.38	13.49	4.61
5200	10.70	19.43	16.07	16.98	1.51	0.39	27.56	13.35	4.69
5400	10.74	19.50	16.30	16.84	1.51	0.39	27.54	13.34	4.68
5600	10.77	19.50	16.98	16.87	1.51	0.38	27.29	13.09	4.74
5800	10.86	19.55	17.54	16.64	1.51	0.38	26.91	13.42	4.79
6000	10.96	19.56	18.44	16.56	1.50	0.39	26.37	13.33	4.79
6200	11.08	19.49	20.00	16.39	1.47	0.39	26.20	13.40	4.79
6400	11.19	19.49	21.51	16.27	1.46	0.39	25.99	13.59	4.83
6600	11.33	19.33	24.15	15.89	1.43	0.41	25.83	13.77	4.91
6800	11.50	19.22	26.27	15.32	1.39	0.42	25.53	13.69	4.88
7000	11.65	19.10	25.96	14.74	1.36	0.43	25.17	13.66	4.89

REV. X1  
GALI-19+  
070823

Page 3 of 11



IF/RF MICROWAVE COMPONENTS • ISO 9001 ISO 14001 AS 9100 CERTIFIED • RoHS compliant

P.O. Box 350166, Brooklyn, New York 11235-0003 (718) 934-4500 Fax (718) 332-4661



The Design Engineers Search Engine finds the model you need, Instantly • For detailed performance specs & shopping online see



# MMIC Amplifier

# GALI-19+

## Typical Performance Data

### Definitions:

Input Return Loss = -S11 (dB)

Gain(Power Gain) = S21 (dB)

Reverse Isolation = -S12 (dB)

Output Return Loss = -S22 (dB)

TEST CONDITIONS: Icc = 40mA, Vd = 3.82V @Temperature = -45degC

FREQ	Gain	Isolation	Input Return Loss	Output Return Loss	Stability		IP3 Output	1dB Comp. Output	Noise Figure
					K	Delta			
(MHz)	(dB)	(dB)	(dB)	(dB)	K	Delta	(dBm)	(dBm)	(dB)
50	12.30	17.01	29.17	37.35	1.15	0.58	27.35	11.21	3.65
100	12.26	16.99	28.24	41.42	1.15	0.58	27.28	10.97	3.79
200	12.25	17.03	26.86	46.66	1.15	0.58	27.45	11.39	3.70
300	12.22	17.04	28.74	36.84	1.16	0.57	27.40	11.03	3.75
400	12.20	17.05	30.37	33.33	1.16	0.57	27.02	11.50	3.68
500	12.16	17.06	30.11	33.46	1.16	0.57	26.91	11.24	3.66
600	12.12	17.06	29.56	33.34	1.16	0.57	26.70	11.51	3.64
700	12.08	17.07	29.00	32.50	1.17	0.56	27.01	11.34	3.63
800	12.05	17.10	28.00	33.57	1.17	0.56	27.22	11.23	3.65
1000	11.97	17.12	27.22	33.25	1.18	0.55	26.98	10.83	3.64
1200	11.90	17.18	26.85	32.82	1.19	0.54	26.88	10.49	3.62
1400	11.82	17.22	26.35	32.83	1.20	0.54	26.69	10.69	3.65
1600	11.73	17.28	25.13	36.19	1.21	0.53	27.19	10.52	3.62
1800	11.64	17.35	24.03	41.75	1.22	0.52	27.54	10.95	3.56
2000	11.57	17.43	22.87	40.82	1.23	0.51	27.45	11.29	3.57
2200	11.48	17.52	22.12	42.47	1.25	0.50	27.49	11.45	3.55
2400	11.41	17.61	21.04	42.30	1.26	0.49	27.68	11.48	3.62
2600	11.32	17.73	20.09	34.87	1.28	0.48	27.67	11.35	3.63
2800	11.22	17.83	19.22	30.38	1.29	0.47	27.53	11.05	3.61
3000	11.14	17.93	18.26	26.51	1.31	0.46	27.81	10.88	3.55
3200	11.07	18.07	17.81	24.47	1.33	0.45	28.24	10.78	3.64
3400	10.99	18.17	17.32	22.94	1.34	0.45	28.43	10.74	3.71
3600	10.92	18.29	16.85	21.82	1.36	0.44	27.80	10.48	3.69
3800	10.85	18.39	16.41	20.82	1.38	0.43	27.31	10.34	3.75
4000	10.80	18.55	16.16	19.98	1.40	0.42	27.06	10.70	3.80
4200	10.74	18.61	15.92	19.53	1.41	0.42	27.39	10.98	3.81
4400	10.68	18.71	15.88	18.83	1.43	0.41	27.42	10.90	3.83
4600	10.65	18.82	15.62	18.09	1.44	0.41	26.98	10.82	3.91
4800	10.64	18.95	15.24	17.13	1.45	0.41	26.70	10.98	3.89
5000	10.62	19.03	15.43	16.60	1.47	0.40	26.65	11.11	3.89
5200	10.60	19.06	15.36	16.08	1.47	0.40	27.01	10.99	3.98
5400	10.64	19.16	15.28	15.66	1.47	0.40	27.17	10.83	3.93
5600	10.67	19.14	15.54	15.60	1.47	0.40	27.33	10.65	3.99
5800	10.76	19.22	15.78	15.44	1.46	0.40	27.22	10.97	4.03
6000	10.86	19.22	16.86	15.95	1.46	0.40	27.09	10.99	4.04
6200	11.00	19.11	19.04	16.08	1.43	0.40	27.08	11.42	4.05
6400	11.12	19.10	21.03	16.15	1.42	0.41	27.13	11.99	4.08
6600	11.26	18.92	25.05	15.96	1.39	0.42	27.03	12.46	4.17
6800	11.44	18.84	29.01	15.66	1.36	0.43	27.02	12.58	4.11
7000	11.62	18.67	27.96	14.85	1.32	0.45	26.62	12.66	4.07

REV. X1  
GALI-19+  
070823

Page 4 of 11



IF/RF MICROWAVE COMPONENTS • ISO 9001 ISO 14001 AS 9100 CERTIFIED • RoHS compliant

P.O. Box 350166, Brooklyn, New York 11235-0003 (718) 934-4500 Fax (718) 332-4661



The Design Engineers Search Engine finds the model you need, Instantly • For detailed performance specs & shopping online see





## Typical Performance Data

### Definitions:

Input Return Loss = -S11 (dB)

Gain(Power Gain) = S21 (dB)

Reverse Isolation = -S12 (dB)

Output Return Loss = -S22 (dB)

TEST CONDITIONS: Icc = 32mA, Vd = 3.73V @Temperature = -45degC

FREQ	Gain	Isolation	Input Return Loss	Output Return Loss	Stability		IP3 Output	1dB Comp. Output	Noise Figure
					K	Delta			
(MHz)	(dB)	(dB)	(dB)	(dB)	K	Delta	(dBm)	(dBm)	(dB)
50	11.99	16.81	25.13	40.12	1.16	0.57	21.89	7.33	3.59
100	11.96	16.79	24.53	37.70	1.16	0.57	21.78	7.13	3.71
200	11.94	16.84	23.76	33.70	1.16	0.57	21.88	7.59	3.68
300	11.92	16.83	24.88	39.23	1.16	0.57	21.81	7.14	3.72
400	11.90	16.83	25.98	49.96	1.16	0.57	21.58	7.60	3.67
500	11.88	16.85	25.73	59.88	1.17	0.56	21.49	7.28	3.61
600	11.83	16.86	25.68	59.86	1.17	0.56	21.38	7.56	3.62
700	11.78	16.88	25.42	53.93	1.17	0.56	21.57	7.49	3.61
800	11.77	16.88	24.57	56.93	1.18	0.56	21.74	7.38	3.63
1000	11.67	16.93	24.21	51.56	1.19	0.55	21.52	6.97	3.61
1200	11.61	16.97	23.95	70.87	1.19	0.54	21.39	6.55	3.60
1400	11.53	17.02	23.71	56.69	1.20	0.53	21.22	6.83	3.60
1600	11.46	17.07	22.63	43.11	1.21	0.52	21.59	6.57	3.58
1800	11.37	17.15	21.90	37.88	1.22	0.51	21.85	7.03	3.51
2000	11.30	17.23	21.03	35.68	1.24	0.51	21.73	7.51	3.53
2200	11.20	17.34	20.39	34.44	1.25	0.50	21.83	7.64	3.51
2400	11.14	17.40	19.48	31.67	1.26	0.49	22.05	7.73	3.60
2600	11.05	17.51	18.63	28.18	1.28	0.48	22.01	7.58	3.57
2800	10.97	17.62	17.77	26.15	1.29	0.47	21.92	7.32	3.57
3000	10.88	17.74	16.98	23.63	1.31	0.46	22.13	7.03	3.51
3200	10.81	17.86	16.59	22.02	1.33	0.45	22.50	7.04	3.58
3400	10.75	17.95	16.09	20.94	1.34	0.45	22.58	6.96	3.67
3600	10.67	18.10	15.72	20.14	1.36	0.44	22.20	6.66	3.64
3800	10.60	18.19	15.30	19.42	1.37	0.43	21.79	6.41	3.73
4000	10.56	18.34	15.07	18.63	1.39	0.43	21.77	7.00	3.72
4200	10.51	18.38	14.86	18.24	1.40	0.42	22.20	7.32	3.76
4400	10.46	18.50	14.78	17.75	1.42	0.42	22.17	7.22	3.79
4600	10.41	18.63	14.59	17.15	1.44	0.41	21.74	7.15	3.88
4800	10.42	18.74	14.23	16.27	1.45	0.41	21.51	7.14	3.87
5000	10.41	18.81	14.34	15.87	1.45	0.41	21.61	7.44	3.86
5200	10.38	18.85	14.33	15.45	1.46	0.41	22.13	7.34	3.93
5400	10.43	18.95	14.24	15.11	1.46	0.41	22.10	7.23	3.91
5600	10.45	18.93	14.52	15.07	1.46	0.41	22.24	6.77	3.97
5800	10.55	18.99	14.68	14.96	1.45	0.41	22.40	7.14	3.97
6000	10.67	18.98	15.65	15.47	1.44	0.41	22.53	7.30	3.98
6200	10.80	18.88	17.54	15.70	1.43	0.41	22.70	7.74	3.97
6400	10.94	18.84	19.04	15.83	1.41	0.42	22.93	8.53	4.02
6600	11.10	18.67	21.71	15.77	1.37	0.43	22.98	9.20	4.10
6800	11.27	18.59	24.29	15.52	1.35	0.44	23.04	9.34	4.06
7000	11.45	18.44	24.92	14.81	1.31	0.46	22.79	9.55	4.01

## Typical Performance Data

### Definitions:

Input Return Loss = -S11 (dB)

Gain(Power Gain) = S21 (dB)

Reverse Isolation = -S12 (dB)

Output Return Loss = -S22 (dB)

TEST CONDITIONS: Icc = 48mA, Vd = 3.89V @Temperature = -45degC

FREQ	Gain	Isolation	Input Return Loss	Output Return Loss	Stability		IP3 Output	1dB Comp. Output	Noise Figure
					K	Delta			
(MHz)	(dB)	(dB)	(dB)	(dB)	K	Delta	(dBm)	(dBm)	(dB)
50	12.46	17.10	32.88	31.37	1.14	0.59	31.06	13.98	3.75
100	12.43	17.12	31.23	33.04	1.15	0.58	31.06	13.82	3.89
200	12.42	17.14	29.58	35.53	1.15	0.58	31.26	14.03	3.75
300	12.39	17.15	32.01	31.29	1.15	0.58	31.21	13.69	3.80
400	12.36	17.17	34.45	29.25	1.16	0.57	30.75	14.08	3.71
500	12.32	17.18	33.48	29.08	1.16	0.57	30.30	13.93	3.70
600	12.28	17.18	32.51	29.08	1.16	0.57	30.24	14.11	3.68
700	12.25	17.20	31.54	28.74	1.16	0.56	30.58	13.88	3.70
800	12.21	17.21	30.27	29.21	1.17	0.56	30.83	13.82	3.69
1000	12.13	17.25	29.19	29.22	1.18	0.55	30.70	13.44	3.67
1200	12.06	17.29	28.85	29.11	1.18	0.55	30.64	13.16	3.67
1400	11.97	17.35	27.99	28.98	1.19	0.54	30.37	13.29	3.69
1600	11.89	17.40	26.64	31.06	1.20	0.53	31.31	13.21	3.67
1800	11.80	17.48	25.37	33.74	1.22	0.52	31.69	13.56	3.58
2000	11.72	17.55	24.06	34.46	1.23	0.51	31.37	13.85	3.64
2200	11.63	17.66	23.15	36.34	1.25	0.50	31.58	13.92	3.59
2400	11.55	17.73	22.04	41.10	1.26	0.49	31.69	14.02	3.68
2600	11.46	17.83	21.07	42.15	1.27	0.48	31.32	13.89	3.68
2800	11.37	17.96	20.08	34.52	1.29	0.47	31.28	13.53	3.67
3000	11.28	18.06	19.10	28.83	1.31	0.46	31.55	13.44	3.62
3200	11.20	18.18	18.66	26.10	1.33	0.45	31.66	13.28	3.69
3400	11.13	18.28	18.10	24.34	1.34	0.44	32.07	13.30	3.75
3600	11.05	18.42	17.60	22.97	1.36	0.44	31.31	13.00	3.74
3800	10.97	18.53	17.13	21.82	1.38	0.43	30.34	12.93	3.80
4000	10.92	18.67	16.90	20.81	1.40	0.42	29.84	13.15	3.86
4200	10.86	18.73	16.68	20.29	1.41	0.42	30.14	13.46	3.89
4400	10.80	18.85	16.60	19.55	1.43	0.41	30.38	13.40	3.88
4600	10.76	18.97	16.36	18.68	1.45	0.41	30.06	13.36	3.96
4800	10.76	19.10	15.98	17.65	1.46	0.40	29.78	13.43	3.96
5000	10.73	19.16	16.15	17.07	1.47	0.40	29.67	13.60	3.95
5200	10.71	19.21	16.11	16.50	1.48	0.40	29.74	13.50	4.03
5400	10.74	19.32	16.01	16.04	1.49	0.40	29.71	13.46	4.01
5600	10.76	19.29	16.37	15.94	1.48	0.40	29.76	13.17	4.05
5800	10.85	19.36	16.59	15.74	1.48	0.40	29.41	13.48	4.11
6000	10.95	19.37	17.79	16.25	1.47	0.39	28.98	13.47	4.07
6200	11.08	19.27	20.24	16.34	1.45	0.40	28.66	13.71	4.13
6400	11.19	19.26	22.67	16.38	1.43	0.40	28.63	14.03	4.14
6600	11.33	19.09	27.93	16.17	1.40	0.41	28.39	14.30	4.26
6800	11.51	19.01	34.27	15.83	1.37	0.42	28.11	14.30	4.20
7000	11.69	18.85	28.59	14.99	1.33	0.44	27.63	14.29	4.16

# MMIC Amplifier

# GALI-19+

## Typical Performance Data

### Definitions:

Input Return Loss = -S11 (dB)

Gain(Power Gain) = S21 (dB)

Reverse Isolation = -S12 (dB)

Output Return Loss = -S22 (dB)

TEST CONDITIONS: Icc = 40mA, Vd = 3.48V @Temperature = +85degC

FREQ	Gain	Isolation	Input Return Loss	Output Return Loss	Stability		IP3 Output	1dB Comp. Output	Noise Figure
					K	Delta			
(MHz)	(dB)	(dB)	(dB)	(dB)	K	Delta	(dBm)	(dBm)	(dB)
50	12.25	17.08	34.53	30.54	1.16	0.57	26.45	11.86	4.56
100	12.23	17.06	37.04	28.80	1.16	0.57	26.44	11.66	4.74
200	12.20	17.10	42.57	27.44	1.16	0.57	26.71	12.02	4.68
300	12.16	17.09	36.99	28.42	1.16	0.57	26.49	11.62	4.77
400	12.12	17.11	32.62	30.61	1.17	0.56	25.98	12.01	4.71
500	12.10	17.12	30.83	31.06	1.17	0.56	25.70	11.70	4.73
600	12.05	17.14	30.27	30.79	1.17	0.56	25.59	12.04	4.70
700	12.01	17.16	29.61	30.68	1.18	0.55	25.79	11.80	4.75
800	11.96	17.17	28.78	31.74	1.18	0.55	25.97	11.68	4.72
1000	11.88	17.22	27.41	32.37	1.19	0.54	25.82	11.32	4.72
1200	11.78	17.28	26.46	33.39	1.20	0.53	25.69	10.93	4.74
1400	11.71	17.33	25.46	33.84	1.21	0.52	25.46	11.11	4.75
1600	11.61	17.40	24.62	35.01	1.23	0.51	26.01	11.04	4.76
1800	11.53	17.50	23.55	36.61	1.24	0.50	26.41	11.41	4.74
2000	11.44	17.57	22.56	41.60	1.25	0.49	26.18	11.68	4.72
2200	11.35	17.67	21.60	56.66	1.27	0.48	26.25	11.79	4.71
2400	11.27	17.77	20.69	39.00	1.29	0.47	26.35	11.91	4.79
2600	11.17	17.89	19.85	33.20	1.30	0.46	26.26	11.66	4.84
2800	11.09	18.01	19.05	29.56	1.32	0.45	26.19	11.31	4.82
3000	11.01	18.12	17.94	26.63	1.34	0.45	26.35	11.15	4.76
3200	10.91	18.27	16.98	24.08	1.36	0.44	26.59	11.02	4.84
3400	10.84	18.41	16.05	22.07	1.38	0.43	26.51	11.05	4.91
3600	10.76	18.55	15.26	20.55	1.40	0.42	25.84	10.69	4.98
3800	10.70	18.69	14.66	19.27	1.42	0.42	25.51	10.77	5.04
4000	10.62	18.84	14.30	18.30	1.44	0.41	25.24	11.19	5.07
4200	10.58	18.93	14.09	17.75	1.45	0.41	25.55	11.39	5.05
4400	10.55	19.06	14.11	17.48	1.47	0.40	25.56	11.24	5.13
4600	10.52	19.17	14.11	17.27	1.49	0.40	25.35	11.29	5.23
4800	10.54	19.31	14.13	17.06	1.50	0.39	25.01	11.36	5.28
5000	10.51	19.33	14.57	17.10	1.51	0.39	25.13	11.39	5.17
5200	10.51	19.36	14.79	17.16	1.52	0.39	25.44	11.13	5.28
5400	10.58	19.48	14.86	17.09	1.53	0.38	25.36	11.05	5.25
5600	10.61	19.49	15.38	17.24	1.53	0.38	25.26	10.90	5.33
5800	10.69	19.53	15.87	16.99	1.52	0.38	24.94	11.31	5.35
6000	10.77	19.54	16.34	16.74	1.51	0.38	24.59	11.33	5.36
6200	10.87	19.47	17.17	16.68	1.49	0.39	24.44	11.49	5.39
6400	10.97	19.52	17.61	16.38	1.49	0.39	24.33	11.79	5.39
6600	11.06	19.43	18.48	16.02	1.47	0.40	24.16	12.06	5.50
6800	11.22	19.28	19.20	15.16	1.43	0.41	23.83	11.98	5.45
7000	11.35	19.23	19.52	14.52	1.40	0.42	23.52	11.95	5.48

REV. X1  
GALI-19+  
070823

Page 7 of 11



IF/RF MICROWAVE COMPONENTS • ISO 9001 ISO 14001 AS 9100 CERTIFIED • RoHS compliant

P.O. Box 350166, Brooklyn, New York 11235-0003 (718) 934-4500 Fax (718) 332-4661



The Design Engineers Search Engine finds the model you need, Instantly • For detailed performance specs & shopping online see



# MMIC Amplifier

# GALI-19+

## Typical Performance Data

### Definitions:

Input Return Loss = -S11 (dB)

Gain(Power Gain) = S21 (dB)

Reverse Isolation = -S12 (dB)

Output Return Loss = -S22 (dB)

TEST CONDITIONS: Icc = 32mA, Vd = 3.40V @Temperature = +85degC

FREQ	Gain	Isolation	Input Return Loss	Output Return Loss	Stability		IP3 Output	1dB Comp. Output	Noise Figure
					K	Delta			
(MHz)	(dB)	(dB)	(dB)	(dB)	K	Delta	(dBm)	(dBm)	(dB)
50	11.89	16.75	27.12	43.76	1.16	0.57	21.79	8.07	4.51
100	11.88	16.76	28.37	41.02	1.16	0.57	21.74	8.10	4.69
200	11.86	16.82	30.41	37.16	1.17	0.57	21.95	8.46	4.65
300	11.81	16.83	28.66	40.16	1.17	0.56	21.75	7.95	4.71
400	11.77	16.86	26.60	48.53	1.17	0.56	21.34	8.45	4.70
500	11.72	16.88	25.63	54.19	1.18	0.55	21.19	8.13	4.71
600	11.70	16.90	25.65	48.09	1.18	0.55	21.06	8.49	4.67
700	11.66	16.91	25.29	45.91	1.19	0.55	21.28	8.29	4.71
800	11.60	16.92	24.54	46.03	1.19	0.54	21.43	8.11	4.71
1000	11.53	16.97	23.91	46.12	1.20	0.53	21.21	7.57	4.70
1200	11.44	17.02	23.18	43.65	1.21	0.53	21.09	7.26	4.71
1400	11.35	17.09	22.52	44.73	1.22	0.52	20.88	7.48	4.74
1600	11.27	17.17	21.95	42.64	1.23	0.51	21.31	7.57	4.72
1800	11.20	17.25	21.26	40.18	1.25	0.50	21.63	7.84	4.68
2000	11.13	17.31	20.52	35.35	1.26	0.49	21.44	8.33	4.68
2200	11.03	17.43	19.66	32.32	1.27	0.48	21.53	8.48	4.68
2400	10.96	17.52	18.94	28.98	1.29	0.47	21.71	8.42	4.77
2600	10.85	17.64	18.10	26.60	1.31	0.46	21.62	8.25	4.78
2800	10.76	17.77	17.38	25.00	1.32	0.45	21.56	7.90	4.78
3000	10.69	17.90	16.52	23.24	1.34	0.44	21.78	7.65	4.68
3200	10.60	18.03	15.64	21.35	1.36	0.44	22.07	7.50	4.75
3400	10.52	18.18	14.80	20.03	1.38	0.43	21.96	7.62	4.89
3600	10.44	18.32	14.10	18.83	1.40	0.42	21.50	7.31	4.94
3800	10.39	18.46	13.63	17.87	1.41	0.42	21.27	7.23	5.01
4000	10.33	18.60	13.29	17.02	1.43	0.42	21.36	7.95	5.02
4200	10.28	18.70	13.05	16.57	1.45	0.41	21.70	8.15	4.98
4400	10.24	18.82	13.05	16.42	1.47	0.41	21.49	7.91	5.09
4600	10.24	18.91	13.14	16.26	1.48	0.40	21.12	7.98	5.19
4800	10.27	19.04	13.17	16.13	1.49	0.40	21.02	8.04	5.25
5000	10.23	19.07	13.45	16.24	1.50	0.39	21.23	8.08	5.14
5200	10.23	19.11	13.65	16.31	1.51	0.39	21.70	7.78	5.20
5400	10.32	19.22	13.75	16.28	1.51	0.39	21.65	7.67	5.20
5600	10.36	19.21	14.23	16.43	1.51	0.39	21.68	7.48	5.29
5800	10.45	19.24	14.58	16.28	1.51	0.39	21.78	8.14	5.29
6000	10.53	19.26	14.93	16.09	1.50	0.39	21.82	8.30	5.30
6200	10.63	19.18	15.66	16.11	1.48	0.40	22.01	8.85	5.30
6400	10.75	19.20	16.04	15.91	1.47	0.40	22.15	9.36	5.30
6600	10.81	19.14	16.55	15.66	1.45	0.41	22.31	9.80	5.41
6800	10.97	18.99	17.12	14.92	1.42	0.42	22.21	9.77	5.39
7000	11.10	18.93	17.57	14.38	1.39	0.43	22.12	9.93	5.40

REV. X1  
GALI-19+  
070823

Page 8 of 11



IF/RF MICROWAVE COMPONENTS • ISO 9001 ISO 14001 AS 9100 CERTIFIED • RoHS compliant

P.O. Box 350166, Brooklyn, New York 11235-0003 (718) 934-4500 Fax (718) 332-4661



The Design Engineers Search Engine finds the model you need, Instantly • For detailed performance specs & shopping online see



## Typical Performance Data

### Definitions:

Input Return Loss = -S11 (dB)

Gain(Power Gain) = S21 (dB)

Reverse Isolation = -S12 (dB)

Output Return Loss = -S22 (dB)

TEST CONDITIONS: Icc = 48mA, Vd = 3.55V @Temperature = +85degC

FREQ	Gain	Isolation	Input Return Loss	Output Return Loss	Stability		IP3 Output	1dB Comp. Output	Noise Figure
					K	Delta			
(MHz)	(dB)	(dB)	(dB)	(dB)	K	Delta	(dBm)	(dBm)	(dB)
50	12.46	17.21	44.11	26.80	1.15	0.58	29.89	13.77	4.63
100	12.42	17.19	55.95	25.81	1.15	0.58	30.01	13.73	4.82
200	12.39	17.24	42.25	24.62	1.16	0.57	30.27	13.77	4.71
300	12.35	17.24	40.74	25.31	1.16	0.57	29.94	13.73	4.83
400	12.32	17.26	36.60	26.73	1.16	0.57	29.30	13.80	4.74
500	12.28	17.27	34.37	27.28	1.17	0.56	28.86	13.72	4.81
600	12.24	17.28	33.76	27.16	1.17	0.56	28.76	13.84	4.73
700	12.19	17.30	32.78	27.24	1.18	0.55	28.93	13.75	4.80
800	12.15	17.31	31.46	27.75	1.18	0.55	29.09	13.67	4.74
1000	12.06	17.36	29.88	28.47	1.19	0.54	28.82	13.48	4.75
1200	11.97	17.42	28.47	28.74	1.20	0.53	28.74	13.20	4.80
1400	11.89	17.48	27.32	29.19	1.21	0.53	28.44	13.27	4.80
1600	11.79	17.56	26.14	29.66	1.22	0.51	29.28	13.22	4.80
1800	11.70	17.63	25.02	30.95	1.24	0.51	29.14	13.42	4.77
2000	11.61	17.71	23.88	32.96	1.25	0.49	28.93	13.66	4.77
2200	11.52	17.81	22.85	37.48	1.27	0.48	28.82	13.72	4.78
2400	11.43	17.91	21.84	49.61	1.28	0.47	28.51	13.77	4.88
2600	11.35	18.03	20.91	41.84	1.30	0.46	28.26	13.69	4.89
2800	11.25	18.15	20.03	33.72	1.32	0.45	27.86	13.46	4.88
3000	11.17	18.26	18.88	29.26	1.34	0.44	27.73	13.38	4.82
3200	11.08	18.42	17.78	25.97	1.36	0.43	27.54	13.20	4.89
3400	11.00	18.54	16.78	23.52	1.38	0.43	27.31	13.15	4.95
3600	10.92	18.69	15.98	21.61	1.40	0.42	26.71	12.95	5.05
3800	10.84	18.83	15.34	20.12	1.42	0.41	26.07	12.92	5.09
4000	10.77	18.98	14.92	19.06	1.44	0.41	25.65	13.17	5.17
4200	10.73	19.08	14.72	18.48	1.46	0.40	25.84	13.38	5.09
4400	10.69	19.21	14.74	18.06	1.48	0.40	25.89	13.39	5.17
4600	10.66	19.31	14.79	17.79	1.49	0.39	25.52	13.45	5.25
4800	10.67	19.46	14.79	17.59	1.51	0.39	25.11	13.45	5.34
5000	10.64	19.49	15.25	17.60	1.52	0.38	24.82	13.42	5.26
5200	10.64	19.52	15.55	17.60	1.53	0.38	24.70	13.23	5.34
5400	10.70	19.64	15.64	17.48	1.54	0.38	24.61	13.22	5.33
5600	10.73	19.65	16.24	17.66	1.54	0.38	24.27	13.01	5.44
5800	10.81	19.70	16.71	17.38	1.53	0.38	23.80	13.19	5.45
6000	10.89	19.71	17.28	17.09	1.53	0.38	23.25	13.01	5.44
6200	10.98	19.64	18.29	16.94	1.51	0.38	22.90	12.99	5.51
6400	11.08	19.68	18.79	16.63	1.50	0.39	22.64	13.06	5.48
6600	11.17	19.60	19.76	16.22	1.48	0.39	22.60	13.21	5.62
6800	11.33	19.45	20.71	15.29	1.44	0.41	22.25	13.06	5.56
7000	11.44	19.39	20.96	14.62	1.41	0.42	22.01	13.00	5.59

## Typical Performance Curves

### GAIN vs. TEMPERATURE

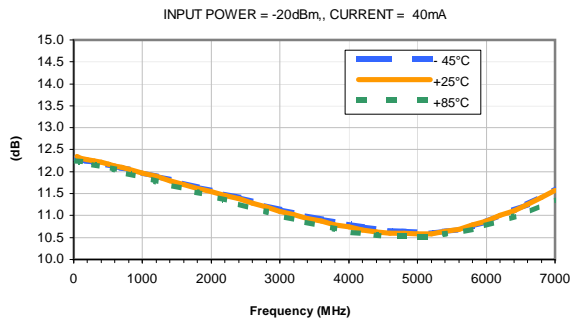

### GAIN vs. CURRENT

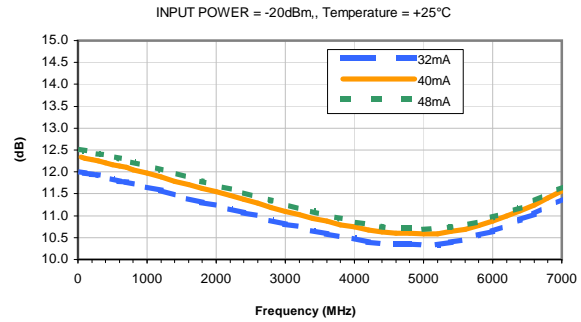

### ISOLATION vs. TEMPERATURE

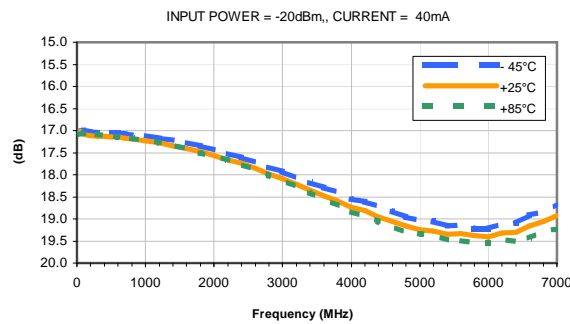

### ISOLATION vs. CURRENT

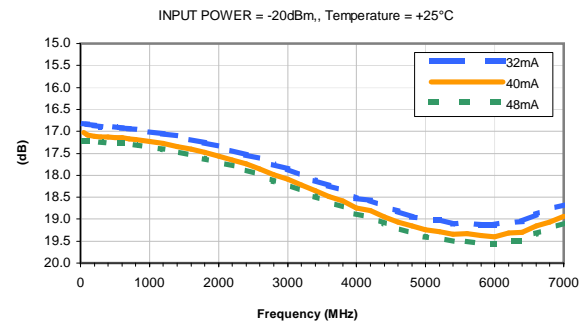

### INPUT RETURN LOSS vs. TEMPERATURE

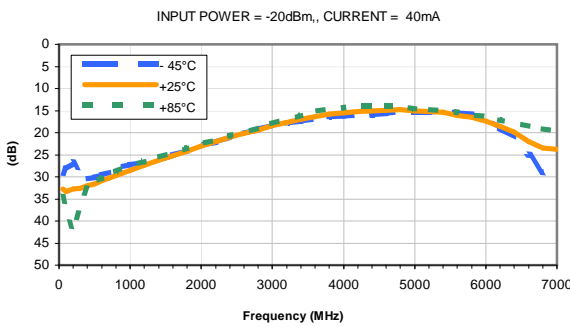

### INPUT RETURN LOSS vs. CURRENT

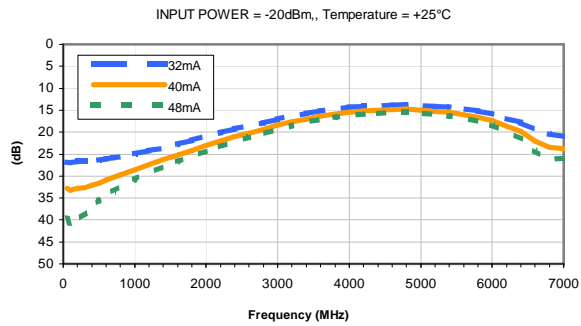

### OUTPUT RETURN LOSS vs. TEMPERATURE

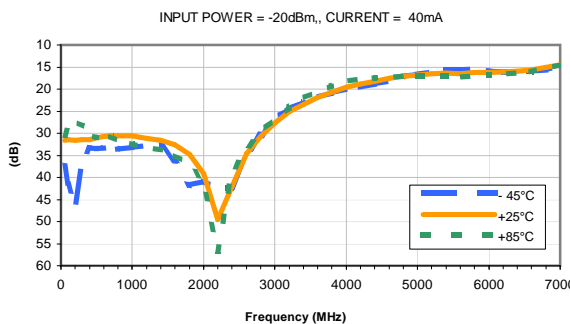

### OUTPUT RETURN LOSS vs. CURRENT

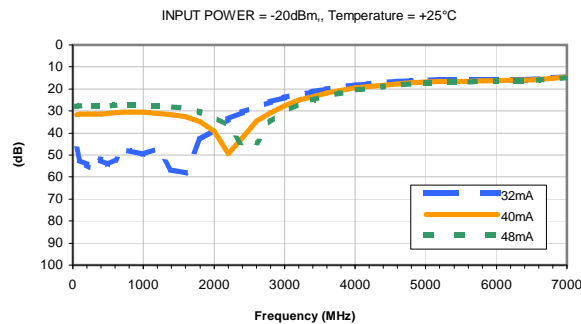

## Typical Performance Curves

**OUTPUT IP3 vs. TEMPERATURE**

INPUT POWER = -20dBm, CURRENT = 40mA

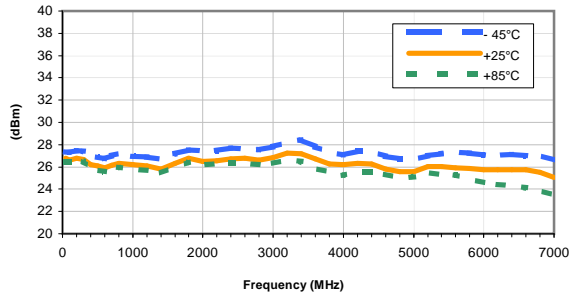

**OUTPUT IP3 vs. CURRENT**

INPUT POWER = -20dBm, Temperature = +25°C

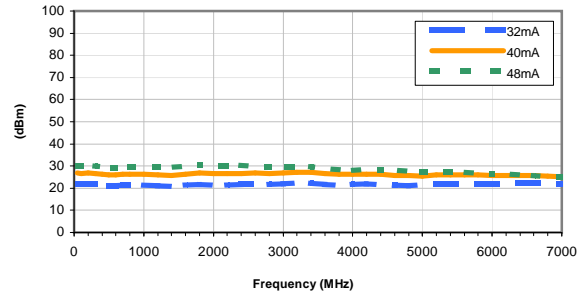

**OUTPUT POWER at 1dB Compression vs. TEMPERATURE**

CURRENT = 40mA

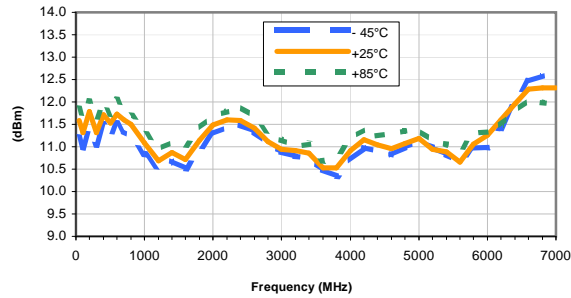

**OUTPUT POWER at 1dB Compression vs. CURRENT**

Temperature = +25°C

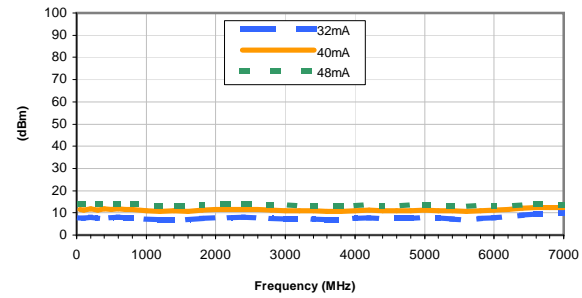

**Noise Figure vs. TEMPERATURE**

CURRENT = 40mA

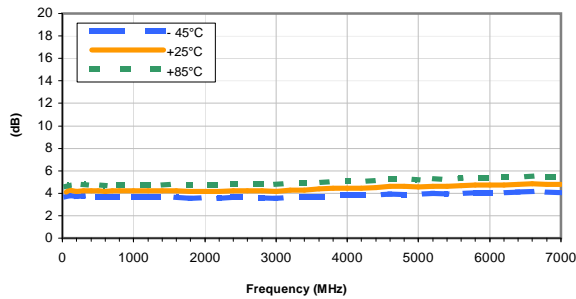

**Noise Figure vs. CURRENT**

Temperature = +25°C

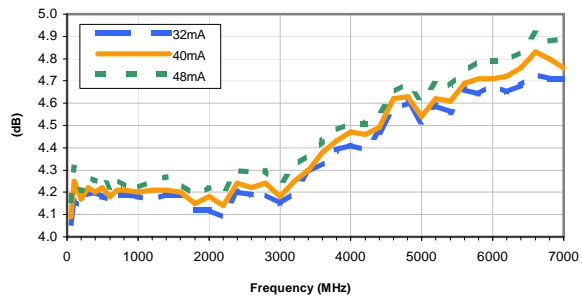

## Typical Performance Curves

**GAIN vs. TEMPERATURE**

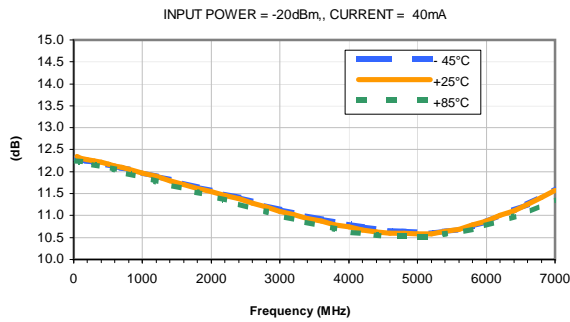

**GAIN vs. CURRENT**

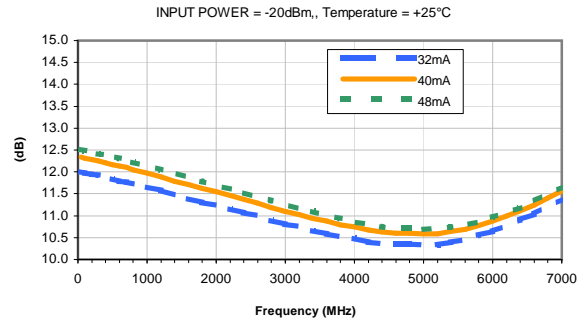

**ISOLATION vs. TEMPERATURE**

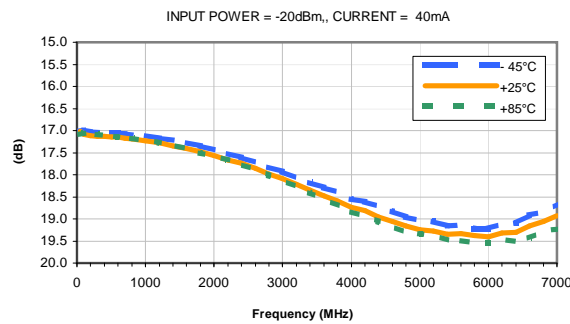

**ISOLATION vs. CURRENT**

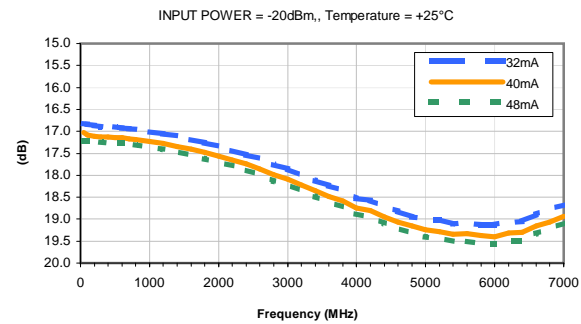

**INPUT RETURN LOSS vs. TEMPERATURE**

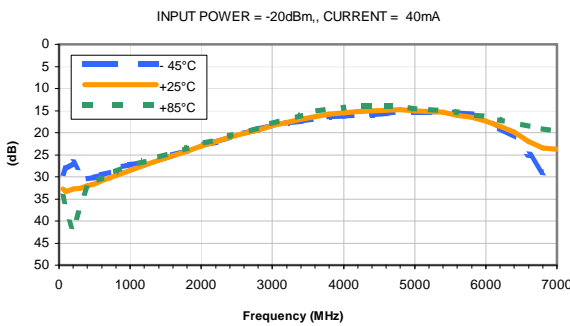

**INPUT RETURN LOSS vs. CURRENT**

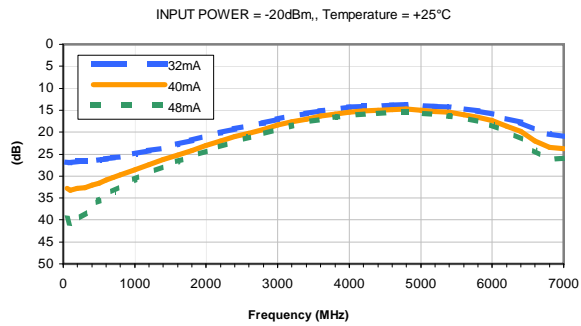

**OUTPUT RETURN LOSS vs. TEMPERATURE**

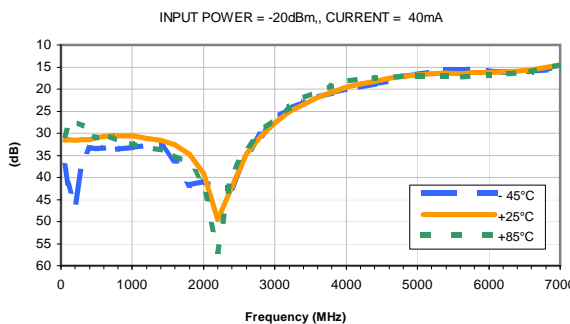

**OUTPUT RETURN LOSS vs. CURRENT**

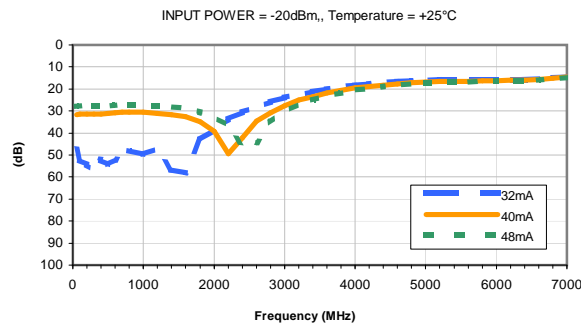



## Typical Performance Curves

**OUTPUT IP3 vs. TEMPERATURE**

INPUT POWER = -20dBm, CURRENT = 40mA

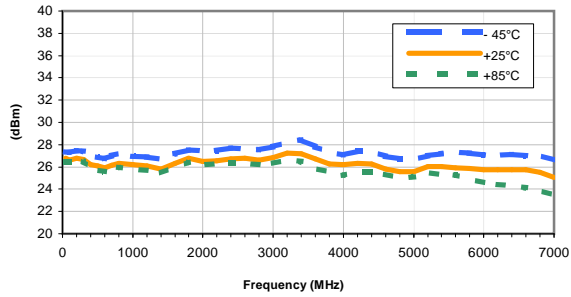

**OUTPUT IP3 vs. CURRENT**

INPUT POWER = -20dBm, Temperature = +25°C

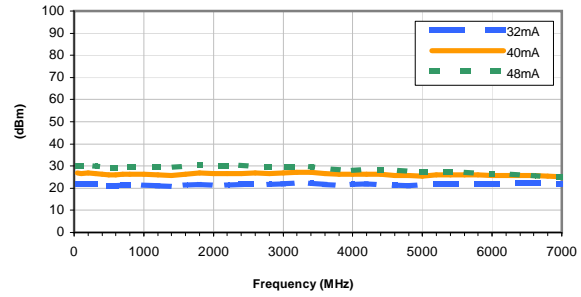

**OUTPUT POWER at 1dB Compression vs. TEMPERATURE**

CURRENT = 40mA

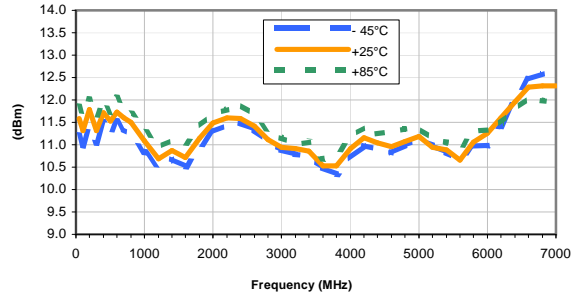

**OUTPUT POWER at 1dB Compression vs. CURRENT**

Temperature = +25°C

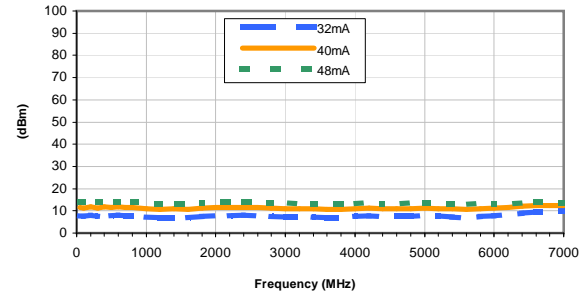

**Noise Figure vs. TEMPERATURE**

CURRENT = 40mA

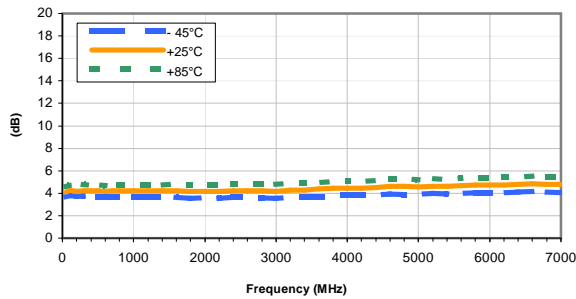

**Noise Figure vs. CURRENT**

Temperature = +25°C

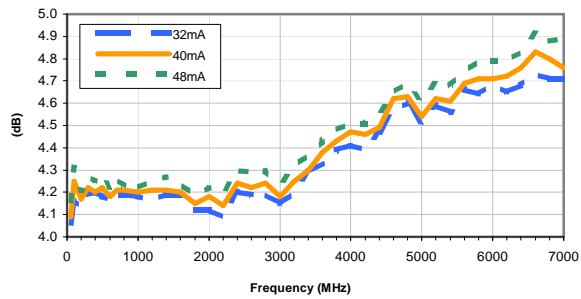

### Outline Dimensions



### PCB Land Pattern



Suggested Layout,  
Tolerance to be within  $\pm .002$

CASE #	A	B	C	D	E	F	G	H	J	K	L	M
DF782	.102 (2.59)	.090 (2.29)	.181 (4.60)	.173 (4.39)	.063 (1.60)	.167 (4.24)	.155 (3.94)	.059 (1.50)	.118 (3.00)	.015 (0.38)	.041 (1.04)	.016 (0.41)

CASE #	N	P	Q	WT. GRAM
DF782	.019 (0.48)	.065 (1.65)	.062 (1.57)	.2

Dimensions are in inches (mm). Tolerances: 2 Pl.  $\pm .01$ ; 3Pl.  $\pm .005$

#### Notes:

- Case material: Plastic.
- Termination finish:  
For RoHS Case Styles: Tin-Silver alloy plate over Nickel barrier or Matte-Tin.  
All models, (+) suffix. See model Data sheet.  
For RoHS-5 Case Styles: Tin-Lead plate. All models, no (+) suffix.



INTERNET <http://www.minicircuits.com>

P.O. Box 350166, Brooklyn, New York 11235-0003 (718) 934-4500 Fax (718) 332-4661

Distribution Centers NORTH AMERICA 800-654-7949 • 417-335-5935 • Fax 417-335-5945 • EUROPE 44-1252-832600 • Fax 44-1252-837010

Mini-Circuits ISO 9001 & ISO 14001 Certified

# Tape & Reel Packaging TR-F55

## DEVICE ORIENTATION IN T&R



Tape Width, mm	Device Cavity Pitch, mm	Reel Size, inches	Devices per Reel	
12	8	7	Small quantity standard (see note)	20
				50
				100
				200
				500
			Standard	1000

Note: Please consult individual model data sheet to determine device per reel availability.

Mini-Circuits carrier tape materials provide protection from ESD (Electro-Static Discharge) during handling and transportation. Tapes are static dissipative and comply with industry standards EIA-481/EIA-541.

Go to: [www.minicircuits.com/pages/pdfs/tape.pdf](http://www.minicircuits.com/pages/pdfs/tape.pdf)



INTERNET <http://www.minicircuits.com>

P.O. Box 350166, Brooklyn, New York 11235-0003 (718) 934-4500 Fax (718) 332-4661

Distribution Centers NORTH AMERICA 800-654-7949 • 417-335-5935 • Fax 417-335-5945 • EUROPE 44-1252-832600 • Fax 44-1252-837010

Mini-Circuits ISO 9001 & ISO 14001 Certified

THIRD ANGLE PROJECTION



REVISIONS

REV	ECN No.	DESCRIPTION	DATE	DR	AUTH
A	M76190	CHANGED DISCRIPTION	04/01	GF	CT
B	M82575	UPDATED DRAWING	08/05/02	AV	LC
C	M102713	ADDED NOTE 2 & "...WITH SMOBC"	01/17/06	MMG	IL
D	M108434	UPDATED DRAWING PER TB-409+	11/14/06	PW	IG

SUGGESTED MOUNTING CONFIGURATION  
FOR DF782 CASE STYLE, "mz" PIN CONNECTION



- NOTES:** 1. TRACE WIDTH IS SHOWN FOR ROGERS R04350B WITH DIELECTRIC THICKNESS .030" ± .002"; COPPER: 1/2 OZ. EACH SIDE. FOR OTHER MATERIALS TRACE WIDTH MAY NEED TO BE MODIFIED.  
2. BOTTOM SIDE OF THE PCB IS CONTINUOUS GROUND PLANE.



DENOTES PCB COPPER LAYOUT WITH SMOBC (SOLDER MASK OVER BARE COPPER)



DENOTES COPPER LAND PATTERN FREE OF SOLDER MASK

UNLESS OTHERWISE SPECIFIED

INITIALS

DATE

DIMENSIONS ARE IN INCHES

DRAWN

AV

01/15/01

TOLERANCES ON:

CHECKED

YB

01/23/01

2 PL DECIMALS ± .005

APPROVED

DB

01/23/01

3 PL DECIMALS ±

ANGLES ±

FRACTIONS ±

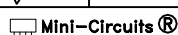

THIS DOCUMENT AND ITS CONTENTS ARE THE PROPERTY OF MINI-CIRCUITS. EXCEPT FOR USE EXPRESSLY GRANTED, IN WRITING, TO ITS VENDORS, VENDEE AND THE UNITED STATES GOVERNMENT, MINI-CIRCUITS RESERVES ALL PROPRIETARY DESIGN, USE, MANUFACTURING AND REPRODUCTION RIGHTS THERETO. THESE CONTENTS SHALL NOT BE USED, DUPLICATED OR DISCLOSED TO ANY OUTSIDE PARTY, IN WHOLE OR IN PART, WITHOUT WRITTEN PERMISSION OF MINI-CIRCUITS.



Mini-Circuits®

13 Neptune Avenue  
Brooklyn NY 11235

PL, mz, DF782, GALI, TB-409-XXX+

SIZE

CODE IDENT

DRAWING NO:

REV:

A

15542

98-PL-019

D

FILE:

98PL019

SCALE:

10:1

SHEET:

1 OF 1

# Evaluation Board and Circuit

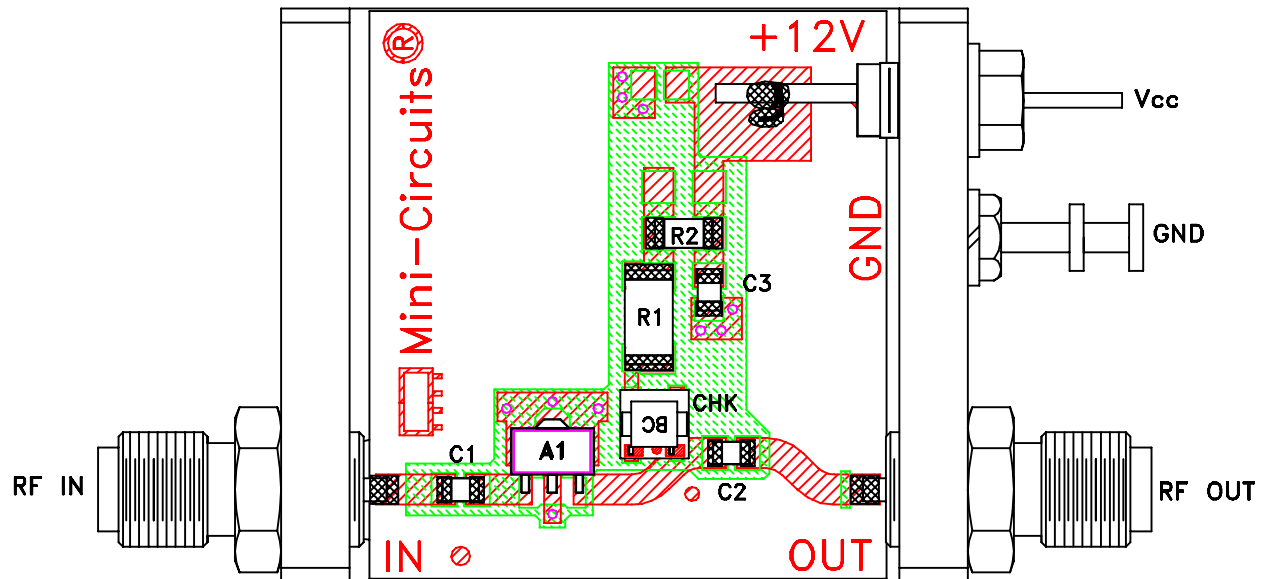

TB-409-19+

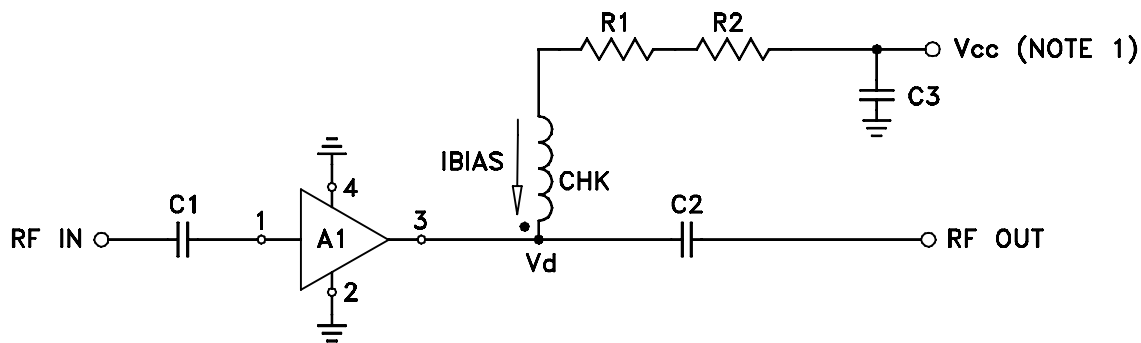

COMPONENT	VALUE
A1	Gali-19(+)
C1 (NOTE 4)	2400 pF
C2 (NOTE 4)	2400 pF
C3 (bypass)	0.1 uF
R1	210 Ohms, 0.75W
R2	0 Ohm, 0.25W
CHK	Mini-Circuits TCCH-80+

Schematic Diagram

**NOTE:**

1. Vcc voltage: +12±0.2V.
2. SMA Female connectors.
3. PCB material: Rogers RO4350 or equivalent, dielectric constant=3.5, dielectric thickness=.030 inch.
4. Capacitors, C1 & C2 should be free of resonance up to the highest frequency specified.

Mini-Circuits®

All Mini-Circuits products are manufactured under exacting quality assurance and control standards, and are capable of meeting published specifications after being subjected to any or all of the following physical and environmental test.

Specification	Test/Inspection Condition	Reference/Spec
Operating Temperature	-45° to 85°C or -40° to 85°C Ambient Environment	Individual Model Data Sheet
Storage Temperature	-65° to 150° C Ambient Environment	Individual Model Data Sheet
Thermal Shock	-55° to 100°C, 100 cycles	MIL-STD-202, Method 107, Condition A-3, except +100°C
Mechanical Shock	1.5Kg, 0.5 ms, 5 shock pulses, Y1 direction only	MIL-STD-883, Method 2002, Condition B, except Y1 direction only
Vibration (Variable Frequency)	50g peak	MIL-STD-883, Method 2007, Condition B
Autoclave	15 psig, 100% RH, 121°C, 96 hours	JESD22-A102, Condition C
HAST	130°C, 85% RH, 96 hours	JESD22-A110
Solderability	10X Magnification	J-STD-002, Para 4.2.5, Test S, 95% Coverage
Solder Reflow Heat	Sn-Pb Eutetic Process: 240°C peak Pb-Free Process: 260°C peak	J-STD-020, Table 4-1, 4-2 and 5-2; Figure 5-1
Moisture Sensitivity: Level 1	Bake at 125°C for 24 hours Soak at 85°C/85% RH for 168 hours, Reflow 3 cycles at 260°C peak	J-STD-020
Marking Resistance to Solvents	Isopropyl alcohol + mineral spirits at 25°C; terpene defluxer at 25°C; distilled water + proylene glycol monomethyl ether +	MIL-STD-202, Method 215



All Mini-Circuits products are manufactured under exacting quality assurance and control standards, and are capable of meeting published specifications after being subjected to any or all of the following physical and environmental test.

Specification	Test/Inspection Condition	Reference/Spec
	monoethanolamine at 63°C to 70°C	