

Surface Mount

# Monolithic Amplifier

DC-5 GHz

## Features

- Miniature SOT-89 Package
- Frequency range, DC to 5 GHz
- Internally Matched to 50 Ohms
- Output power, 16.4 dBm typ.
- Excellent package for heat dissipation, exposed metal bottom
- Aqueous washable
- Protected by US Patent 6,943,629

## Applications

- Cellular
- PCS
- Communication receivers & transmitters

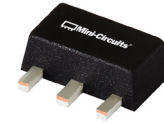

Generic photo used for illustration purposes only

**Gali-49+**

CASE STYLE: DF782

**+RoHS Compliant**

The +Suffix identifies RoHS Compliance. See our web site for RoHS Compliance methodologies and qualifications

## General Description

Gali-49+ (RoHS compliant) is a wideband amplifier offering high dynamic range. It has repeatable performance from lot to lot, and is enclosed in a SOT-89 package. It uses patented Transient Protected Darlington configuration and is fabricated using InGaP HBT technology. Gali-49+ is designed to be rugged for ESD and supply switch-on transients.

## simplified schematic and pin description

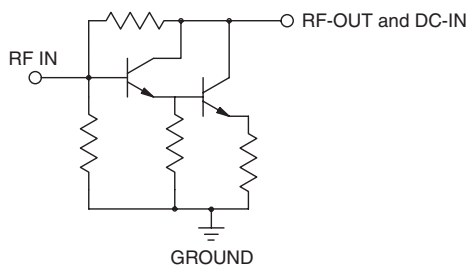

Function	Pin Number	Description
RF IN	1	RF input pin. This pin requires the use of an external DC blocking capacitor chosen for the frequency of operation.
RF-OUT and DC-IN	3	RF output and bias pin. DC voltage is present on this pin; therefore a DC blocking capacitor is necessary for proper operation. An RF choke is needed to feed DC bias without loss of RF signal due to the bias connection, as shown in "Recommended Application Circuit".
GND	2,4	Connections to ground. Use via holes as shown in "Suggested Layout for PCB Design" to reduce ground path inductance for best performance.

### Notes

- A. Performance and quality attributes and conditions not expressly stated in this specification document are intended to be excluded and do not form a part of this specification document.  
B. Electrical specifications and performance data contained in this specification document are based on Mini-Circuit's applicable established test performance criteria and measurement instructions.  
C. The parts covered by this specification document are subject to Mini-Circuits standard limited warranty and terms and conditions (collectively, "Standard Terms"); Purchasers of this part are entitled to the rights and benefits contained therein. For a full statement of the Standard Terms and the exclusive rights and remedies thereunder, please visit Mini-Circuits' website at [www.minicircuits.com/MCLStore/terms.jsp](http://www.minicircuits.com/MCLStore/terms.jsp)



**Electrical Specifications at 25°C and 65mA, unless noted**

Parameter		Min.	Typ.	Max.	Units
Frequency Range*		DC		5	GHz
Gain	f=0.1 GHz	—	14.0	—	dB
	f=1 GHz	—	13.7	—	
	f=2 GHz	11.5	13.6	—	
	f=3 GHz	—	12.9	—	
	f=4 GHz	—	12.4	—	
	f=5 GHz	—	12.0	—	
	f=7 GHz	—	12.0	—	
Input Return Loss	f= DC to 3 GHz		20		dB
	f= 3 to 5 GHz		18		
Output Return Loss	f= DC to 3 GHz		20		dB
	f= 3 to 5 GHz		18		
Output Power @ 1 dB compression	f=2 GHz	15.0	16.4	—	dBm
Output IP3	f=1 GHz		33.3		dBm
Noise Figure	f=2 GHz		4.4		dB
Recommended Device Operating Current			65		mA
Device Operating Voltage		4.3	4.5	4.85	V
Device Voltage Variation vs. Temperature at 65 mA			-2.9		mV/°C
Device Voltage Variation vs. Current at 25°C			10.4		mV/mA
Thermal Resistance, junction-to-case <sup>1</sup>			93		°C/W

\*Guaranteed specification DC-5 GHz. Low frequency cut off determined by external coupling capacitors.

**Absolute Maximum Ratings**

Parameter	Ratings
Operating Temperature*	-45°C to 85°C
Storage Temperature	-65°C to 150°C
Operating Current	85mA
Input Power	20dBm

Note: Permanent damage may occur if any of these limits are exceeded. These ratings are not intended for continuous normal operation.

<sup>1</sup>Case is defined as ground leads.

\*Based on typical case temperature rise 5°C above ambient.

**Notes**

- A. Performance and quality attributes and conditions not expressly stated in this specification document are intended to be excluded and do not form a part of this specification document.
- B. Electrical specifications and performance data contained in this specification document are based on Mini-Circuit's applicable established test performance criteria and measurement instructions.
- C. The parts covered by this specification document are subject to Mini-Circuits standard limited warranty and terms and conditions (collectively, "Standard Terms"); Purchasers of this part are entitled to the rights and benefits contained therein. For a full statement of the Standard Terms and the exclusive rights and remedies thereunder, please visit Mini-Circuits' website at [www.minicircuits.com/MCLStore/terms.jsp](http://www.minicircuits.com/MCLStore/terms.jsp)



**Product Marking**

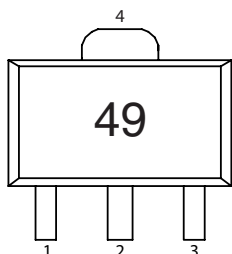

Markings in addition to model number designation may appear for internal quality control purposes.

**Additional Detailed Technical Information**

Additional information is available on our web site. To access this information enter the model number on our web site home page.

**Performance data, graphs, s-parameter data set (.zip file)**

**Case Style: DF782**

Plastic package, exposed paddle, lead finish: Matte-Tin

**Tape & Reel: F55**

7” reels with 20, 50, 100, 200, 500, 1K devices.

**Suggested Layout for PCB Design: PL-019**

**Evaluation Board: TB-409-49+**

**Environmental Ratings: ENV08T2**

**Recommended Application Circuit**

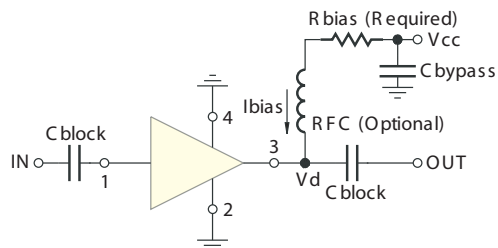

Test Board includes case, connectors, and components (in bold) soldered to PCB

R BIAS	
Vcc	“1%” Res. Values (ohms) for Optimum Biasing
7	34.0
8	48.7
9	64.9
10	80.6
11	95.3
12	110
13	127
14	143
15	158
16	174
17	187
18	205
19	221
20	237

**Notes**

- A. Performance and quality attributes and conditions not expressly stated in this specification document are intended to be excluded and do not form a part of this specification document.
- B. Electrical specifications and performance data contained in this specification document are based on Mini-Circuit's applicable established test performance criteria and measurement instructions.
- C. The parts covered by this specification document are subject to Mini-Circuits standard limited warranty and terms and conditions (collectively, "Standard Terms"); Purchasers of this part are entitled to the rights and benefits contained therein. For a full statement of the Standard Terms and the exclusive rights and remedies thereunder, please visit Mini-Circuits' website at [www.minicircuits.com/MCLStore/terms.jsp](http://www.minicircuits.com/MCLStore/terms.jsp)



**ESD Rating**

Human Body Model (HBM): Class 1A (250V to < 500V) in accordance with ANSI/ESD STM 5.1 - 2001

Machine Model (MM): Class M1 (< 100V) in accordance with ANSI/ESD STM 5.2 - 1999

**MSL Rating**

Moisture Sensitivity: MSL1 in accordance with IPC/JEDECJ-STD-020C

No.	Test Required	Condition	Standard	Quantity
1	Visual Inspection	Low Power Microscope Magnification 40x	MIP-IN-0003 (MCT spec)	45 units
2	Electrical Test	Room Temperature	SCD (MCL spec)	45 units
3	SAM Analysis	Less than 10% growth in term of delamination	J-Std-020C (Jedec Standard)	45 units
4	Moisture Sensitivity Level 1	Bake at 125°C for 24 hours Soak at 85°C/85%RH for 168 hours Reflow 3 cycles at 260°C peak	J-Std-020C (Jedec Standard)	45 units

**MSL Test Flow Chart**

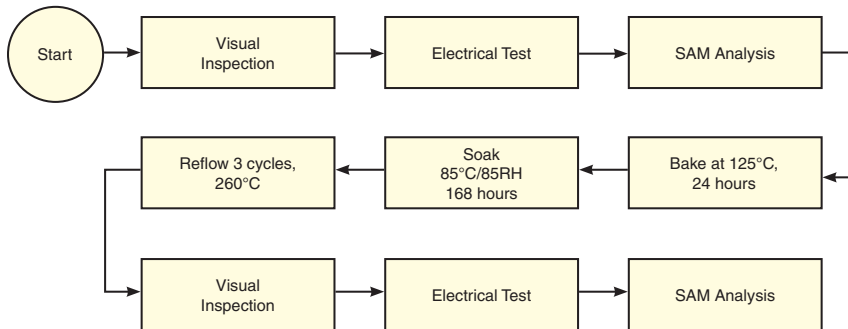

**Notes**

- A. Performance and quality attributes and conditions not expressly stated in this specification document are intended to be excluded and do not form a part of this specification document.
- B. Electrical specifications and performance data contained in this specification document are based on Mini-Circuit's applicable established test performance criteria and measurement instructions.
- C. The parts covered by this specification document are subject to Mini-Circuits standard limited warranty and terms and conditions (collectively, "Standard Terms"); Purchasers of this part are entitled to the rights and benefits contained therein. For a full statement of the Standard Terms and the exclusive rights and remedies thereunder, please visit Mini-Circuits' website at [www.minicircuits.com/MCLStore/terms.jsp](http://www.minicircuits.com/MCLStore/terms.jsp)



## Typical Performance Data

**NOTE: Use PDF Bookmarks to view DATA at required conditions**

**Definitions:**

Input Return Loss = -S11 (dB)

Gain(Power Gain) = S21 (dB)

Reverse Isolation = -S12 (dB)

Output Return Loss = -S22 (dB)

TEST CONDITIONS: Id = 65mA, Vd = 4.47V @ Temperature = +25degC

FREQ	Gain	Isolation	Input Return Loss	Output Return Loss	Stability		IP-3 Output	1dB Comp. Output	Noise Figure
					K	Measure			
(MHz)	(dB)	(dB)	(dB)	(dB)	K	Measure	(dBm)	(dBm)	(dB)
20.0	14.43	19.00	42.49	41.48	1.14	0.65	33.49	16.41	4.15
30.0	14.44	19.01	49.93	41.18	1.14	0.65	34.25	16.60	4.17
40.0	14.43	19.05	51.79	40.22	1.14	0.65	35.62	16.87	4.21
50.0	14.43	19.04	52.39	40.38	1.14	0.65	35.47	16.95	4.21
60.0	14.42	19.02	47.59	40.55	1.14	0.65	33.81	18.14	4.14
70.0	14.41	19.04	45.84	40.67	1.15	0.66	36.16	18.06	4.21
80.0	14.41	19.04	45.73	40.54	1.15	0.66	36.85	18.08	4.17
90.0	14.41	19.04	48.10	39.60	1.15	0.66	34.36	18.07	4.14
100.0	14.40	19.06	49.47	39.52	1.15	0.66	34.77	18.03	4.16
200.0	14.35	19.06	41.64	38.42	1.15	0.66	35.39	17.98	4.16
300.0	14.31	19.08	40.00	36.62	1.15	0.67	39.24	18.00	4.32
400.0	14.26	19.07	36.94	34.72	1.16	0.67	40.90	18.10	4.33
500.0	14.21	19.09	35.55	33.01	1.16	0.67	33.60	18.03	4.39
600.0	14.16	19.11	34.10	31.37	1.17	0.68	37.75	18.02	4.34
700.0	14.12	19.12	32.92	30.38	1.17	0.68	35.58	17.97	4.38
800.0	14.07	19.15	31.93	29.17	1.17	0.69	37.49	17.95	4.27
900.0	14.02	19.16	31.17	28.45	1.18	0.69	33.82	17.86	4.33
1000.0	13.97	19.21	30.58	27.70	1.19	0.70	32.69	17.77	4.32
1200.0	13.87	19.26	29.28	26.62	1.20	0.71	34.90	17.72	4.34
1400.0	13.77	19.34	28.21	26.08	1.21	0.72	33.11	17.54	4.39
1600.0	13.66	19.44	27.63	25.95	1.23	0.73	33.76	17.28	4.38
1800.0	13.56	19.54	26.85	26.13	1.24	0.75	32.69	16.84	4.40
2000.0	13.45	19.61	26.06	26.64	1.26	0.76	31.31	16.62	4.39
2200.0	13.35	19.78	25.23	27.63	1.28	0.77	31.86	16.31	4.48
2400.0	13.23	19.86	24.47	28.82	1.30	0.78	30.79	15.78	4.46
2600.0	13.13	20.01	23.58	30.46	1.33	0.80	29.50	15.32	4.52
2800.0	13.02	20.17	22.60	32.39	1.35	0.81	28.86	14.87	4.66
3000.0	12.90	20.35	21.67	34.83	1.38	0.83	28.13	14.45	4.63
3200.0	12.79	20.53	20.72	37.87	1.41	0.84	27.50	14.12	4.65
3400.0	12.71	20.74	19.61	39.95	1.45	0.85	26.74	13.72	4.65
3600.0	12.60	20.91	18.66	38.39	1.48	0.87	26.04	13.28	4.73
3800.0	12.49	21.15	17.79	36.73	1.52	0.88	25.64	12.89	4.77
4000.0	12.40	21.36	16.96	34.37	1.55	0.89	25.16	12.53	4.74
4200.0	12.32	21.66	16.17	32.49	1.60	0.91	24.92	12.17	4.82
4400.0	12.20	21.97	15.64	30.89	1.66	0.92	24.43	11.88	4.91
4600.0	11.97	21.90	15.25	32.87	1.68	0.93	24.17	11.52	4.99
4800.0	11.96	22.25	14.41	31.39	1.73	0.94	23.53	11.10	5.04
5000.0	11.87	22.49	13.99	30.41	1.78	0.95	22.98	10.63	5.10
5200.0	11.97	23.19	13.45	25.58	1.88	0.96	22.67	10.24	5.10
5400.0	11.73	22.80	13.61	27.46	1.86	0.96	21.75	9.65	5.31
5600.0	11.86	23.49	12.81	23.92	1.94	0.97	21.75	9.63	5.25
5800.0	11.77	23.19	13.04	24.24	1.91	0.97	20.90	9.04	5.38
6000.0	11.85	24.02	11.88	21.84	2.02	0.99	20.69	8.59	5.33
6200.0	11.88	24.01	11.94	20.93	2.02	0.99	20.16	8.28	5.39
6400.0	11.85	24.25	11.68	21.06	2.06	0.99	19.62	7.91	5.46
6600.0	11.85	24.51	11.55	20.56	2.11	1.00	19.25	7.51	5.48
6800.0	11.94	24.15	12.04	21.35	2.04	0.99	18.57	7.16	5.59
7000.0	11.93	24.35	12.03	21.26	2.09	0.99	18.36	6.81	5.58



## Typical Performance Data

**Definitions:**

Input Return Loss = -S11 (dB)

Gain(Power Gain) = S21 (dB)

Reverse Isolation = -S12 (dB)

Output Return Loss = -S22 (dB)

TEST CONDITIONS: Id = 52mA, Vd = 4.35V @ Temperature = +25degC

FREQ	Gain	Isolation	Input Return Loss	Output Return Loss	Stability		IP-3 Output	1dB Comp. Output	Noise Figure
					K	Measure			
(MHz)	(dB)	(dB)	(dB)	(dB)	K	Measure	(dBm)	(dBm)	(dB)
20.0	14.31	18.88	46.38	48.52	1.14	0.65	42.36	15.15	4.09
30.0	14.32	18.92	43.18	50.70	1.14	0.65	30.77	15.21	4.10
40.0	14.31	18.93	41.03	54.80	1.14	0.65	38.36	15.21	4.13
50.0	14.31	18.91	39.54	57.22	1.14	0.65	36.51	15.28	4.14
60.0	14.30	18.95	40.63	52.21	1.15	0.66	36.44	16.61	4.07
70.0	14.30	18.94	41.54	54.01	1.15	0.66	32.16	16.58	4.10
80.0	14.29	18.95	43.04	50.29	1.15	0.66	34.37	16.50	4.05
90.0	14.29	18.94	43.71	50.77	1.15	0.66	31.25	16.52	4.08
100.0	14.28	18.97	42.98	50.20	1.15	0.66	31.23	16.51	4.06
200.0	14.24	18.99	39.72	46.15	1.15	0.66	32.29	16.28	4.05
300.0	14.20	18.99	38.89	42.27	1.16	0.67	33.73	16.27	4.18
400.0	14.14	18.99	36.87	38.79	1.16	0.67	33.73	16.45	4.25
500.0	14.10	19.00	36.21	36.18	1.16	0.68	32.32	16.37	4.26
600.0	14.05	19.04	34.70	34.00	1.17	0.68	34.30	16.42	4.26
700.0	14.01	19.05	33.74	32.52	1.17	0.69	31.62	16.42	4.30
800.0	13.96	19.03	32.78	31.23	1.17	0.69	32.24	16.39	4.19
900.0	13.91	19.09	32.01	30.33	1.18	0.70	32.83	16.19	4.24
1000.0	13.86	19.11	31.49	29.49	1.19	0.70	31.02	16.16	4.19
1200.0	13.76	19.18	30.05	28.15	1.20	0.71	32.62	16.31	4.22
1400.0	13.67	19.25	28.79	27.58	1.21	0.72	31.53	16.13	4.29
1600.0	13.56	19.34	28.04	27.42	1.23	0.73	31.58	16.12	4.25
1800.0	13.45	19.43	27.09	27.70	1.24	0.75	30.90	15.92	4.30
2000.0	13.34	19.52	26.17	28.26	1.26	0.76	29.82	15.60	4.32
2200.0	13.24	19.63	25.21	29.54	1.28	0.77	29.81	15.36	4.35
2400.0	13.13	19.78	24.29	30.97	1.30	0.79	28.65	14.96	4.34
2600.0	13.02	19.93	23.32	33.17	1.33	0.80	28.74	14.49	4.43
2800.0	12.91	20.07	22.28	35.90	1.35	0.81	27.57	14.02	4.55
3000.0	12.79	20.24	21.32	39.40	1.38	0.83	26.76	13.62	4.47
3200.0	12.69	20.44	20.33	41.58	1.41	0.84	26.50	13.26	4.47
3400.0	12.60	20.65	19.23	40.06	1.45	0.85	25.74	12.88	4.49
3600.0	12.49	20.83	18.28	36.86	1.48	0.87	25.48	12.45	4.60
3800.0	12.38	21.01	17.44	35.05	1.51	0.88	24.70	12.07	4.60
4000.0	12.28	21.27	16.58	32.94	1.56	0.89	24.12	11.68	4.58
4200.0	12.21	21.56	15.84	31.06	1.60	0.91	23.75	11.34	4.67
4400.0	12.08	21.86	15.29	29.72	1.66	0.92	23.45	11.03	4.75
4600.0	11.84	21.82	14.92	32.01	1.69	0.93	22.98	10.66	4.79
4800.0	11.83	22.17	14.10	29.88	1.73	0.94	22.51	10.25	4.88
5000.0	11.73	22.37	13.67	28.94	1.78	0.95	21.88	9.80	4.92
5200.0	11.82	23.09	13.12	24.76	1.88	0.97	21.58	9.41	4.90
5400.0	11.58	22.70	13.27	26.59	1.86	0.96	20.72	8.79	5.13
5600.0	11.71	23.33	12.50	23.18	1.93	0.98	20.62	8.76	5.04
5800.0	11.60	23.08	12.70	23.64	1.91	0.97	19.84	8.19	5.18
6000.0	11.67	23.91	11.61	21.27	2.02	0.99	19.50	7.74	5.13
6200.0	11.70	23.86	11.67	20.51	2.01	0.99	19.13	7.43	5.22
6400.0	11.66	24.13	11.42	20.61	2.07	1.00	18.59	7.09	5.23
6600.0	11.65	24.37	11.31	20.15	2.12	1.00	18.21	6.70	5.27
6800.0	11.73	24.08	11.76	21.01	2.06	0.99	17.55	6.33	5.36
7000.0	11.70	24.21	11.77	20.95	2.09	0.99	17.35	6.02	5.34



## Typical Performance Data

### Definitions:

Input Return Loss = -S11 (dB)

Gain(Power Gain) = S21 (dB)

Reverse Isolation = -S12 (dB)

Output Return Loss = -S22 (dB)

TEST CONDITIONS: Id = 78mA, Vd = 4.59V @ Temperature = +25degC

FREQ	Gain	Isolation	Input Return Loss	Output Return Loss	Stability		IP-3 Output	1dB Comp. Output	Noise Figure
					K	Measure			
(MHz)	(dB)	(dB)	(dB)	(dB)	K	Measure	(dBm)	(dBm)	(dB)
20.0	14.50	19.00	37.52	36.32	1.14	0.64	33.16	16.76	4.27
30.0	14.51	19.09	40.68	36.31	1.14	0.65	30.39	16.98	4.29
40.0	14.51	19.12	43.06	35.84	1.14	0.65	39.98	17.55	4.31
50.0	14.50	19.09	45.31	35.96	1.14	0.65	35.88	17.60	4.34
60.0	14.49	19.11	42.22	35.81	1.14	0.65	38.89	18.56	4.27
70.0	14.49	19.11	40.44	35.90	1.15	0.66	34.54	18.44	4.33
80.0	14.48	19.11	39.81	35.97	1.14	0.65	42.19	18.54	4.26
90.0	14.48	19.12	39.95	35.48	1.15	0.66	37.32	18.50	4.25
100.0	14.47	19.11	41.17	35.53	1.15	0.66	38.04	18.46	4.26
200.0	14.43	19.13	38.75	34.79	1.15	0.66	40.69	18.67	4.25
300.0	14.38	19.13	37.76	33.97	1.15	0.66	37.13	18.83	4.46
400.0	14.33	19.17	35.29	32.33	1.16	0.67	41.12	18.88	4.45
500.0	14.28	19.15	34.08	30.96	1.16	0.67	37.42	18.94	4.48
600.0	14.23	19.18	32.83	29.77	1.17	0.68	37.78	18.94	4.46
700.0	14.19	19.20	31.84	28.84	1.17	0.68	37.36	18.86	4.47
800.0	14.14	19.22	30.87	28.01	1.18	0.69	37.67	18.80	4.38
900.0	14.08	19.23	30.17	27.26	1.18	0.69	35.56	18.88	4.41
1000.0	14.04	19.25	29.69	26.62	1.18	0.70	34.35	18.74	4.42
1200.0	13.94	19.31	28.48	25.64	1.20	0.71	36.03	18.44	4.38
1400.0	13.84	19.38	27.54	25.14	1.21	0.72	34.30	18.26	4.50
1600.0	13.73	19.49	27.03	24.99	1.23	0.73	34.14	17.87	4.49
1800.0	13.63	19.59	26.44	25.11	1.24	0.74	32.17	17.35	4.53
2000.0	13.52	19.70	25.75	25.60	1.26	0.76	34.70	17.23	4.58
2200.0	13.42	19.82	25.04	26.52	1.28	0.77	33.15	16.89	4.58
2400.0	13.31	19.93	24.39	27.50	1.30	0.78	30.87	16.36	4.63
2600.0	13.20	20.07	23.68	29.03	1.33	0.80	30.75	15.93	4.67
2800.0	13.09	20.23	22.76	30.62	1.35	0.81	30.21	15.51	4.78
3000.0	12.98	20.41	21.87	32.64	1.38	0.82	28.82	15.15	4.70
3200.0	12.87	20.57	20.99	34.90	1.41	0.84	28.51	14.83	4.73
3400.0	12.79	20.80	19.90	37.78	1.44	0.85	27.48	14.42	4.77
3600.0	12.68	20.94	18.95	37.50	1.47	0.86	27.24	13.99	4.83
3800.0	12.58	21.20	18.09	36.59	1.52	0.88	26.76	13.64	4.92
4000.0	12.49	21.38	17.24	35.09	1.55	0.89	26.06	13.26	4.91
4200.0	12.42	21.68	16.46	33.17	1.59	0.90	25.66	12.91	4.97
4400.0	12.30	22.01	15.95	31.48	1.66	0.92	25.49	12.65	5.03
4600.0	12.07	21.97	15.52	33.12	1.68	0.92	25.15	12.31	5.11
4800.0	12.07	22.35	14.70	32.14	1.73	0.94	24.65	11.90	5.16
5000.0	11.98	22.55	14.27	31.29	1.78	0.95	23.95	11.46	5.25
5200.0	12.09	23.22	13.77	26.19	1.87	0.96	23.72	11.05	5.24
5400.0	11.85	22.86	13.93	28.09	1.85	0.96	22.88	10.45	5.48
5600.0	11.99	23.50	13.13	24.34	1.92	0.97	22.73	10.45	5.44
5800.0	11.91	23.25	13.36	24.77	1.90	0.96	22.01	9.85	5.49
6000.0	12.00	24.06	12.16	22.17	2.01	0.99	21.62	9.40	5.52
6200.0	12.04	24.03	12.23	21.23	2.00	0.98	21.17	9.08	5.55
6400.0	12.03	24.30	11.94	21.32	2.04	0.99	20.72	8.73	5.63
6600.0	12.04	24.55	11.80	20.74	2.09	0.99	20.28	8.31	5.61
6800.0	12.14	24.25	12.28	21.55	2.02	0.98	19.54	7.97	5.78
7000.0	12.15	24.41	12.26	21.32	2.06	0.98	19.32	7.61	5.79

## Typical Performance Data

### Definitions:

Input Return Loss = -S11 (dB)

Gain(Power Gain) = S21 (dB)

Reverse Isolation = -S12 (dB)

Output Return Loss = -S22 (dB)

TEST CONDITIONS: Id = 65mA, Vd = 4.7V @ Temperature = -45degC

FREQ	Gain	Isolation	Input Return Loss	Output Return Loss	Stability		IP-3 Output	1dB Comp. Output	Noise Figure
					K	Measure			
(MHz)	(dB)	(dB)	(dB)	(dB)	K	Measure	(dBm)	(dBm)	(dB)
20.0	14.51	19.02	44.21	42.81	1.14	0.65	34.68	16.85	3.61
30.0	14.52	19.06	55.49	43.36	1.14	0.65	32.22	16.99	3.64
40.0	14.51	19.05	46.56	44.04	1.14	0.65	41.29	17.11	3.60
50.0	14.51	19.06	41.86	45.27	1.14	0.65	39.39	17.20	3.63
60.0	14.50	19.05	41.31	47.30	1.14	0.65	42.36	18.47	3.57
70.0	14.49	19.05	40.13	51.80	1.14	0.65	42.44	18.43	3.60
80.0	14.49	19.05	40.70	59.47	1.14	0.65	32.88	18.40	3.58
90.0	14.49	19.07	40.38	59.78	1.14	0.65	38.05	18.41	3.59
100.0	14.48	19.07	38.90	56.32	1.14	0.65	35.04	18.38	3.54
200.0	14.45	19.10	38.04	43.78	1.15	0.66	35.45	18.19	3.50
300.0	14.41	19.05	40.08	34.93	1.15	0.66	40.98	18.23	3.60
400.0	14.37	19.09	36.56	32.56	1.15	0.66	38.09	18.36	3.69
500.0	14.33	19.07	36.82	32.42	1.15	0.66	36.08	18.30	3.68
600.0	14.28	19.08	34.25	31.27	1.16	0.67	37.39	18.33	3.68
700.0	14.24	19.10	33.37	31.11	1.16	0.67	36.82	18.30	3.66
800.0	14.20	19.13	33.14	30.04	1.16	0.68	37.26	18.27	3.62
900.0	14.15	19.15	31.67	28.42	1.17	0.68	36.22	18.14	3.67
1000.0	14.11	19.17	30.91	27.24	1.17	0.69	33.12	18.09	3.65
1200.0	14.02	19.23	29.19	25.35	1.18	0.70	36.55	18.19	3.61
1400.0	13.93	19.30	27.49	25.01	1.20	0.71	35.05	18.05	3.66
1600.0	13.82	19.36	26.70	24.45	1.21	0.72	36.31	17.94	3.67
1800.0	13.72	19.44	26.22	24.73	1.22	0.73	35.04	17.61	3.68
2000.0	13.62	19.53	25.20	25.35	1.24	0.74	33.80	17.42	3.68
2200.0	13.52	19.67	24.57	25.92	1.26	0.76	33.88	17.13	3.73
2400.0	13.42	19.75	23.94	27.06	1.27	0.77	32.71	16.64	3.71
2600.0	13.32	19.91	23.35	29.48	1.30	0.78	31.29	16.19	3.80
2800.0	13.21	20.02	22.67	31.58	1.32	0.79	30.45	15.78	3.89
3000.0	13.12	20.22	22.17	34.73	1.35	0.81	30.80	15.39	3.84
3200.0	13.03	20.36	21.24	35.70	1.37	0.82	29.48	15.03	3.85
3400.0	12.93	20.51	20.33	36.18	1.40	0.83	28.72	14.58	3.85
3600.0	12.83	20.77	19.63	36.46	1.44	0.85	28.08	14.16	3.93
3800.0	12.73	20.95	18.75	34.05	1.47	0.86	27.41	13.86	3.95
4000.0	12.63	21.12	18.01	34.05	1.50	0.87	27.39	13.50	3.90
4200.0	12.59	21.34	17.17	37.36	1.53	0.88	26.85	13.15	4.00
4400.0	12.50	21.59	16.31	37.79	1.57	0.90	26.28	12.93	4.02
4600.0	12.37	21.93	16.35	31.70	1.64	0.91	26.30	12.61	4.09
4800.0	12.29	21.98	15.39	34.43	1.65	0.92	25.47	12.23	4.14
5000.0	12.32	22.42	14.73	31.65	1.71	0.93	25.08	11.85	4.17
5200.0	12.15	22.40	14.17	34.59	1.72	0.94	24.82	11.34	4.20
5400.0	12.24	22.90	13.96	28.27	1.79	0.95	23.92	10.86	4.36
5600.0	12.23	23.10	13.05	26.59	1.81	0.96	23.95	10.81	4.33
5800.0	12.19	23.24	12.97	25.83	1.84	0.96	22.96	10.15	4.43
6000.0	12.29	23.65	12.42	23.32	1.88	0.97	22.52	9.75	4.41
6200.0	12.41	23.96	12.00	22.08	1.91	0.98	22.02	9.44	4.42
6400.0	12.25	23.60	12.21	24.08	1.87	0.98	21.53	9.08	4.55
6600.0	12.41	23.84	12.24	22.65	1.89	0.97	21.15	8.71	4.50
6800.0	12.49	24.27	11.87	21.87	1.95	0.98	20.51	8.27	4.59
7000.0	12.61	24.05	12.51	21.69	1.90	0.97	20.12	7.96	4.60



## Typical Performance Data

**Definitions:**

Input Return Loss = -S11 (dB)

Gain(Power Gain) = S21 (dB)

Reverse Isolation = -S12 (dB)

Output Return Loss = -S22 (dB)

TEST CONDITIONS: Id = 52mA, Vd = 4.58V @ Temperature = -45degC

FREQ	Gain	Isolation	Input Return Loss	Output Return Loss	Stability		IP-3 Output	1dB Comp. Output	Noise Figure
					K	Measure			
(MHz)	(dB)	(dB)	(dB)	(dB)			(dBm)	(dBm)	(dB)
20.0	14.41	18.99	44.30	53.44	1.14	0.65	30.85	15.32	3.52
30.0	14.41	18.98	41.30	52.51	1.14	0.65	32.75	15.36	3.55
40.0	14.41	18.98	38.37	52.72	1.14	0.65	33.86	15.28	3.53
50.0	14.40	18.97	36.05	48.97	1.14	0.65	32.53	15.35	3.55
60.0	14.39	18.97	35.94	46.08	1.14	0.65	35.47	16.70	3.46
70.0	14.39	18.97	35.70	43.77	1.14	0.65	37.74	16.69	3.52
80.0	14.39	18.97	35.97	41.83	1.14	0.65	31.97	16.58	3.44
90.0	14.38	18.99	35.47	41.01	1.14	0.65	33.08	16.60	3.47
100.0	14.38	18.99	34.39	40.01	1.14	0.65	34.12	16.57	3.45
200.0	14.34	19.01	34.23	38.25	1.15	0.66	33.31	16.31	3.43
300.0	14.31	19.01	39.60	37.80	1.15	0.66	33.25	16.35	3.57
400.0	14.27	18.99	37.35	35.72	1.15	0.66	35.77	16.58	3.58
500.0	14.23	19.00	38.31	35.66	1.15	0.67	32.57	16.48	3.60
600.0	14.19	19.01	35.28	33.92	1.16	0.67	32.93	16.54	3.58
700.0	14.14	19.03	33.87	33.17	1.16	0.67	33.91	16.55	3.60
800.0	14.11	19.03	33.47	31.87	1.16	0.68	34.73	16.53	3.54
900.0	14.05	19.07	32.14	29.96	1.17	0.68	33.56	16.27	3.57
1000.0	14.01	19.09	31.53	28.64	1.17	0.69	32.49	16.26	3.57
1200.0	13.92	19.13	30.18	26.59	1.18	0.70	33.53	16.54	3.52
1400.0	13.83	19.21	28.36	26.27	1.20	0.71	32.91	16.34	3.60
1600.0	13.73	19.29	27.41	25.64	1.21	0.72	34.04	16.49	3.58
1800.0	13.63	19.36	26.77	26.00	1.22	0.73	32.99	16.40	3.59
2000.0	13.53	19.47	25.55	26.67	1.24	0.74	32.01	16.04	3.61
2200.0	13.43	19.56	24.76	27.40	1.26	0.76	31.91	15.93	3.64
2400.0	13.33	19.70	23.93	28.59	1.28	0.77	30.04	15.69	3.83
2600.0	13.22	19.83	23.19	31.83	1.30	0.78	29.70	15.29	3.69
2800.0	13.12	19.96	22.37	34.17	1.32	0.80	29.71	14.90	3.81
3000.0	13.02	20.13	21.77	38.38	1.35	0.81	29.17	14.50	3.71
3200.0	12.94	20.25	20.88	38.76	1.37	0.82	28.33	14.14	3.74
3400.0	12.84	20.46	19.96	39.49	1.40	0.84	27.61	13.75	3.70
3600.0	12.73	20.68	19.28	37.36	1.44	0.85	26.89	13.37	3.81
3800.0	12.63	20.87	18.38	34.34	1.47	0.86	26.67	13.06	3.82
4000.0	12.53	21.07	17.69	34.62	1.50	0.87	26.00	12.69	3.77
4200.0	12.49	21.27	16.82	37.47	1.53	0.89	25.50	12.32	3.85
4400.0	12.39	21.49	15.95	36.12	1.57	0.90	25.43	12.09	3.94
4600.0	12.27	21.84	15.94	31.32	1.64	0.91	24.94	11.73	3.96
4800.0	12.18	21.91	15.06	33.19	1.65	0.92	24.38	11.38	3.99
5000.0	12.20	22.35	14.36	30.44	1.71	0.94	23.95	10.99	4.04
5200.0	12.03	22.33	13.85	32.57	1.72	0.95	23.53	10.49	4.07
5400.0	12.09	22.78	13.62	27.17	1.78	0.95	22.74	10.01	4.25
5600.0	12.08	23.05	12.73	25.76	1.82	0.97	22.85	9.95	4.21
5800.0	12.05	23.13	12.64	25.18	1.83	0.97	21.88	9.33	4.27
6000.0	12.13	23.58	12.08	22.70	1.89	0.98	21.45	8.92	4.26
6200.0	12.24	23.91	11.61	21.59	1.92	0.99	20.97	8.60	4.31
6400.0	12.11	23.48	11.99	23.28	1.87	0.98	20.43	8.26	4.38
6600.0	12.24	23.73	11.88	22.13	1.89	0.98	20.08	7.88	4.36
6800.0	12.28	24.21	11.54	21.39	1.97	0.99	19.46	7.45	4.44
7000.0	12.41	23.96	12.16	21.39	1.91	0.97	19.04	7.13	4.42



## Typical Performance Data

### Definitions:

Input Return Loss = -S11 (dB)

Gain(Power Gain) = S21 (dB)

Reverse Isolation = -S12 (dB)

Output Return Loss = -S22 (dB)

TEST CONDITIONS: Id = 78mA, Vd = 4.83V @ Temperature = -45degC

FREQ	Gain	Isolation	Input Return Loss	Output Return Loss	Stability		IP-3 Output	1dB Comp. Output	Noise Figure
					K	Measure			
(MHz)	(dB)	(dB)	(dB)	(dB)	K	Measure	(dBm)	(dBm)	(dB)
20.0	14.57	19.12	39.41	37.17	1.14	0.65	34.05	17.36	3.71
30.0	14.59	19.13	44.80	37.85	1.14	0.65	34.11	17.59	3.72
40.0	14.58	19.12	55.16	37.96	1.14	0.65	38.12	18.12	3.73
50.0	14.58	19.13	47.42	38.67	1.14	0.65	37.74	18.20	3.74
60.0	14.57	19.08	44.40	39.98	1.14	0.65	41.19	19.19	3.67
70.0	14.56	19.11	42.94	41.35	1.14	0.65	37.84	19.08	3.71
80.0	14.56	19.13	44.03	42.76	1.14	0.65	33.13	19.16	3.67
90.0	14.56	19.12	46.27	43.82	1.14	0.65	35.01	19.12	3.67
100.0	14.55	19.12	43.94	45.38	1.14	0.65	40.68	19.08	3.65
200.0	14.51	19.12	42.66	42.44	1.14	0.65	40.23	19.26	3.64
300.0	14.48	19.14	38.22	32.77	1.15	0.66	37.78	19.35	3.72
400.0	14.43	19.16	35.08	30.75	1.15	0.66	37.52	19.38	3.79
500.0	14.39	19.15	34.62	30.61	1.15	0.66	37.07	19.45	3.81
600.0	14.35	19.16	32.99	29.65	1.16	0.67	41.80	19.46	3.79
700.0	14.31	19.16	32.52	29.55	1.16	0.67	38.81	19.39	3.80
800.0	14.27	19.16	32.31	28.98	1.16	0.67	44.18	19.38	3.72
900.0	14.22	19.19	30.90	27.44	1.17	0.68	37.93	19.36	3.50
1000.0	14.17	19.22	30.25	26.31	1.17	0.68	39.49	19.27	3.70
1200.0	14.08	19.25	28.34	24.57	1.18	0.69	37.90	19.14	3.66
1400.0	13.99	19.34	26.86	24.23	1.19	0.70	41.33	19.00	3.77
1600.0	13.88	19.39	26.08	23.65	1.20	0.71	36.40	18.66	3.77
1800.0	13.79	19.50	25.72	23.96	1.22	0.73	37.54	18.19	3.76
2000.0	13.69	19.60	24.86	24.51	1.24	0.74	36.96	18.06	3.77
2200.0	13.59	19.71	24.29	25.10	1.26	0.75	34.80	17.74	3.83
2400.0	13.49	19.85	23.78	26.06	1.28	0.77	33.12	17.22	3.84
2600.0	13.38	19.97	23.38	28.27	1.30	0.78	33.27	16.79	3.90
2800.0	13.28	20.12	22.79	30.07	1.32	0.80	31.57	16.41	3.99
3000.0	13.18	20.24	22.37	32.71	1.34	0.81	31.26	16.08	3.99
3200.0	13.10	20.40	21.48	33.66	1.37	0.82	30.67	15.73	3.95
3400.0	13.00	20.59	20.57	34.19	1.40	0.83	29.58	15.29	3.96
3600.0	12.90	20.81	19.90	34.86	1.43	0.85	28.74	14.89	4.08
3800.0	12.80	20.98	19.01	33.09	1.46	0.86	28.45	14.58	4.05
4000.0	12.71	21.18	18.24	33.07	1.50	0.87	28.06	14.20	4.06
4200.0	12.67	21.41	17.43	36.02	1.53	0.88	27.41	13.87	4.11
4400.0	12.58	21.61	16.54	37.29	1.56	0.90	27.33	13.68	4.21
4600.0	12.45	21.99	16.64	31.36	1.64	0.91	26.99	13.36	4.21
4800.0	12.38	22.05	15.67	34.43	1.65	0.92	26.78	13.01	4.27
5000.0	12.41	22.48	14.99	32.07	1.70	0.93	25.92	12.62	4.28
5200.0	12.25	22.49	14.41	35.68	1.72	0.94	25.57	12.10	4.35
5400.0	12.34	22.90	14.27	28.90	1.77	0.95	24.89	11.62	4.52
5600.0	12.34	23.15	13.33	27.16	1.80	0.96	24.96	11.59	4.52
5800.0	12.31	23.22	13.21	26.36	1.82	0.96	24.00	10.93	4.57
6000.0	12.41	23.73	12.71	23.73	1.88	0.97	23.61	10.51	4.58
6200.0	12.54	24.06	12.29	22.35	1.91	0.98	23.03	10.19	4.60
6400.0	12.38	23.62	12.44	24.14	1.86	0.97	22.64	9.85	4.69
6600.0	12.55	23.85	12.54	22.89	1.87	0.97	22.22	9.45	4.68
6800.0	12.65	24.38	12.17	22.28	1.95	0.98	21.44	9.02	4.77
7000.0	12.78	24.08	12.77	21.75	1.88	0.96	21.05	8.69	4.81

## Typical Performance Data

### Definitions:

Input Return Loss = -S11 (dB)

Gain(Power Gain) = S21 (dB)

Reverse Isolation = -S12 (dB)

Output Return Loss = -S22 (dB)

TEST CONDITIONS: Id = 65mA, Vd = 4.28V @ Temperature = +85degC

FREQ	Gain	Isolation	Input Return Loss	Output Return Loss	Stability		IP-3 Output	1dB Comp. Output	Noise Figure
					K	Measure			
(MHz)	(dB)	(dB)	(dB)	(dB)	K	Measure	(dBm)	(dBm)	(dB)
20.0	14.34	18.98	42.09	43.89	1.15	0.66	35.09	15.99	4.60
30.0	14.35	18.97	49.17	43.52	1.14	0.65	34.39	16.21	4.70
40.0	14.34	19.02	46.96	41.53	1.15	0.66	33.16	16.61	4.68
50.0	14.34	19.02	62.62	41.07	1.15	0.66	34.69	16.67	4.69
60.0	14.33	19.01	47.96	40.03	1.15	0.66	36.02	17.76	4.62
70.0	14.32	19.02	42.99	39.22	1.15	0.66	33.60	17.66	4.66
80.0	14.32	19.00	41.14	38.31	1.15	0.66	36.70	17.72	4.62
90.0	14.32	19.02	40.02	36.94	1.15	0.66	35.83	17.69	4.64
100.0	14.31	19.01	40.00	36.18	1.15	0.66	34.23	17.65	4.60
200.0	14.26	19.04	34.72	33.20	1.15	0.67	33.86	17.73	4.64
300.0	14.22	19.03	36.19	34.62	1.16	0.67	34.73	17.77	4.74
400.0	14.16	19.05	36.42	35.63	1.16	0.68	36.01	17.79	4.83
500.0	14.11	19.05	34.65	34.20	1.17	0.68	34.05	17.78	4.87
600.0	14.05	19.09	33.35	32.69	1.17	0.69	33.14	17.70	4.87
700.0	14.01	19.11	32.81	32.04	1.18	0.69	35.41	17.64	4.89
800.0	13.96	19.14	32.29	31.25	1.18	0.70	33.80	17.59	4.83
900.0	13.90	19.16	31.64	30.54	1.19	0.70	32.49	17.56	4.87
1000.0	13.85	19.20	31.67	29.76	1.19	0.71	31.99	17.45	4.80
1200.0	13.75	19.25	30.60	28.42	1.21	0.72	33.82	17.26	4.84
1400.0	13.64	19.36	29.43	27.55	1.22	0.73	32.91	17.05	4.93
1600.0	13.53	19.43	28.55	27.14	1.24	0.74	32.24	16.73	4.91
1800.0	13.41	19.56	27.50	26.93	1.26	0.76	30.53	16.21	4.97
2000.0	13.30	19.64	26.36	27.40	1.28	0.77	30.24	16.01	4.99
2200.0	13.19	19.78	25.40	28.62	1.30	0.78	29.79	15.65	5.02
2400.0	13.07	19.92	24.61	30.43	1.32	0.80	28.99	15.12	5.06
2600.0	12.95	20.07	23.58	32.61	1.35	0.81	28.35	14.64	5.13
2800.0	12.83	20.24	22.59	35.22	1.38	0.82	27.24	14.18	5.19
3000.0	12.71	20.43	21.53	39.81	1.41	0.84	26.88	13.78	5.21
3200.0	12.61	20.60	20.34	40.74	1.44	0.85	26.01	13.42	5.21
3400.0	12.48	20.82	19.39	38.64	1.48	0.86	25.36	13.05	5.24
3600.0	12.36	21.04	18.43	35.20	1.52	0.88	25.02	12.59	5.36
3800.0	12.27	21.31	17.31	33.72	1.57	0.89	24.43	12.18	5.38
4000.0	12.14	21.52	16.47	31.95	1.61	0.90	23.83	11.77	5.37
4200.0	12.04	21.79	15.62	30.85	1.66	0.92	23.66	11.36	5.46
4400.0	11.93	22.08	14.88	29.86	1.71	0.93	23.27	11.04	5.54
4600.0	11.79	22.20	14.08	29.93	1.75	0.95	22.75	10.68	5.62
4800.0	11.69	22.49	13.48	28.30	1.80	0.96	22.36	10.29	5.71
5000.0	11.57	22.74	12.91	26.96	1.86	0.97	21.60	9.74	5.76
5200.0	11.40	22.85	12.66	26.98	1.90	0.98	21.51	9.41	5.79
5400.0	11.42	23.27	12.44	24.11	1.97	0.98	20.66	8.79	5.98
5600.0	11.36	23.37	12.42	23.74	2.01	0.98	20.39	8.70	5.99
5800.0	11.24	23.79	11.58	22.62	2.09	1.00	19.88	8.26	6.05
6000.0	11.37	24.31	11.30	20.14	2.16	1.01	19.51	7.73	6.07
6200.0	11.25	23.82	11.72	21.67	2.10	1.00	18.95	7.42	6.17
6400.0	11.22	24.57	11.16	20.57	2.25	1.01	18.48	7.10	6.22
6600.0	11.27	24.76	11.30	19.86	2.29	1.01	18.11	6.71	6.22
6800.0	11.38	23.95	12.31	20.23	2.12	0.98	17.47	6.43	6.38
7000.0	11.35	23.85	12.38	18.90	2.11	0.98	17.27	6.01	6.33

## Typical Performance Data

### Definitions:

Input Return Loss = -S11 (dB)

Gain(Power Gain) = S21 (dB)

Reverse Isolation = -S12 (dB)

Output Return Loss = -S22 (dB)

TEST CONDITIONS: Id = 52mA, Vd = 4.16V @ Temperature = +85degC

FREQ	Gain	Isolation	Input Return Loss	Output Return Loss	Stability		IP-3 Output	1dB Comp. Output	Noise Figure
					K	Measure			
(MHz)	(dB)	(dB)	(dB)	(dB)	K	Measure	(dBm)	(dBm)	(dB)
20.0	14.22	18.94	47.55	43.42	1.15	0.66	31.96	14.94	4.52
30.0	14.23	18.90	43.50	45.70	1.15	0.66	39.70	15.06	4.57
40.0	14.22	18.92	40.06	48.36	1.15	0.66	35.24	15.11	4.56
50.0	14.21	18.88	40.48	51.06	1.15	0.66	35.23	15.18	4.58
60.0	14.20	18.88	42.76	49.24	1.15	0.66	34.27	16.47	4.49
70.0	14.20	18.89	45.88	49.92	1.15	0.66	30.99	16.44	4.56
80.0	14.19	18.92	51.90	47.99	1.15	0.66	31.43	16.40	4.49
90.0	14.19	18.93	60.37	46.01	1.15	0.66	32.88	16.41	4.51
100.0	14.19	18.91	58.88	44.78	1.15	0.66	31.26	16.38	4.52
200.0	14.14	18.92	38.35	38.60	1.16	0.67	31.92	16.22	4.49
300.0	14.09	18.94	38.43	41.67	1.16	0.67	31.95	16.23	4.76
400.0	14.04	18.94	37.07	42.17	1.16	0.68	32.95	16.34	4.71
500.0	13.99	18.97	35.26	38.48	1.17	0.68	32.60	16.26	4.74
600.0	13.93	19.00	33.54	35.90	1.18	0.69	32.46	16.27	4.74
700.0	13.89	18.99	32.96	34.69	1.18	0.69	32.01	16.23	4.76
800.0	13.84	19.03	32.28	33.41	1.18	0.70	32.01	16.21	4.75
900.0	13.78	19.05	31.65	32.56	1.19	0.70	31.50	16.04	4.72
1000.0	13.73	19.09	31.44	31.63	1.20	0.71	30.46	15.98	4.72
1200.0	13.63	19.15	30.62	30.16	1.21	0.72	32.39	16.06	4.78
1400.0	13.53	19.25	29.58	29.29	1.22	0.73	31.03	15.87	4.79
1600.0	13.41	19.33	28.69	28.91	1.24	0.74	30.68	15.75	4.81
1800.0	13.30	19.43	27.56	28.83	1.26	0.76	30.51	15.44	4.84
2000.0	13.19	19.54	26.30	29.47	1.28	0.77	28.75	15.15	4.83
2200.0	13.08	19.69	25.25	31.00	1.30	0.78	28.90	14.83	4.88
2400.0	12.96	19.80	24.25	33.41	1.32	0.80	27.54	14.35	4.85
2600.0	12.84	19.97	23.19	36.72	1.35	0.81	27.05	13.86	4.99
2800.0	12.71	20.16	22.14	41.02	1.38	0.83	26.27	13.39	5.09
3000.0	12.60	20.33	21.09	45.63	1.41	0.84	25.88	12.96	5.03
3200.0	12.49	20.50	19.92	40.72	1.44	0.85	24.86	12.57	5.05
3400.0	12.36	20.72	18.96	37.13	1.48	0.87	24.51	12.22	5.09
3600.0	12.24	20.97	18.03	33.32	1.53	0.88	24.01	11.79	5.14
3800.0	12.14	21.17	16.95	31.86	1.56	0.89	23.61	11.36	5.22
4000.0	12.01	21.45	16.12	30.49	1.62	0.91	22.98	10.93	5.22
4200.0	11.91	21.66	15.28	29.47	1.65	0.92	22.58	10.55	5.30
4400.0	11.80	21.99	14.57	28.45	1.72	0.94	22.22	10.19	5.40
4600.0	11.65	22.14	13.78	28.45	1.75	0.95	21.73	9.84	5.41
4800.0	11.55	22.43	13.18	27.01	1.81	0.96	21.29	9.43	5.48
5000.0	11.42	22.68	12.65	25.84	1.87	0.97	20.49	8.90	5.58
5200.0	11.25	22.80	12.41	25.63	1.91	0.98	20.42	8.57	5.62
5400.0	11.26	23.20	12.18	23.38	1.98	0.99	19.53	7.94	5.83
5600.0	11.16	23.18	12.14	23.44	2.00	0.99	19.27	7.87	5.79
5800.0	11.08	23.70	11.28	21.73	2.09	1.01	18.78	7.42	5.84
6000.0	11.18	24.18	11.07	19.65	2.16	1.01	18.36	6.90	5.86
6200.0	11.05	23.74	11.41	21.07	2.11	1.00	17.84	6.61	5.98
6400.0	11.03	24.45	10.89	19.99	2.26	1.02	17.45	6.27	5.97
6600.0	11.06	24.63	11.06	19.43	2.30	1.01	17.06	5.92	5.99
6800.0	11.14	23.85	12.00	20.20	2.14	0.99	16.42	5.61	6.13
7000.0	11.12	23.70	12.19	18.87	2.12	0.98	16.23	5.16	6.09

## Typical Performance Data

### Definitions:

Input Return Loss = -S11 (dB)

Gain(Power Gain) = S21 (dB)

Reverse Isolation = -S12 (dB)

Output Return Loss = -S22 (dB)

TEST CONDITIONS: Id = 78mA, Vd = 4.41V @ Temperature = +85degC

FREQ	Gain	Isolation	Input Return Loss	Output Return Loss	Stability		IP-3 Output	1dB Comp. Output	Noise Figure
					K	Measure			
(MHz)	(dB)	(dB)	(dB)	(dB)	K	Measure	(dBm)	(dBm)	(dB)
20.0	14.42	18.98	36.76	37.72	1.14	0.65	33.27	16.24	4.73
30.0	14.43	19.06	40.00	37.10	1.15	0.66	33.61	16.48	4.79
40.0	14.42	19.05	40.43	36.09	1.15	0.66	36.28	17.07	4.80
50.0	14.42	19.09	42.16	35.64	1.15	0.66	37.70	17.11	4.83
60.0	14.41	19.07	39.30	35.24	1.15	0.66	39.67	18.05	4.73
70.0	14.40	19.08	37.53	34.81	1.15	0.66	37.71	17.93	4.79
80.0	14.40	19.09	36.07	34.27	1.15	0.66	36.87	18.03	4.77
90.0	14.39	19.07	35.51	33.44	1.15	0.66	35.99	17.99	4.74
100.0	14.39	19.09	35.22	32.96	1.15	0.66	38.30	17.94	4.74
200.0	14.34	19.12	32.28	30.62	1.15	0.67	37.46	18.18	4.72
300.0	14.29	19.12	34.00	31.88	1.16	0.67	36.29	18.33	4.93
400.0	14.23	19.13	34.27	32.60	1.16	0.68	38.56	18.38	4.94
500.0	14.18	19.16	33.08	31.80	1.17	0.68	39.75	18.46	4.96
600.0	14.13	19.17	32.13	30.68	1.17	0.69	38.59	18.44	4.99
700.0	14.08	19.19	31.88	30.22	1.18	0.69	38.67	18.37	5.00
800.0	14.03	19.21	31.45	29.67	1.18	0.70	37.92	18.30	4.93
900.0	13.97	19.22	31.02	29.08	1.19	0.70	35.40	18.42	4.98
1000.0	13.92	19.27	31.03	28.45	1.19	0.71	33.45	18.23	4.99
1200.0	13.82	19.33	30.00	27.22	1.21	0.72	35.54	17.83	5.04
1400.0	13.71	19.42	28.94	26.44	1.22	0.73	34.54	17.62	5.05
1600.0	13.60	19.51	28.13	25.98	1.24	0.74	34.30	17.22	5.05
1800.0	13.48	19.61	27.13	25.86	1.26	0.75	31.79	16.65	5.09
2000.0	13.37	19.70	26.03	26.22	1.28	0.77	31.90	16.53	5.09
2200.0	13.26	19.82	25.30	27.22	1.30	0.78	30.01	16.17	5.18
2400.0	13.14	19.99	24.59	28.74	1.32	0.79	29.65	15.63	5.15
2600.0	13.02	20.15	23.63	30.59	1.35	0.81	29.23	15.18	5.27
2800.0	12.90	20.30	22.73	32.76	1.38	0.82	28.15	14.75	5.38
3000.0	12.79	20.49	21.73	35.73	1.41	0.84	27.62	14.37	5.30
3200.0	12.68	20.68	20.50	37.31	1.44	0.85	27.04	14.02	5.36
3400.0	12.55	20.89	19.54	37.38	1.48	0.86	26.44	13.66	5.40
3600.0	12.43	21.14	18.61	34.80	1.53	0.88	25.74	13.23	5.52
3800.0	12.34	21.32	17.52	33.84	1.56	0.89	25.48	12.79	5.51
4000.0	12.22	21.58	16.64	32.18	1.61	0.90	24.75	12.40	5.56
4200.0	12.12	21.83	15.79	31.27	1.65	0.92	24.49	12.01	5.66
4400.0	12.02	22.14	15.03	30.29	1.71	0.93	24.10	11.71	5.72
4600.0	11.87	22.31	14.28	30.43	1.75	0.94	23.68	11.37	5.81
4800.0	11.78	22.59	13.66	28.94	1.81	0.96	23.33	10.94	5.88
5000.0	11.66	22.79	13.07	27.69	1.85	0.97	22.51	10.44	5.96
5200.0	11.47	22.85	12.89	28.22	1.89	0.98	22.37	10.14	6.01
5400.0	11.52	23.37	12.60	24.51	1.98	0.98	21.48	9.52	6.18
5600.0	11.53	23.65	12.53	23.16	2.03	0.98	21.36	9.43	6.18
5800.0	11.33	23.69	11.91	23.59	2.06	1.00	20.75	8.98	6.29
6000.0	11.48	24.40	11.47	20.43	2.16	1.00	20.36	8.48	6.28
6200.0	11.41	23.80	12.00	21.73	2.07	0.99	19.76	8.14	6.36
6400.0	11.37	24.53	11.42	20.73	2.22	1.01	19.32	7.80	6.43
6600.0	11.40	24.83	11.51	20.20	2.28	1.01	18.99	7.43	6.47
6800.0	11.55	24.01	12.52	19.84	2.10	0.98	18.34	7.11	6.57
7000.0	11.49	24.01	12.49	18.77	2.11	0.97	18.13	6.72	6.60

## Typical Performance Curves

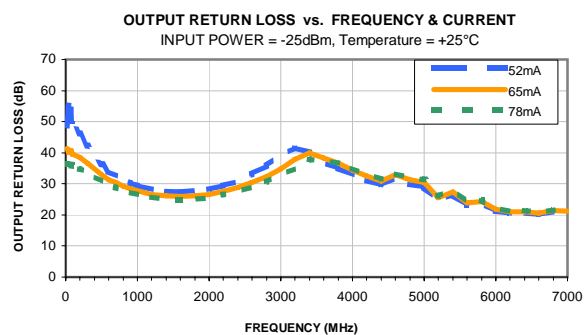
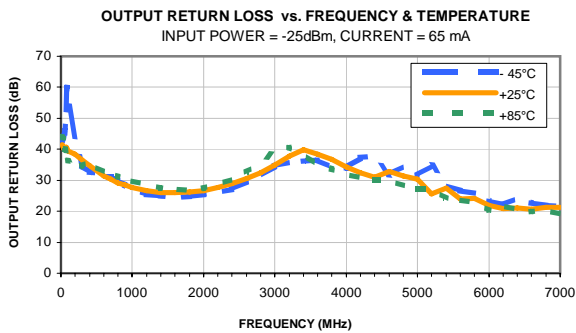
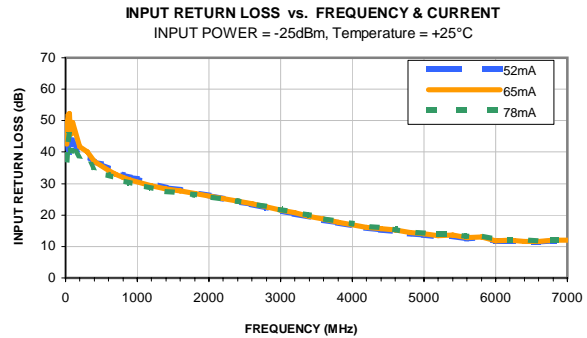
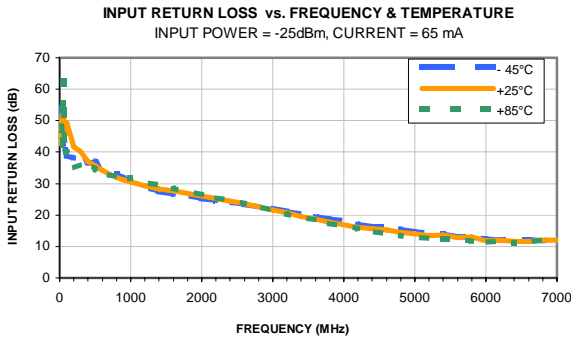
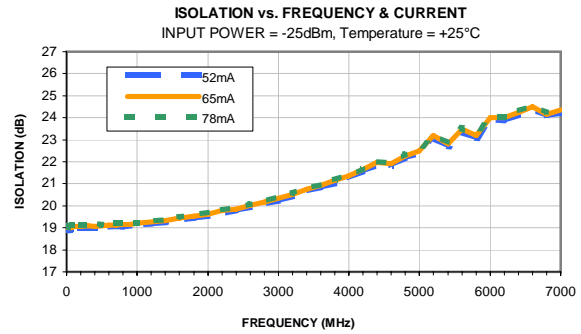
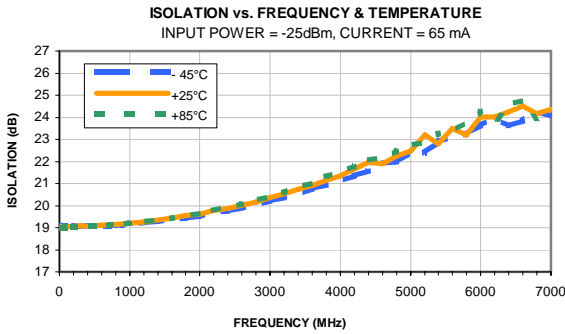
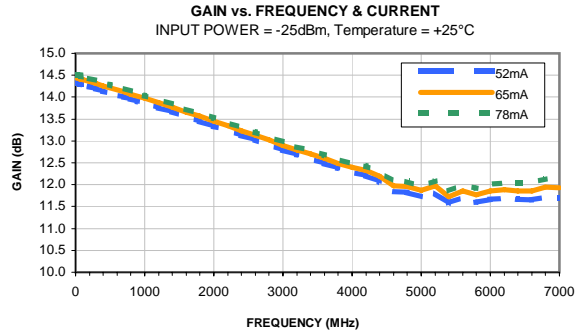
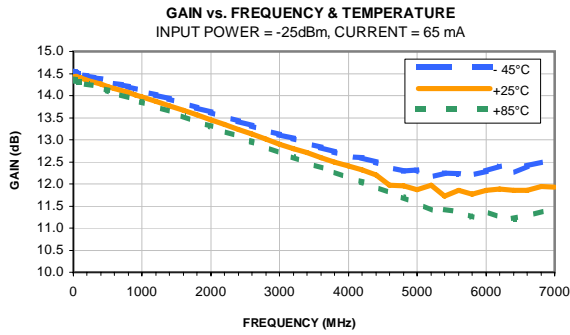

## Typical Performance Curves

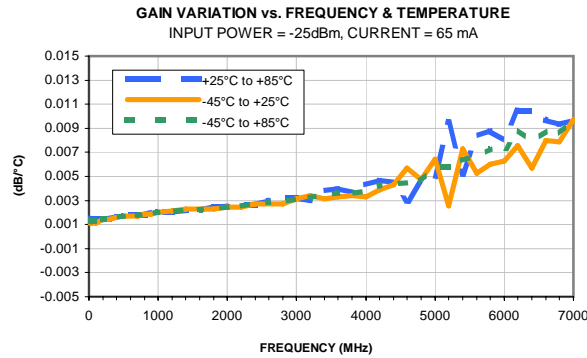
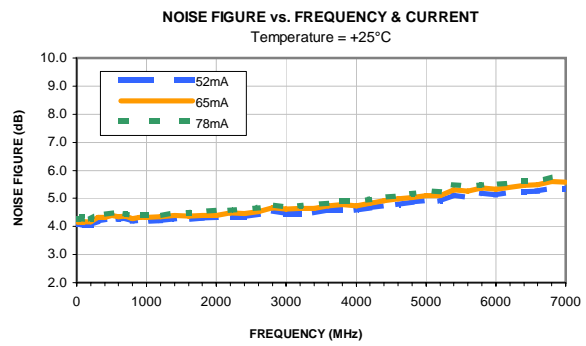
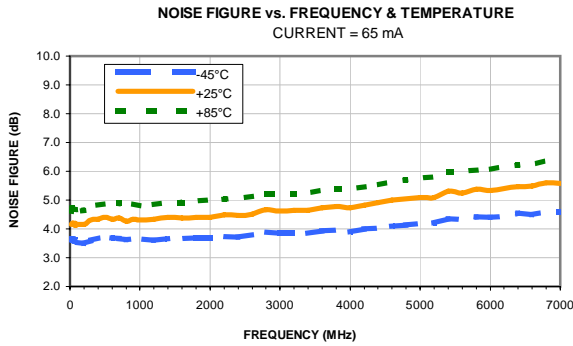
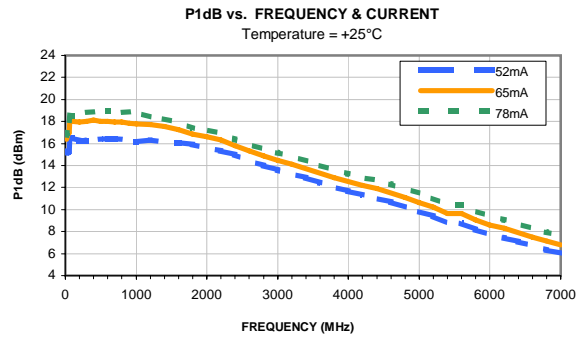
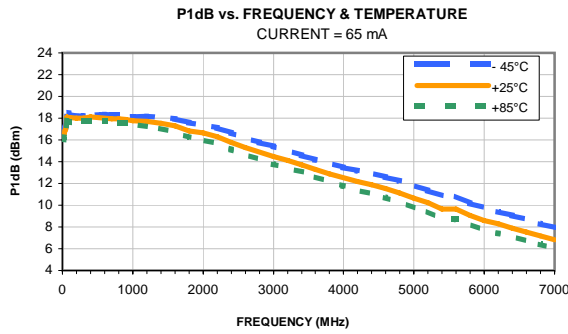
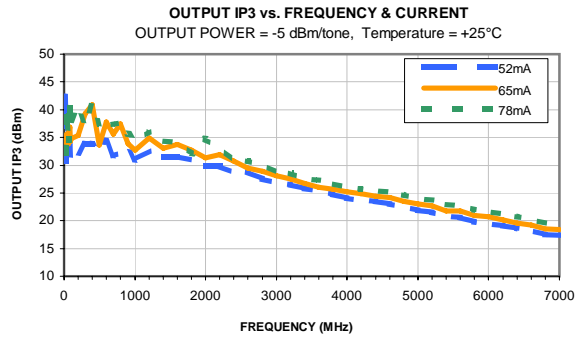
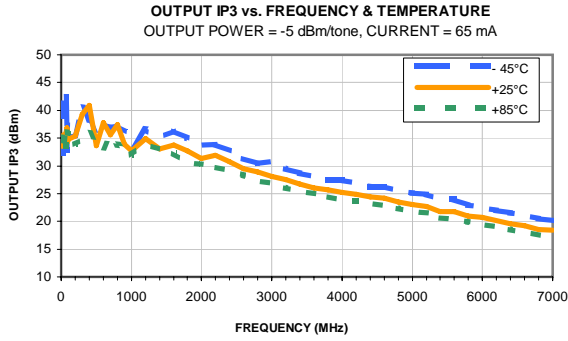



### Outline Dimensions

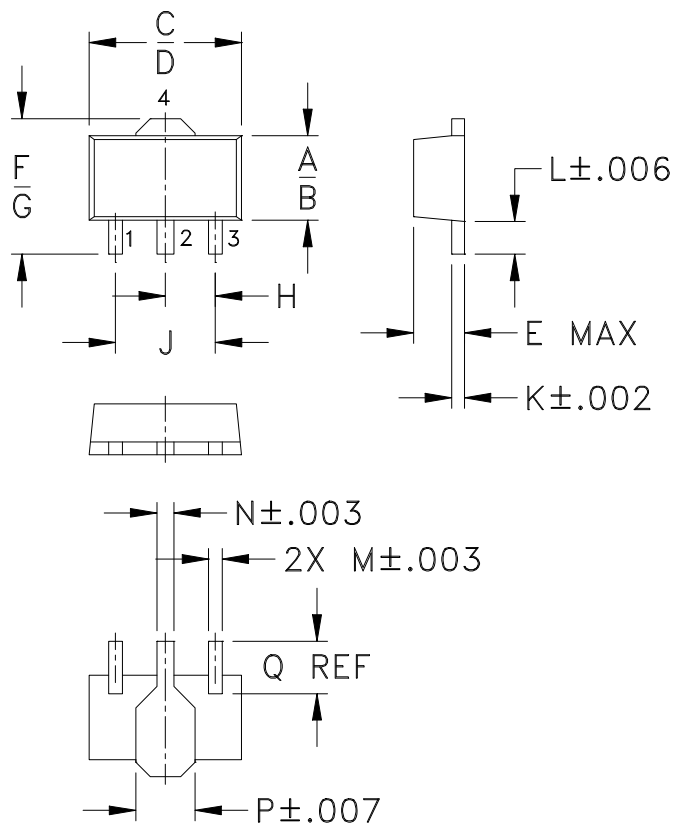

### PCB Land Pattern

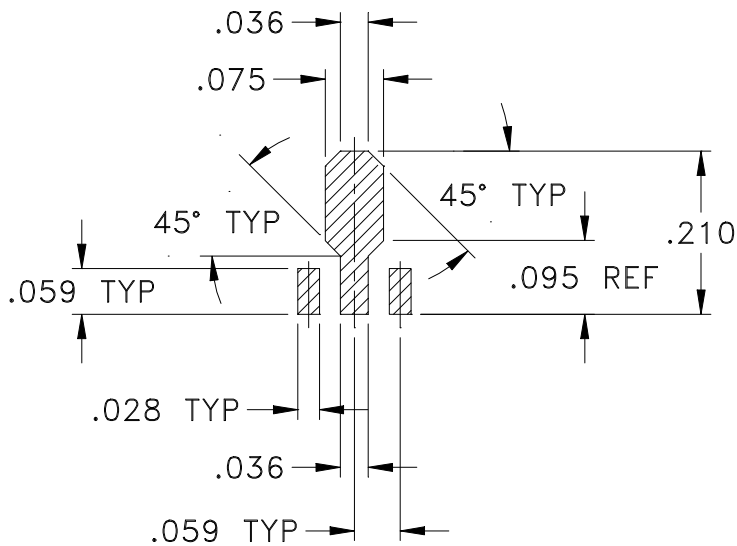

Suggested Layout,  
Tolerance to be within  $\pm .002$

CASE #	A	B	C	D	E	F	G	H	J	K	L	M
DF782	.102 (2.59)	.090 (2.29)	.181 (4.60)	.173 (4.39)	.063 (1.60)	.167 (4.24)	.155 (3.94)	.059 (1.50)	.118 (3.00)	.015 (0.38)	.041 (1.04)	.016 (0.41)

CASE #	N	P	Q	WT. GRAM
DF782	.019 (0.48)	.065 (1.65)	.062 (1.57)	.2

Dimensions are in inches (mm). Tolerances: 2 Pl.  $\pm .01$ ; 3Pl.  $\pm .005$

#### Notes:

- Case material: Plastic.
- Termination finish:  
 For RoHS Case Styles: Tin-Silver alloy plate over Nickel barrier or Matte-Tin.  
 All models, (+) suffix. See model Data sheet.  
 For RoHS-5 Case Styles: Tin-Lead plate. All models, no (+) suffix.



INTERNET <http://www.minicircuits.com>

P.O. Box 350166, Brooklyn, New York 11235-0003 (718) 934-4500 Fax (718) 332-4661

Distribution Centers NORTH AMERICA 800-654-7949 • 417-335-5935 • Fax 417-335-5945 • EUROPE 44-1252-832600 • Fax 44-1252-837010

Mini-Circuits ISO 9001 & ISO 14001 Certified



# Tape & Reel Packaging TR-F55

## DEVICE ORIENTATION IN T&R

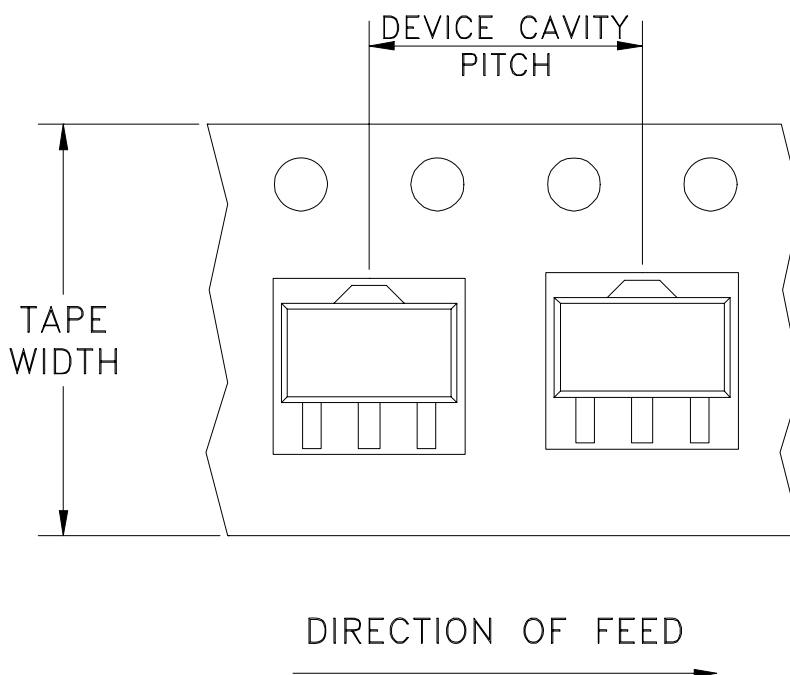

Tape Width, mm	Device Cavity Pitch, mm	Reel Size, inches	Devices per Reel	
12	8	7	Small quantity standard (see note)	20
				50
				100
				200
				500
			Standard	1000

Note: Please consult individual model data sheet to determine device per reel availability.

Mini-Circuits carrier tape materials provide protection from ESD (Electro-Static Discharge) during handling and transportation. Tapes are static dissipative and comply with industry standards EIA-481/EIA-541.

Go to: [www.minicircuits.com/pages/pdfs/tape.pdf](http://www.minicircuits.com/pages/pdfs/tape.pdf)



INTERNET <http://www.minicircuits.com>

P.O. Box 350166, Brooklyn, New York 11235-0003 (718) 934-4500 Fax (718) 332-4661

Distribution Centers NORTH AMERICA 800-654-7949 • 417-335-5935 • Fax 417-335-5945 • EUROPE 44-1252-832600 • Fax 44-1252-837010

Mini-Circuits ISO 9001 & ISO 14001 Certified

THIRD ANGLE PROJECTION

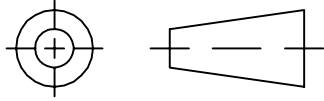

REVISIONS

REV	ECN No.	DESCRIPTION	DATE	DR	AUTH
A	M76190	CHANGED DISCRIPTION	04/01	GF	CT
B	M82575	UPDATED DRAWING	08/05/02	AV	LC
C	M102713	ADDED NOTE 2 & "...WITH SMOBC"	01/17/06	MMG	IL
D	M108434	UPDATED DRAWING PER TB-409+	11/14/06	PW	IG

SUGGESTED MOUNTING CONFIGURATION  
FOR DF782 CASE STYLE, "mz" PIN CONNECTION

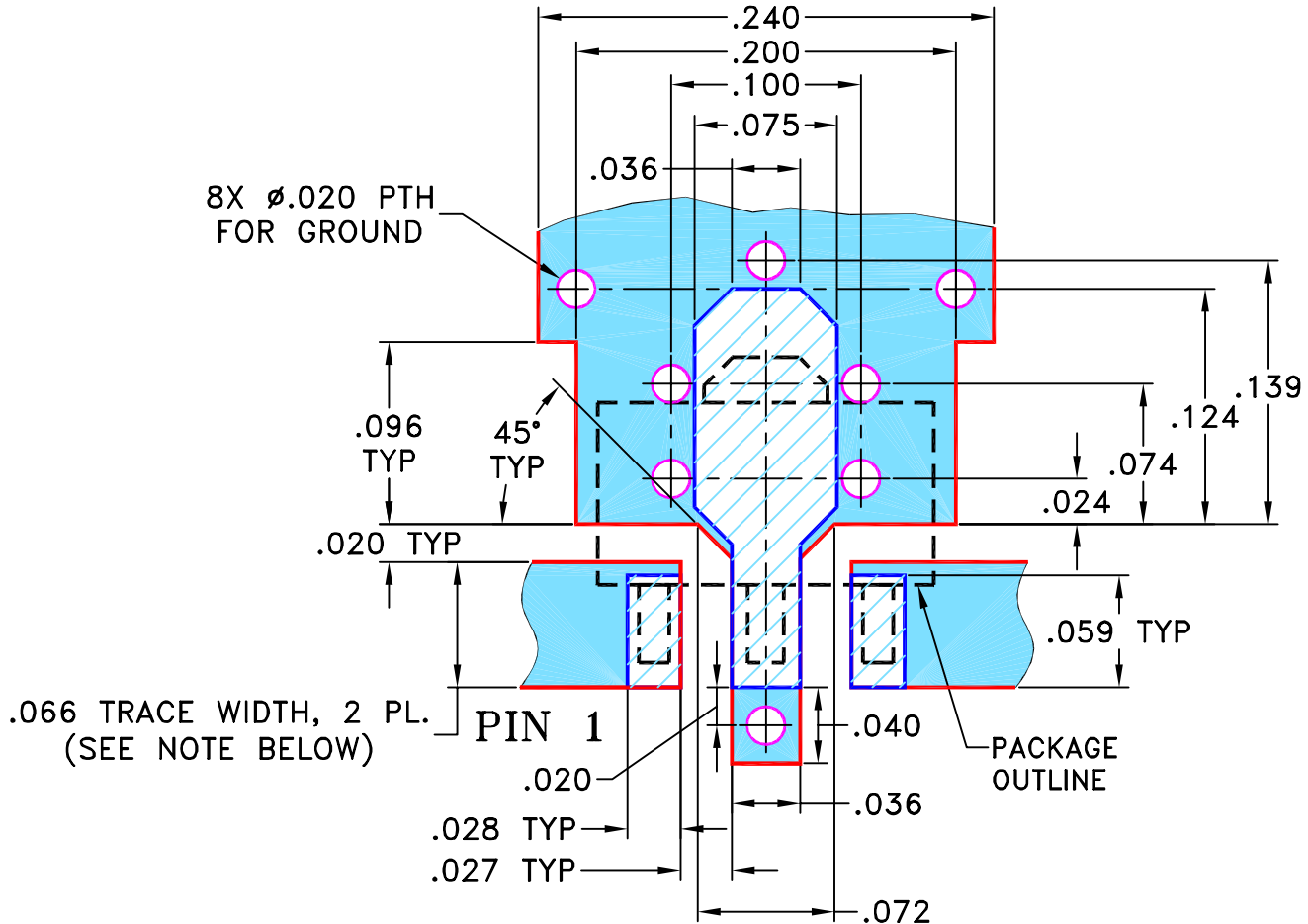

- NOTES:** 1. TRACE WIDTH IS SHOWN FOR ROGERS R04350B WITH DIELECTRIC THICKNESS .030" ± .002"; COPPER: 1/2 OZ. EACH SIDE. FOR OTHER MATERIALS TRACE WIDTH MAY NEED TO BE MODIFIED.  
2. BOTTOM SIDE OF THE PCB IS CONTINUOUS GROUND PLANE.



DENOTES PCB COPPER LAYOUT WITH SMOBC (SOLDER MASK OVER BARE COPPER)



DENOTES COPPER LAND PATTERN FREE OF SOLDER MASK

UNLESS OTHERWISE SPECIFIED

INITIALS

DATE

DIMENSIONS ARE IN INCHES

TOLERANCES ON:

2 PL DECIMALS ±

3 PL DECIMALS ± .005

ANGLES ±

FRACTIONS ±



DRAWN

AV

01/15/01

CHECKED

YB

01/23/01

APPROVED

DB

01/23/01

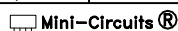

THIS DOCUMENT AND ITS CONTENTS ARE THE PROPERTY OF MINI-CIRCUITS. EXCEPT FOR USE EXPRESSLY GRANTED, IN WRITING, TO ITS VENDORS, VENDEE AND THE UNITED STATES GOVERNMENT, MINI-CIRCUITS RESERVES ALL PROPRIETARY DESIGN, USE, MANUFACTURING AND REPRODUCTION RIGHTS THERETO. THESE CONTENTS SHALL NOT BE USED, DUPLICATED OR DISCLOSED TO ANY OUTSIDE PARTY, IN WHOLE OR IN PART, WITHOUT WRITTEN PERMISSION OF MINI-CIRCUITS.

ASHEETA1.DWG REV:A DATE:01/12/95



Mini-Circuits®

13 Neptune Avenue  
Brooklyn NY 11235

PL, mz, DF782, GALI, TB-409-XXX+

SIZE

A

CODE IDENT

15542

DRAWING NO:

98-PL-019

REV:

D

FILE:

98PL019

SCALE:

10:1

SHEET:

1 OF 1

# Evaluation Board and Circuit

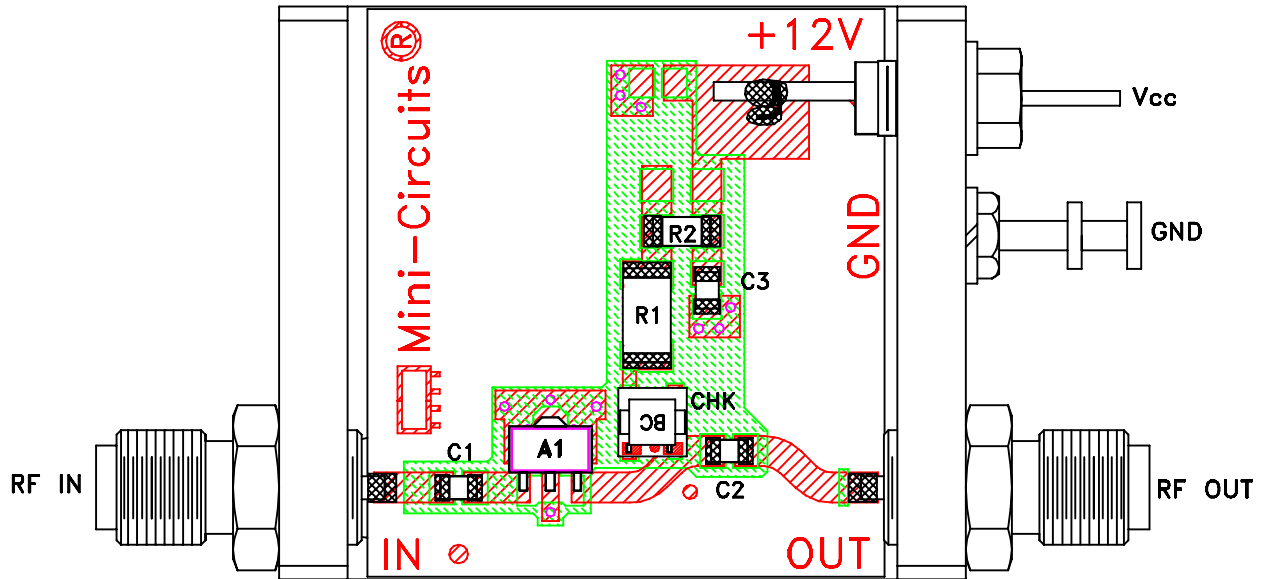

TB-409-49+

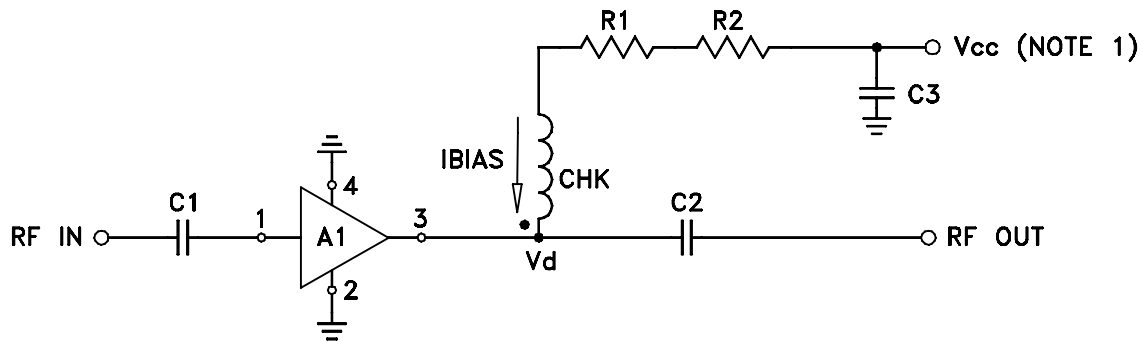

COMPONENT	VALUE
A1	Gali-49(+)
C1 (NOTE 4)	2400 pF
C2 (NOTE 4)	2400 pF
C3 (bypass)	0.1 uF
R1	100 Ohms, 0.75W
R2	8.25 Ohms, 0.25W
CHK	Mini-Circuits TCCH-80+

## Schematic Diagram

### NOTE:

1. Vcc voltage:  $+12 \pm 0.2V$ .
2. SMA Female connectors.
3. PCB material: Rogers RO4350 or equivalent, dielectric constant=3.5, dielectric thickness=.030 inch.
4. Capacitors, C1 & C2 should be free of resonance up to the highest frequency specified.

 **Mini-Circuits®**

All Mini-Circuits products are manufactured under exacting quality assurance and control standards, and are capable of meeting published specifications after being subjected to any or all of the following physical and environmental test.

Specification	Test/Inspection Condition	Reference/Spec
Operating Temperature	-45° to 85°C or -40° to 85°C Ambient Environment	Individual Model Data Sheet
Storage Temperature	-65° to 150° C Ambient Environment	Individual Model Data Sheet
Thermal Shock	-55° to 100°C, 100 cycles	MIL-STD-202, Method 107, Condition A-3, except +100°C
Mechanical Shock	1.5Kg, 0.5 ms, 5 shock pulses, Y1 direction only	MIL-STD-883, Method 2002, Condition B, except Y1 direction only
Vibration (Variable Frequency)	50g peak	MIL-STD-883, Method 2007, Condition B
Autoclave	15 psig, 100% RH, 121°C, 96 hours	JESD22-A102, Condition C
HAST	130°C, 85% RH, 96 hours	JESD22-A110
Solderability	10X Magnification	J-STD-002, Para 4.2.5, Test S, 95% Coverage
Solder Reflow Heat	Sn-Pb Eutetic Process: 240°C peak Pb-Free Process: 260°C peak	J-STD-020, Table 4-1, 4-2 and 5-2; Figure 5-1
Moisture Sensitivity: Level 1	Bake at 125°C for 24 hours Soak at 85°C/85% RH for 168 hours, Reflow 3 cycles at 260°C peak	J-STD-020
Marking Resistance to Solvents	Isopropyl alcohol + mineral spirits at 25°C; terpene defluxer at 25°C; distilled water + proylene glycol monomethyl ether +	MIL-STD-202, Method 215



All Mini-Circuits products are manufactured under exacting quality assurance and control standards, and are capable of meeting published specifications after being subjected to any or all of the following physical and environmental test.

<b>Specification</b>	<b>Test/Inspection Condition</b>	<b>Reference/Spec</b>
	monoethanolamine at 63°C to 70°C	