

# Coaxial Fixed Attenuator

## HAT-10-75+

75Ω 0.5W 10dB DC to 2000 MHz

### Maximum Ratings

Operating Temperature	-45°C to 100°C
Storage Temperature	-55°C to 100°C

Permanent damage may occur if any of these limits are exceeded.



Generic photo used for illustration purposes only

CASE STYLE: FF747

Connectors	Model
BNC Male-BNC Female	HAT-10-75+

### +RoHS Compliant

The +Suffix identifies RoHS Compliance. See our web site for RoHS Compliance methodologies and qualifications

### Features

- excellent VSWR, 1.04:1 typ.
- excellent flatness, 0.05 dB typ. to 2000 MHz
- usable to 4000 MHz
- rugged unibody construction

### Applications

- cable tv
- instrumentation
- DS3 signal

### Outline Drawing

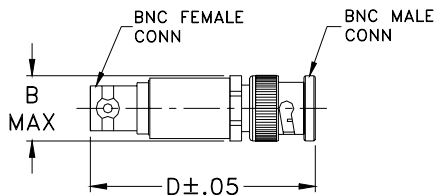

### Outline Dimensions (inch/mm)

B	D	wt
.62	1.94	grams
15.75	49.28	30.0

### Electrical Specifications

FREQ. RANGE (MHz)	ATTENUATION (dB)						VSWR (:1)						MAX. INPUT POWER† (W)	
	Flatness*													
	DC-0.5 GHz		DC-1 GHz		DC-2 GHz		DC-0.5 GHz		DC-1 GHz		DC-2 GHz			
$f_L-f_U$	Nom.	Typ.	Max.	Typ.	Max.	Typ.	Max.	Typ.	Max.	Typ.	Max.	Typ.	Max.	
DC-2000	10±0.2	0.05	0.15	0.05	0.20	0.05	0.20	1.03	1.2	1.04	1.2	1.1	1.3	0.5

\* Flatness = variation over band divided by 2.

† 0.5 Watt at 70°C ambient, derate linearly .015W/°C above 70°C

### Typical Performance Data

Frequency (MHz)	Attenuation (dB)	VSWR (:1)
1.00	10.01	1.01
100.00	10.03	1.01
200.00	10.06	1.02
400.00	10.07	1.03
600.00	10.08	1.05
800.00	10.08	1.06
1000.00	10.09	1.07
1400.00	10.11	1.09
1600.00	10.11	1.11
2000.00	10.15	1.12

### Electrical Schematic

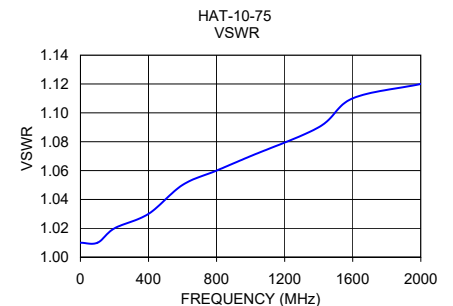
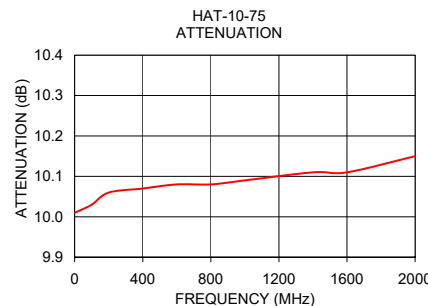
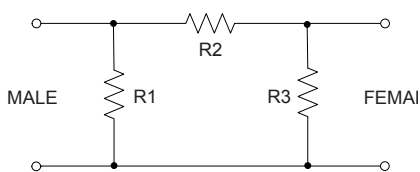

### Notes

- Performance and quality attributes and conditions not expressly stated in this specification document are intended to be excluded and do not form a part of this specification document.
- Electrical specifications and performance data contained in this specification document are based on Mini-Circuit's applicable established test performance criteria and measurement instructions.
- The parts covered by this specification document are subject to Mini-Circuits standard limited warranty and terms and conditions (collectively, "Standard Terms"); Purchasers of this part are entitled to the rights and benefits contained therein. For a full statement of the Standard Terms and the exclusive rights and remedies thereunder, please visit Mini-Circuits' website at [www.minicircuits.com/MCLStore/terms.jsp](http://www.minicircuits.com/MCLStore/terms.jsp)

# Fixed Attenuator

# HAT-10-75+

## Typical Performance Data

FREQUENCY (MHz)	ATTENUATION (dB)	RETURN LOSS (dB)
1.00	10.01	46.06
100.00	10.03	46.06
200.00	10.06	40.09
400.00	10.07	36.61
600.00	10.08	32.26
800.00	10.08	30.71
1000.00	10.09	29.42
1400.00	10.11	27.32
1600.00	10.11	25.66
2000.00	10.15	24.94

REV. X1  
HAT-10-75+  
061108  
Page 1 of 1



IF/RF MICROWAVE COMPONENTS • ISO 9001 ISO 14001 AS 9100 CERTIFIED RoHS compliant  
P.O. Box 350166, Brooklyn, New York 11235-0003 (718) 934-4500 Fax (718) 332-4661



The Design Engineers Search Engine finds the model you need, Instantly • For detailed performance specs & shopping online see



## Typical Performance Curves

Attenuation

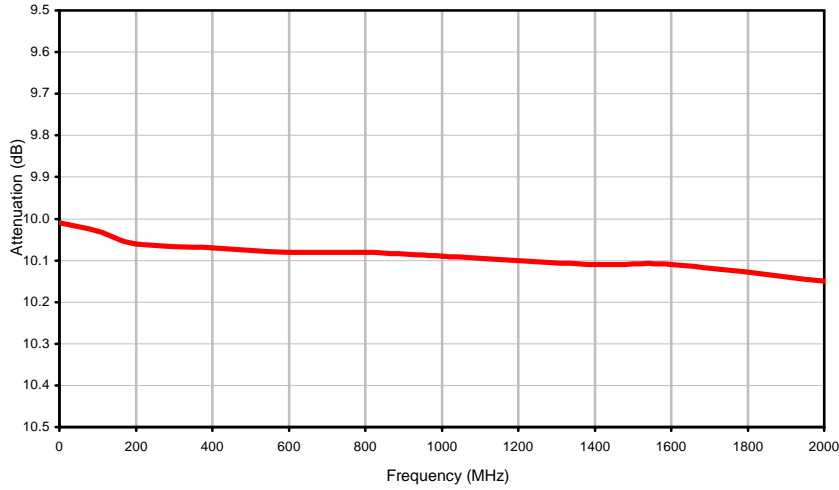

Return Loss

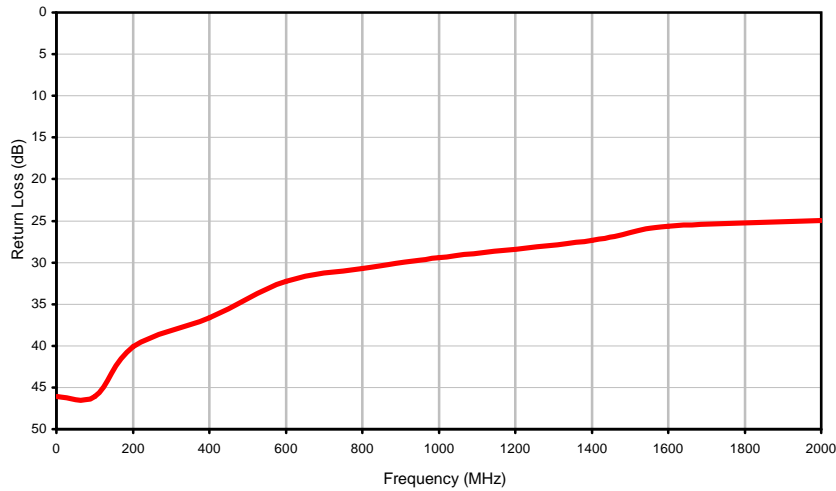

# Case Style

# FF

## Outline Dimensions

### FF747

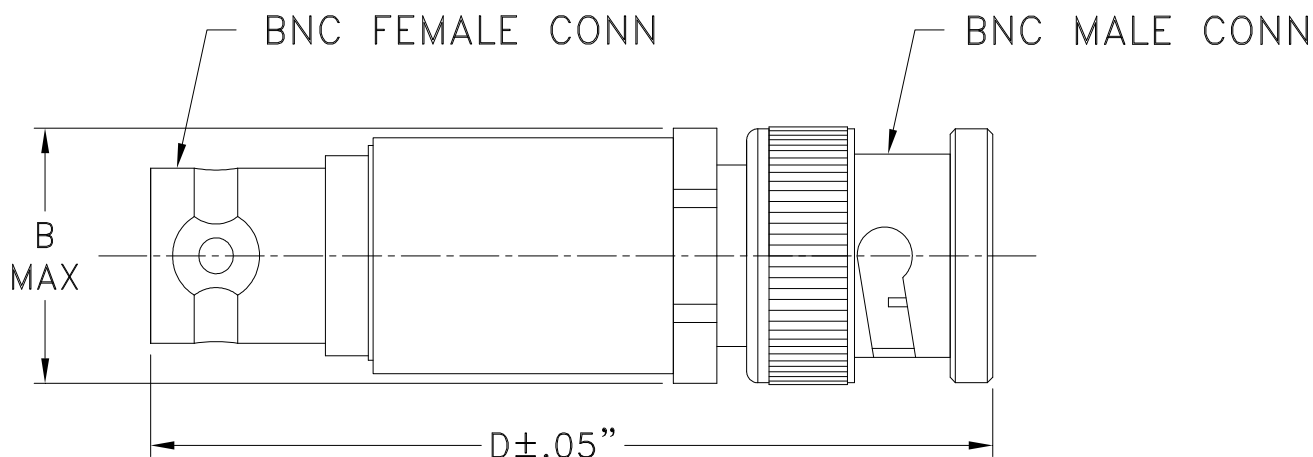

CASE #.	A	B	C	D	E	WT GRAMS
FF747	--	.62 (15.75)	--	1.94 (49.28)	--	30.0

Dimensions are in inches (mm). Tolerances: 2Pl. ± .04; 3Pl. ± .030

### Notes:

1. Case material: Brass.
2. Case finish: Nickel plate.

**Mini-Circuits®**  
ISO 9001 ISO 14001 CERTIFIED

ALL NEW  
minicircuits.com

P.O. Box 350166, Brooklyn, New York 11235-0003 (718) 934-4500 Fax (718) 332-4661 For detailed performance specs & shopping online see Mini-Circuits web site



The Design Engineers Search Engine Provides ACTUAL Data Instantly From MINI-CIRCUITS At: [www.minicircuits.com](http://www.minicircuits.com)

RF/IF MICROWAVE COMPONENTS



All Mini-Circuits products are manufactured under exacting quality assurance and control standards, and are capable of meeting published specifications after being subjected to any or all of the following physical and environmental test.

<b>Specification</b>	<b>Test/Inspection Condition</b>	<b>Reference/Spec</b>
Operating Temperature	-45° to 100° C Ambient Environment	Individual Model Data Sheet
Storage Temperature	-55° to 100° C Ambient Environment	Individual Model Data Sheet
Barometric Pressure	100,000 Feet	MIL-STD-202, Method 105, Condition D
Humidity	90% RH, 65°C Units may require bake-out after humidity to restore full performance.	MIL-STD-202, Method 103
Thermal Shock	-65° to 125°C, 5 cycles	MIL-STD-202, Method 107, Condition B
Vibration (High Frequency)	20g peak, 10-2000 Hz, 12 times in each of three perpendicular directions (total 36)	MIL-STD-202, Method 204, Condition D
Mechanical Shock	100g, 6ms sawtooth, 3 shocks each direction 3 axes (total 18)	MIL-STD-202, Method 213, Condition I