



LTCC SURFACE MOUNT

High Pass Filter

HFHKI-7300+

50Ω 7.9 to 17.5 GHz

THE BIG DEAL

- Low Insertion Loss, Typ. 1.5 dB
- Strong Stopband Rejection
- 1210 Surface Mount Footprint
- Power Handling: 6 W
- Integrated CPWGW interposer for easy SMT integration
- Protected by US Patents 11,638,370 and 11,744,057

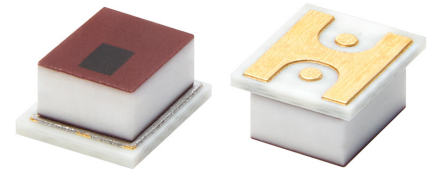

Generic photo used for illustration purposes only

APPLICATIONS

- X-band and Ku-band Radar Systems
- EW and ECM Systems
- Microwave Communications and Backhaul
- Test and Measurement Equipment

FUNCTIONAL DIAGRAM

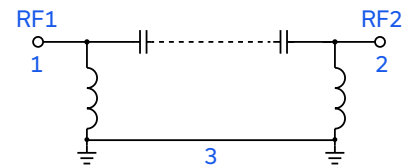

PRODUCT OVERVIEW

Mini-Circuits' HFHKI-7300+ is a miniature low temperature co-fired ceramic (LTCC) high pass filter with a 7900 to 17,500 MHz passband that supports a wide range of microwave applications. Housed in a compact 1210 package, the device incorporates an integrated interposer optimized for CPWGW surface-mount attachment, simplifying PCB integration and ensuring consistent RF performance. The LTCC fabrication process ensures stable electrical performance and high reliability under demanding environmental conditions. Its monolithic structure minimizes intrinsic non-linearities and supports wide, multi-octave passband performance.

ELECTRICAL SPECIFICATIONS^{1,2,3} AT +25 °C, Z₀ = 50 Ω

Parameter		F#	Frequency (GHz)	Min.	Typ.	Max.	Units
Passband	Insertion Loss	F4-F5	7.9-9.5	—	2.6	—	dB
		F5-F6	9.5-15.5	—	1.5	2.1	
		F6-F7	15.5-17.5	—	3.8	—	
	Return Loss	F4-F5	7.9-9.5	—	8.5	—	dB
		F5-F6	9.5-15.5	—	9	—	
		F6-F7	15.5-17.5	—	9	—	
Stopband	Rejection	DC-F1	DC-2.0	54	64	—	dB
		F1-F2	2.0-3.7	40	49	—	
		F2-F3	3.7-5.5	—	23	—	
	Freq. Cut-Off ⁴	F _c	7.3	—	3	—	dB

1. Tested in Evaluation Board P/N TB-HFHKI-7300C+.

2. This filter is bi-directional RF1 and RF2 ports may be interchanged, see S-Parameters for actual performance.

3. This component should not be used as a DC-block. In applications where DC voltage and/or current is present at either the input or output ports, external DC blocking capacitors are required.

4. Typical variation ± 5%

ABSOLUTE MAXIMUM RATINGS⁵

Operating Temperature	-55 °C to +125 °C
Storage Temperature	-55 °C to +125 °C
Input Power ⁶	6 W

5. Permanent damage may occur if any of these limits are exceeded.

6. Power rating applies only to signals within the passband. Power rating above +25 °C operating temperature decreases linearly to 1 W at +125°C.

TYPICAL FREQUENCY RESPONSE

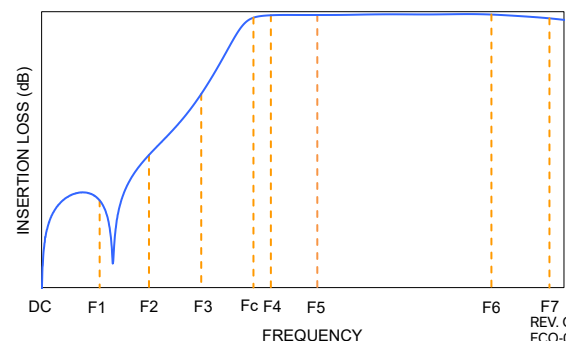



LTCC SURFACE MOUNT

High Pass Filter

HFHKI-7300+

Mini-Circuits

50Ω 7.9 to 17.5 GHz

TYPICAL PERFORMANCE GRAPHS

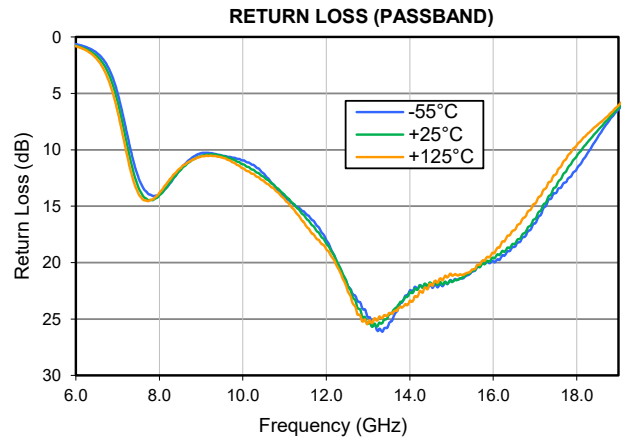
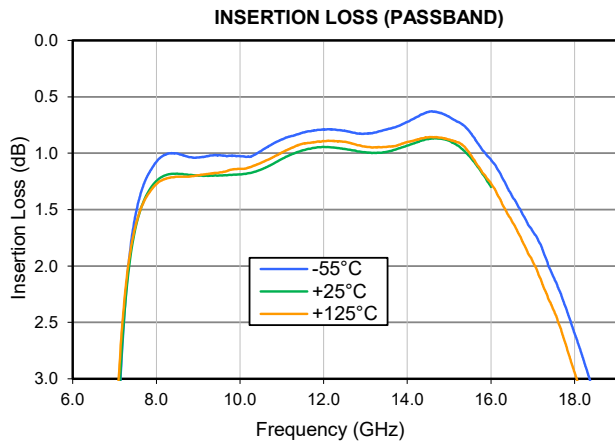
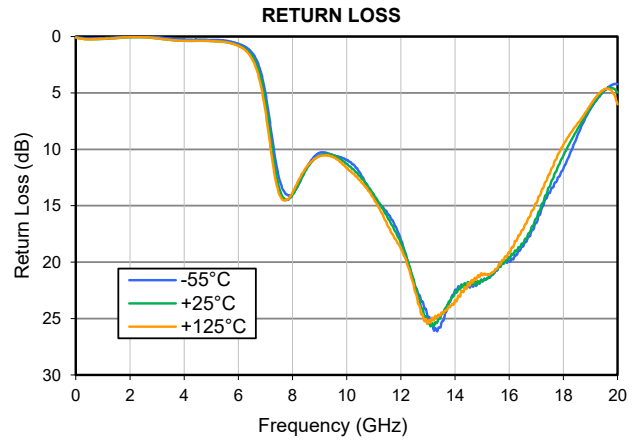
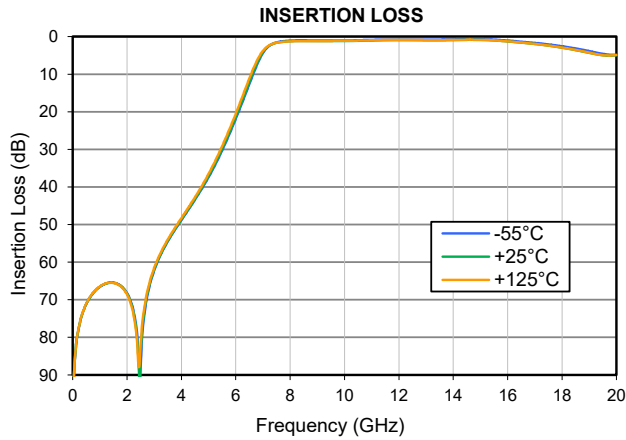



FUNCTIONAL DIAGRAM



Figure 1. HFHKI-7300+ Functional Diagram

PAD DESCRIPTION

Function	Pad Number	Description
RF1 ²	1	Connects to RF Input Port
RF2 ²	2	Connects to RF Output Port
GROUND	3	Connects to Ground on PCB, (See drawing PL-837)

SUGGESTED PCB LAYOUT (PL-837)

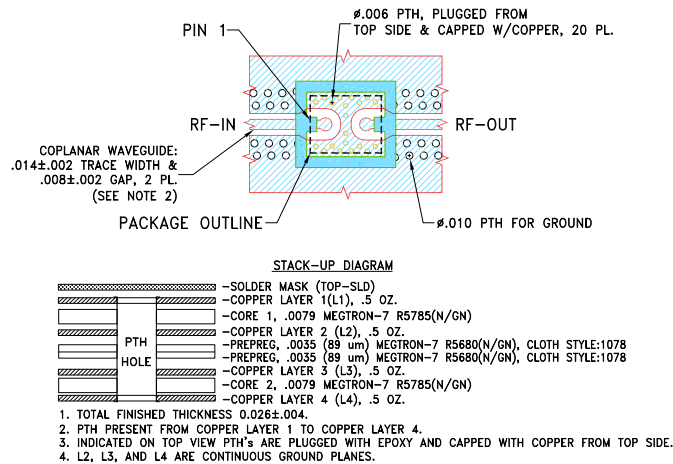
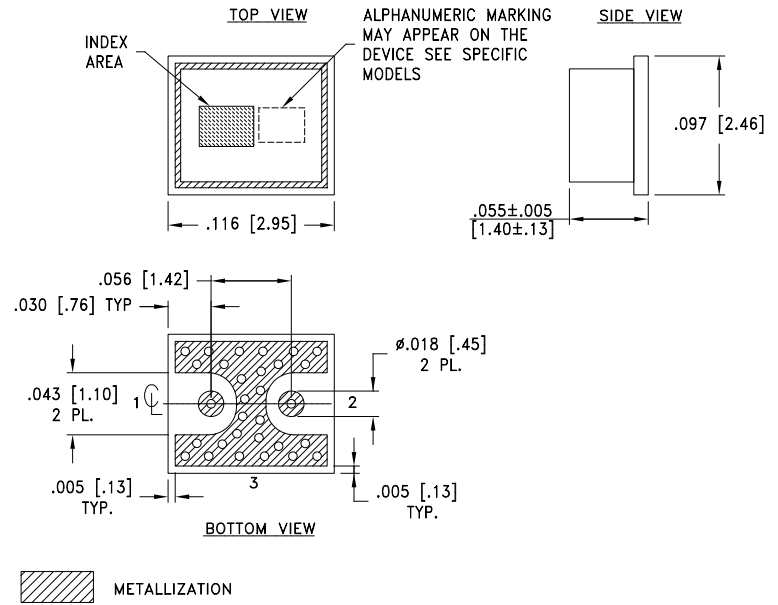

Figure 2. Suggested PCB Layout

CASE STYLE DRAWING



Weight: .021 grams
Dimensions are in inches [mm]. Tolerances: 2 Pl. ±.01; 3 Pl. ±.005 Inches

PRODUCT MARKING*: U3

*Marking may contain other features or characters for internal lot control.



LTCC SURFACE MOUNT

High Pass Filter

HFHKI-7300+

50Ω 7.9 to 17.5 GHz

Mini-Circuits

ADDITIONAL DETAILED INFORMATION IS AVAILABLE ON OUR DASHBOARD

[CLICK HERE](#)

Performance Data & Graphs	Data Graphs S-Parameter (S2P Files) Data Set (.zip file) De-embedded to device pads
Case Style	NM3723-1 Lead Finish: Gold Plate over Nickel Plate
RoHS/REACH Status	Compliant
Tape and Reel	F66-3
Suggested Layout for PCB Design	PL-837
Evaluation Board	TB-HFHKI-7300C+ Gerber File
Environmental Rating	ENV06T10

NOTES

- A. Performance and quality attributes and conditions not expressly stated in this specification document are intended to be excluded and do not form a part of this specification document.
- B. Electrical specifications and performance data contained in this specification document are based on Mini-Circuits' applicable established test performance criteria and measurement instructions.
- C. The parts covered by this specification document are subject to Mini-Circuits' standard limited warranty and terms and conditions (collectively, "Standard Terms"); Purchasers of this part are entitled to the rights and benefits contained therein. For a full statement of the standard terms and the exclusive rights and remedies thereunder, please visit Mini-Circuits' website at www.minicircuits.com/terms/viewterm.html



LTCC High Pass Filter

Typical Performance Data

HFHKL-7300+

FREQUENCY (GHz)	INSERTION LOSS (dB)			RETURN LOSS (dB)		
	@-55°C	@+25°C	@+125°C	@-55°C	@+25°C	@+125°C
4.00	48.82	48.62	48.28	0.26	0.38	0.38
4.20	46.65	46.49	46.11	0.28	0.39	0.39
4.40	44.47	44.29	43.84	0.29	0.38	0.38
4.60	42.21	42.00	41.53	0.28	0.38	0.37
4.80	39.88	39.61	39.10	0.28	0.38	0.38
5.00	37.39	37.06	36.48	0.29	0.40	0.40
5.20	34.73	34.31	33.69	0.30	0.42	0.42
5.40	31.82	31.36	30.66	0.32	0.45	0.45
5.60	28.70	28.22	27.44	0.40	0.52	0.53
5.80	25.37	24.89	24.06	0.50	0.62	0.65
6.00	21.88	21.38	20.49	0.64	0.78	0.82
6.20	18.25	17.70	16.75	0.84	1.01	1.10
6.40	14.52	13.93	12.96	1.16	1.40	1.58
6.60	10.76	10.19	9.30	1.74	2.08	2.44
6.80	7.21	6.77	6.09	2.88	3.39	4.00
7.00	4.37	4.15	3.77	4.99	5.74	6.61
7.20	2.63	2.61	2.46	8.14	9.07	10.04
7.40	1.78	1.87	1.82	11.31	12.25	13.01
7.60	1.39	1.53	1.52	13.29	14.04	14.39
7.80	1.19	1.35	1.37	14.01	14.45	14.44
8.00	1.08	1.25	1.27	13.96	14.05	13.82
8.20	1.02	1.20	1.23	13.25	13.20	12.88
8.40	1.00	1.18	1.21	12.27	12.26	12.01
8.60	1.01	1.18	1.21	11.31	11.46	11.33
8.80	1.04	1.19	1.21	10.65	10.88	10.87
9.00	1.04	1.20	1.20	10.31	10.54	10.60
9.20	1.03	1.20	1.18	10.29	10.42	10.54
9.40	1.02	1.20	1.17	10.44	10.47	10.62
9.60	1.02	1.20	1.17	10.59	10.64	10.82
9.80	1.02	1.19	1.15	10.71	10.90	11.16
10.00	1.03	1.19	1.14	10.94	11.29	11.65
10.20	1.03	1.18	1.13	11.29	11.72	12.09
10.40	1.00	1.16	1.10	11.74	12.14	12.51
10.60	0.96	1.13	1.07	12.51	12.67	13.03
10.80	0.91	1.09	1.03	13.44	13.34	13.68
11.00	0.88	1.05	0.99	14.16	13.99	14.38
11.20	0.85	1.02	0.96	14.78	14.76	15.21
11.40	0.83	0.99	0.93	15.36	15.59	16.19
11.60	0.81	0.96	0.91	15.96	16.40	17.11
11.80	0.80	0.95	0.90	16.81	17.29	17.96
12.00	0.79	0.94	0.89	18.01	18.32	18.83
12.20	0.79	0.95	0.89	19.45	19.47	19.88
12.40	0.80	0.96	0.90	21.14	21.05	21.48
12.60	0.81	0.97	0.91	22.49	22.64	23.19
12.80	0.83	0.98	0.93	23.48	24.11	24.62
13.00	0.83	0.99	0.94	24.86	25.43	25.40
13.20	0.82	1.00	0.95	25.88	25.66	25.15
13.40	0.80	0.99	0.95	25.80	25.06	24.66
13.60	0.78	0.98	0.94	24.91	24.27	24.40
13.80	0.76	0.96	0.93	23.56	23.49	23.97
14.00	0.72	0.93	0.90	22.48	22.64	23.39
14.20	0.68	0.91	0.88	22.26	22.34	22.92
14.40	0.65	0.88	0.87	22.10	22.01	22.30
14.60	0.63	0.87	0.86	21.96	21.73	21.63
14.80	0.64	0.87	0.86	22.04	21.89	21.49
15.00	0.68	0.89	0.88	21.64	21.70	21.11
15.20	0.72	0.93	0.90	21.38	21.40	21.05
15.40	0.77	1.00	0.96	21.11	20.98	20.91
15.60	0.86	1.08	1.06	20.47	20.42	20.28
15.80	0.97	1.19	1.17	20.11	20.13	19.81
16.00	1.06	1.30	1.27	19.88	19.57	19.12
16.20	1.16	1.42	1.39	19.44	19.05	18.25
16.40	1.31	1.55	1.54	18.96	18.68	17.55
16.60	1.43	1.68	1.67	18.20	17.92	16.62
16.80	1.57	1.83	1.82	17.43	17.12	15.70
17.00	1.69	1.97	1.96	16.53	16.13	14.78
17.20	1.82	2.13	2.13	15.19	14.87	13.58
17.40	2.02	2.32	2.31	14.23	13.83	12.67
17.60	2.19	2.52	2.49	13.40	12.66	11.57
17.80	2.38	2.73	2.71	12.51	11.52	10.44
18.00	2.60	2.96	2.94	11.70	10.56	9.60
18.20	2.82	3.21	3.18	10.67	9.60	8.82
18.40	3.05	3.47	3.43	9.48	8.72	8.10
18.60	3.30	3.75	3.71	8.35	7.91	7.50
18.80	3.57	4.04	3.98	7.29	7.08	6.78
19.00	3.88	4.35	4.29	6.43	6.32	6.07

Typical Performance Data

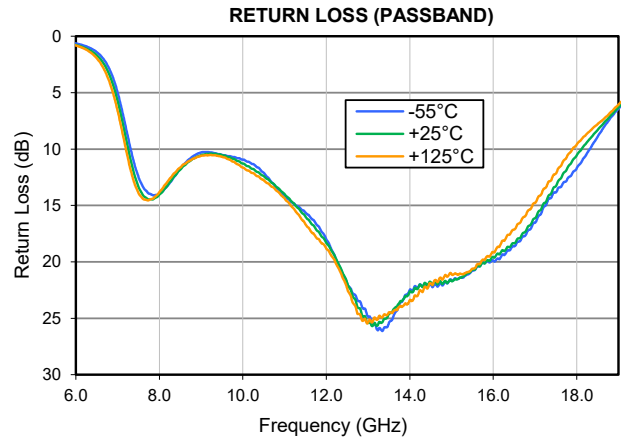
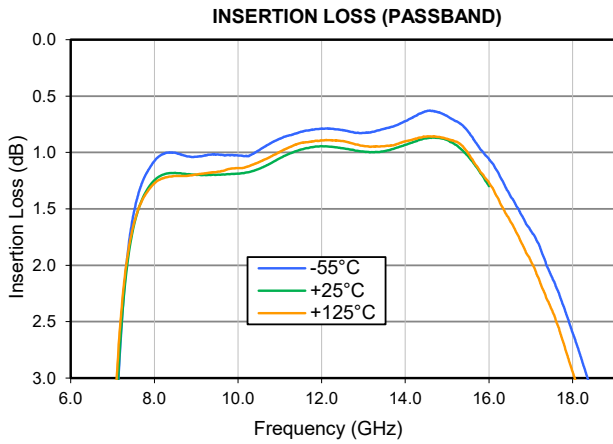
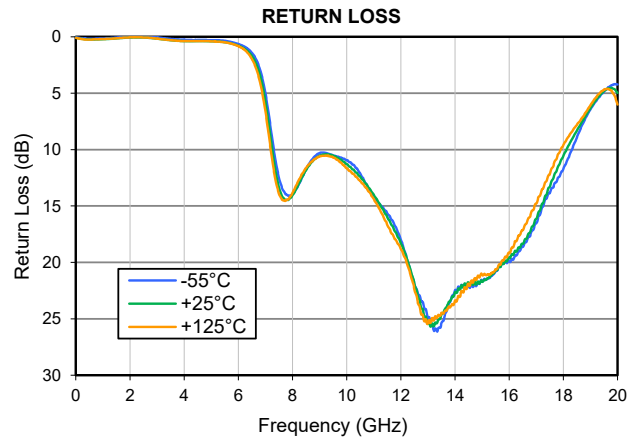
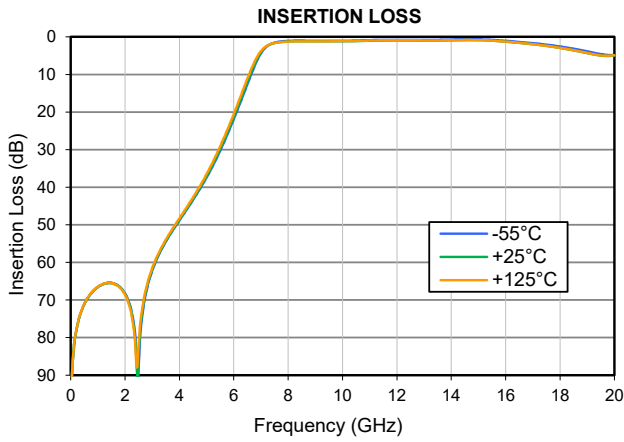

Case Style

NM

Outline Dimensions

NM3723-1

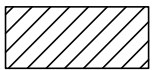
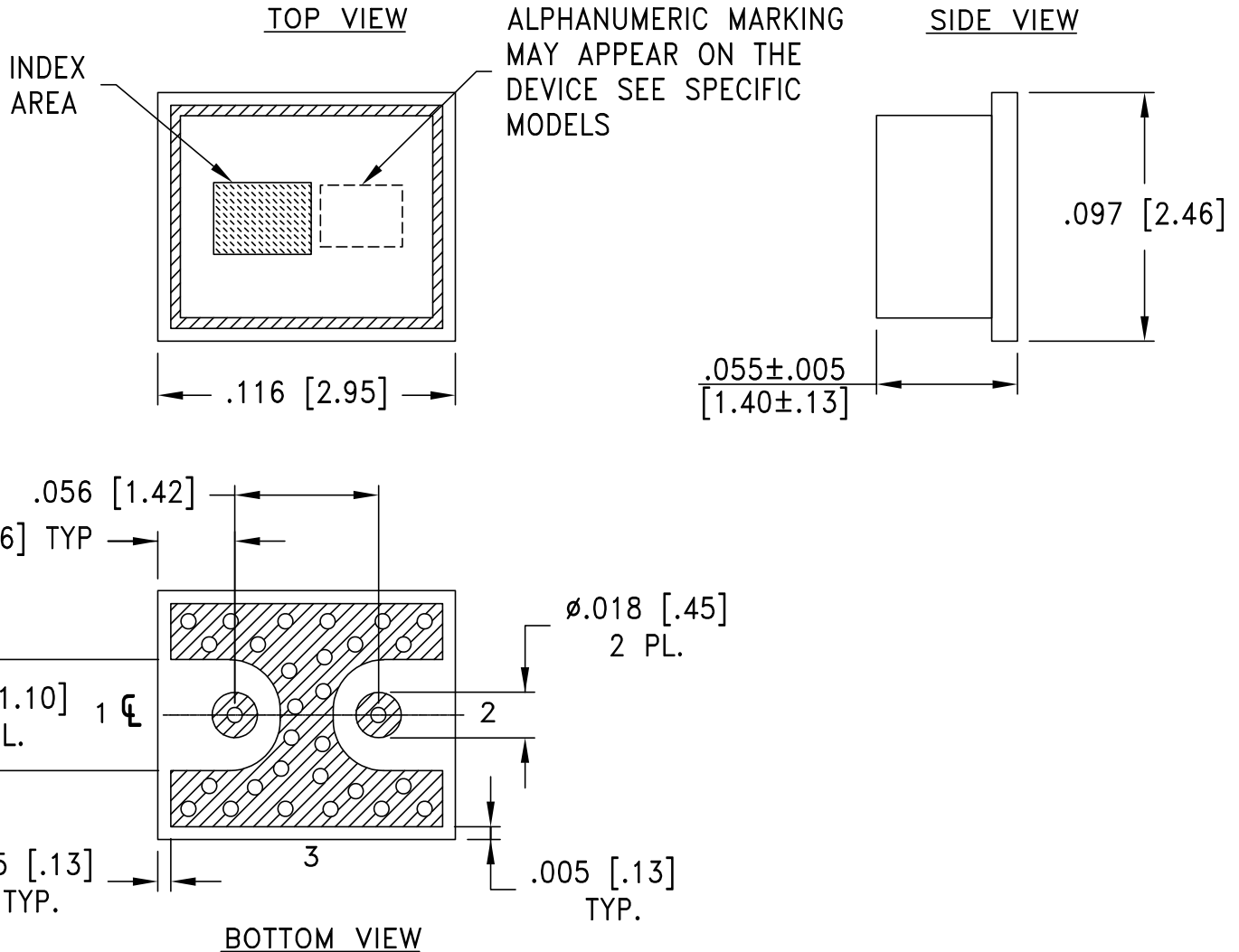

METALLIZATION

Weight: .021 grams

Dimensions are in inches [mm]. Tolerances: 2 Pl. ±.01; 3 Pl. ±.005 inches

Notes:

1. Case material: LTCC on printed circuit board base.
2. Termination Finish: **as shown below or indicated on Data Sheet.**
For RoHS Case Styles: Gold Plate over Nickel plate. All models, (+) suffix.

Mini-Circuits[®]

INTERNET <http://www.minicircuits.com>

P.O. Box 350166, Brooklyn, New York 11235-0003 (718) 934-4500 Fax (718) 332-4661

Distribution Centers NORTH AMERICA 800-654-7949 • 417-335-5935 • Fax 417-335-5945 • EUROPE 44-1252-832600 • Fax 44-1252-837010

Mini-Circuits ISO 9001 & ISO 14001 Certified

Tape & Reel Packaging TR-F66-3

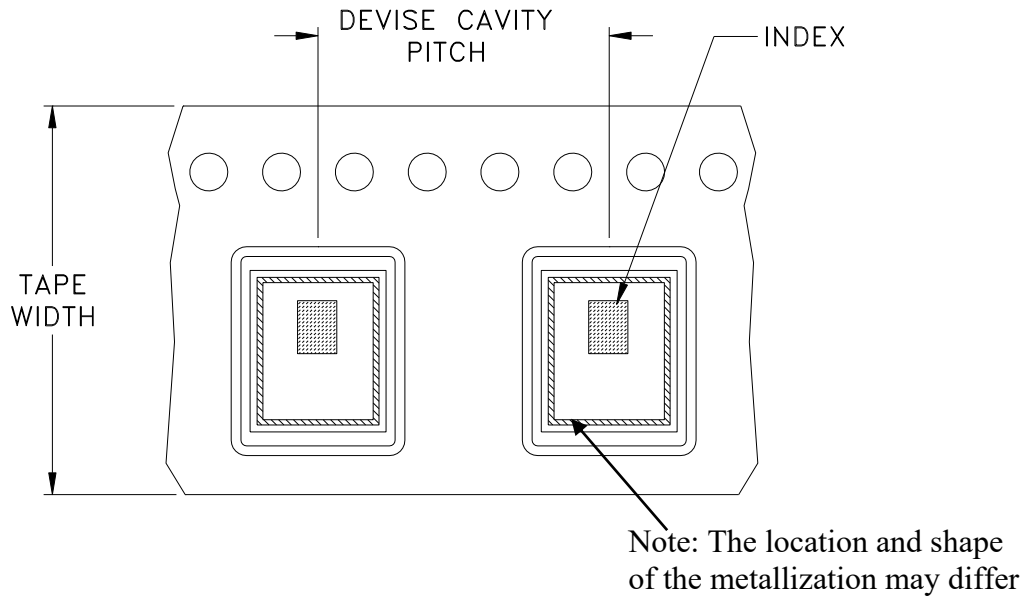

Tape Width, mm	Device Cavity Pitch, mm	Reel Size, inches	Devices per Reel see note	
8	4	7	Small quantity standard	20
				50
				100
				200
				500
		7	Standard	1000

Note: Please consult individual model data sheet to determine device per reel availability.

Mini-Circuits carrier tape materials provide protection from ESD (Electro-Static Discharge) during handling and transportation. Tapes are static dissipative and comply with industry standards EIA-481/EIA-541.

Go to: www.minicircuits.com/pages/pdfs/tape.pdf



INTERNET <http://www.minicircuits.com>

P.O. Box 350166, Brooklyn, New York 11235-0003 (718) 934-4500 Fax (718) 332-4661

Distribution Centers NORTH AMERICA 800-654-7949 • 417-335-5935 • Fax 417-335-5945 • EUROPE 44-1252-832600 • Fax 44-1252-837010

Mini-Circuits ISO 9001 & ISO 14001 Certified

THIRD ANGLE PROJECTION

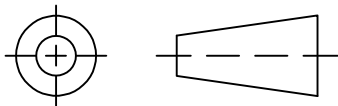

REVISIONS

REV	ECN No.	DESCRIPTION	DATE	DR	AUTH
OR	ECO-026948	NEW RELEASE	09/15/25	ITG	IL

SUGGESTED MOUNTING CONFIGURATION
FOR NM3723-1 CASE STYLE

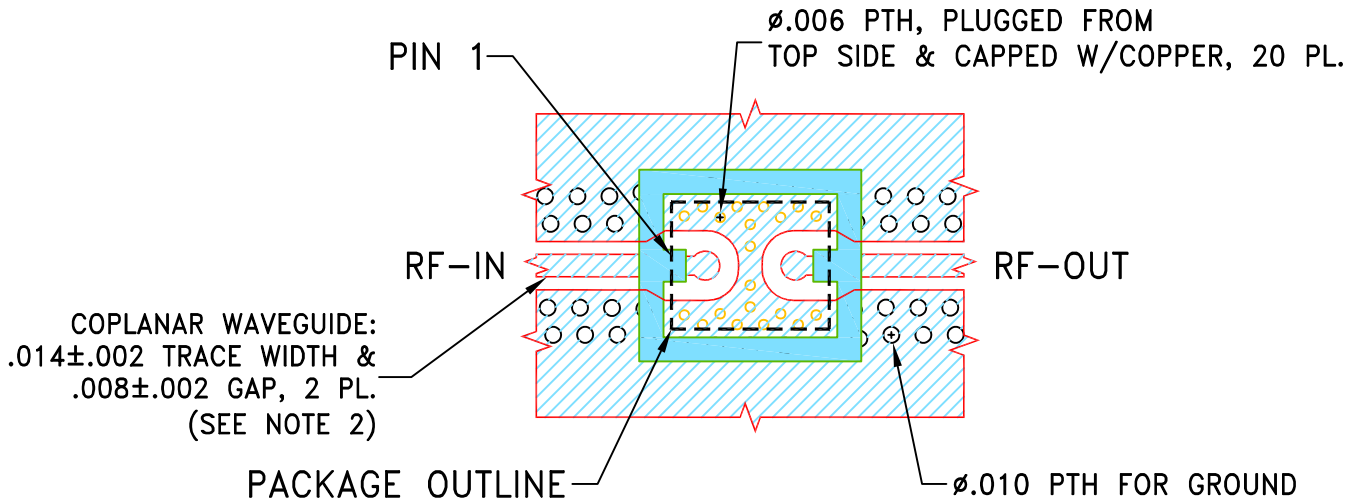

STACK-UP DIAGRAM

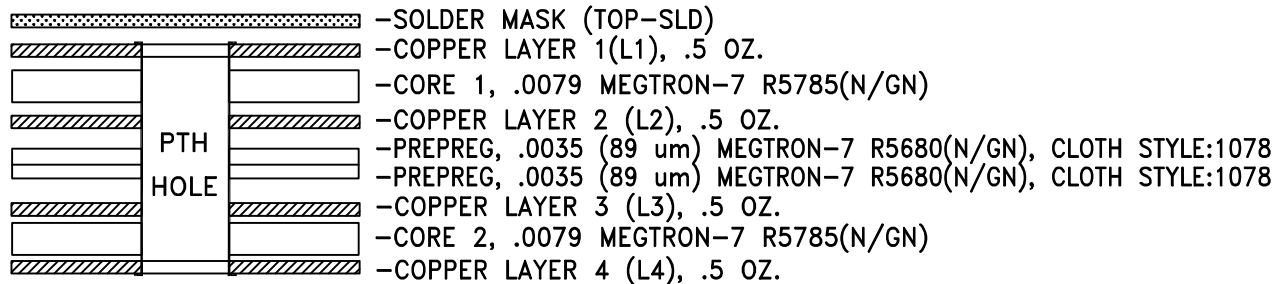

1. TOTAL FINISHED THICKNESS 0.026±.004.
2. PTH PRESENT FROM COPPER LAYER 1 TO COPPER LAYER 4.
3. INDICATED ON TOP VIEW PTH'S ARE PLUGGED WITH EPOXY AND CAPPED WITH COPPER FROM TOP SIDE.
4. L2, L3, AND L4 ARE CONTINUOUS GROUND PLANES.

NOTES:

1. PCB IS MULTILAYER PCB, SEE STACK-UP DIAGRAM.
2. TRACE WIDTH & GAP ARE SHOWN FOR MEGTRON-7 R5785(N/GN) WITH DIELECTRIC THICKNESS .0079", COPPER: 1 OZ. EACH LAYER. FOR OTHER MATERIALS TRACE WIDTH & GAP MAY NEED TO BE MODIFIED.
3. LAYERS L2, L3 & L4 OF PCB ARE CONTINUOUS GROUND PLANES.



DENOTES PCB COPPER LAYOUT WITH SMOBC (SOLDER MASK OVER BARE COPPER).



DENOTES COPPER LAND PATTERN FREE OF SOLDER MASK.

UNLESS OTHERWISE SPECIFIED	INITIALS	DATE
DIMENSIONS ARE IN INCHES	DRAWN ITG	09/15/25
TOLERANCES ON:	CHECKED GF	09/15/25
2 PL DECIMALS ±	APPROVED IL	09/15/25
3 PL DECIMALS ± .005		
ANGLES ±		
FRACTIONS ±		



Mini-Circuits[®]

13 Neptune Avenue
Brooklyn NY 11235

PL, NM3723-1, TB-HFHKI-2200C+

SIZE A	CODE IDENT 15542	DRAWING NO: 98-PL-837	REV: OR
FILE: 98PL837	SCALE: 8:1	SHEET: 1 OF 1	

Mini-Circuits[®]

THIS DOCUMENT AND ITS CONTENTS ARE THE PROPERTY OF MINI-CIRCUITS. EXCEPT FOR USE EXPRESSLY GRANTED, IN WRITING, TO ITS VENDORS, VENDEE AND THE UNITED STATES GOVERNMENT, MINI-CIRCUITS RESERVES ALL PROPRIETARY DESIGN, USE, MANUFACTURING AND REPRODUCTION RIGHTS THERETO. THESE CONTENTS SHALL NOT BE USED, DUPLICATED OR DISCLOSED TO ANY OUTSIDE PARTY, IN WHOLE OR IN PART, WITHOUT WRITTEN PERMISSION OF MINI-CIRCUITS.

Evaluation Board and Circuit

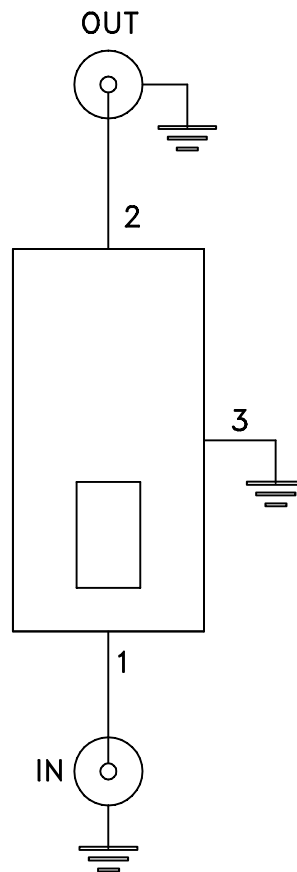
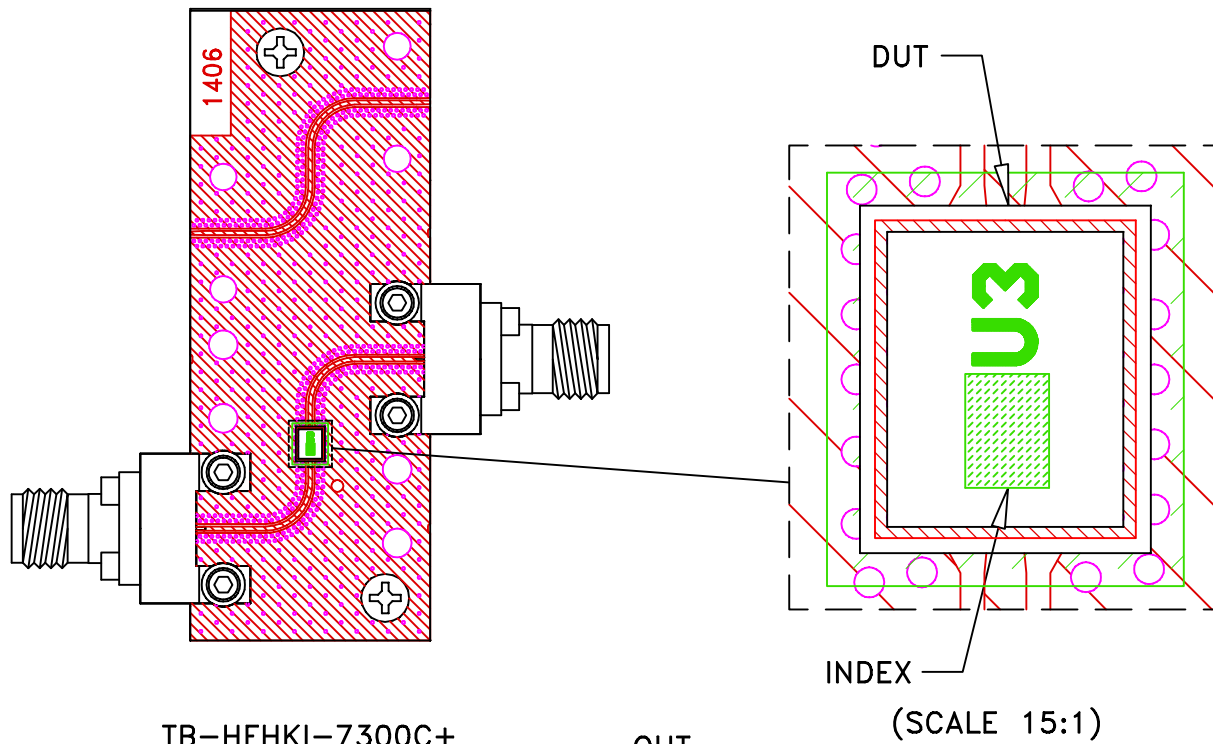

Schematic Diagram

1. 50 Ohm 2.4 mm Female end Launch connectors.
2. PCB Material: MEGTRON-7 R5785 (N or GN) or equivalent,
Dielectric Constant= 3.37 Thickness=.0079 inch.

 **Mini-Circuits®**

All Mini-Circuits products are manufactured under exacting quality assurance and control standards, and are capable of meeting published specifications after being subjected to any or all of the following physical and environmental test.

Specification	Test/Inspection Condition	Reference/Spec
Operating Temperature	-55° to 125° C Ambient Environment	Individual Model Data Sheet
Storage Temperature	-55° to 125° C Ambient Environment	Individual Model Data Sheet
Humidity	90 to 95% RH, 240 hours, 50°C	MIL-STD-202, Method 103, Condition A, Except 50°C and end-point electrical test done within 12 hours
Solder Reflow Heat	Sn-Pb Eutectic Process 225°C peak Pb-Free Process 245° - 250°C peak	J-STD-020C, Table 4-1, 4-2 and 5-2, Figure 5-1
Solderability	10X Magnification	J-STD-002, Test B,B1, 95% Coverage
Thermal Shock	-55° to +125°C, 15 min dwell,250 cycles	MIL-STD-202, Method 107
Bend Test	1mm, deflection for 5 seconds Span of bending: 2.75"	--
High Temp Storage	125°C to 1000 Hrs	---