

Engineering Development Model

Power Splitter/Combiner

2 Way-90°

JYPQ-ED6655/2

Important Note

This model has been designed, built and tested in our engineering department. Performance data represents model capability. At present it is a non-catalog model. On request, we can supply a final specification sheet, part number and price/delivery information.



Please click "Back", and then click "Contact Us" for Applications support.

CASE STYLE : BJ293

ELECTRICAL SPECIFICATIONS 50Ω @ +25°C					
Parameter		Min.	Typ.	Max.	Units
Frequency		10		37	MHz
Isolation	10 - 37 MHz		28		dB
Insertion Loss					
Average of Coupled Outputs above 3.0 dB	10 - 37 MHz		0.34		dB
Phase Unbalance	10 - 37 MHz		0.062		deg.
Amplitude Unbalance	10 - 37 MHz		1.247		dB
VSWR	SUM Port		1.19		(:1)
	OUT Ports		1.12		(:1)

MAXIMUM RATINGS	
Operating Temperature	-40°C to 85°C
Storage Temperature	-55°C to 100°C

PIN CONNECTIONS	
SUM PORT	8
PORT 1	1
PORT 2	4
GND EXT	2, 3, 6, 7
50Ω TERMINATION	5

Functional Diagram

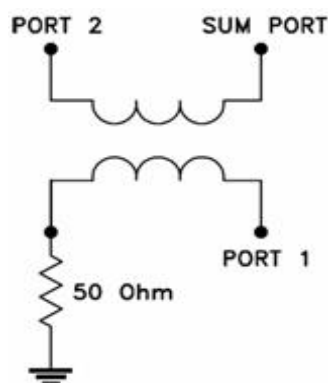

2 Way-90° Power Splitter/Combiner

JYPQ-ED6655/2

Typical Performance Data

FREQ. (MHz)	TOTAL LOSS ¹ (dB)			AMP. UNBAL. (dB)	ISOLATION (dB) 1-2	PHASE UNBAL. (deg.)	FREQ. (MHz)	VSWR (:1)		
	S-1	S-2	AVG.					S	1	2
10.0	5.77	1.49	3.63	4.28	30.83	89.36	10.0	1.14	1.04	1.14
10.8	5.37	1.65	3.51	3.71	30.50	89.28	10.8	1.14	1.04	1.15
11.5	5.02	1.82	3.42	3.20	30.22	89.25	11.5	1.15	1.05	1.15
12.3	4.71	1.98	3.35	2.73	29.97	89.27	12.3	1.15	1.05	1.15
13.1	4.45	2.15	3.30	2.30	29.76	89.28	13.1	1.16	1.05	1.15
13.8	4.21	2.30	3.26	1.91	29.56	89.24	13.8	1.16	1.05	1.16
14.6	4.00	2.45	3.23	1.55	29.38	89.29	14.6	1.16	1.05	1.16
15.4	3.81	2.60	3.21	1.21	29.22	89.31	15.4	1.16	1.05	1.16
16.1	3.65	2.75	3.20	0.91	29.07	89.28	16.1	1.17	1.05	1.16
17.1	3.47	2.92	3.20	0.56	28.88	89.30	17.1	1.17	1.05	1.16
17.6	3.41	2.99	3.20	0.42	28.80	89.30	17.6	1.17	1.05	1.16
18.0	3.34	3.05	3.20	0.29	28.72	89.34	18.0	1.17	1.05	1.16
19.0	3.21	3.20	3.21	0.01	28.55	89.34	19.0	1.17	1.05	1.17
20.0	3.10	3.32	3.21	0.23	28.40	89.39	20.0	1.18	1.05	1.17
22.0	2.94	3.52	3.23	0.58	28.08	89.47	22.0	1.18	1.05	1.18
23.0	2.89	3.61	3.25	0.72	27.91	89.82	23.0	1.19	1.05	1.18
24.0	2.87	3.66	3.27	0.80	27.77	89.59	24.0	1.19	1.05	1.18
24.6	2.86	3.70	3.28	0.83	27.66	89.71	24.6	1.20	1.05	1.19
25.3	2.86	3.72	3.29	0.86	27.57	89.77	25.3	1.20	1.06	1.19
25.9	2.86	3.73	3.30	0.87	27.47	89.83	25.9	1.20	1.06	1.19
27.5	2.91	3.73	3.32	0.82	27.23	90.07	27.5	1.21	1.06	1.20
29.0	3.01	3.69	3.35	0.68	27.01	90.41	29.0	1.22	1.06	1.21
30.6	3.17	3.59	3.38	0.42	26.79	90.87	30.6	1.24	1.07	1.23
32.2	3.40	3.45	3.43	0.05	26.60	91.43	32.2	1.25	1.08	1.24
33.7	3.73	3.26	3.50	0.47	26.43	92.20	33.7	1.27	1.09	1.26
35.3	4.20	3.03	3.62	1.17	26.32	93.37	35.3	1.29	1.10	1.28
36.9	4.85	2.76	3.81	2.08	26.24	94.90	36.9	1.30	1.11	1.29

¹Total Loss = Insertion Loss + 3dB Splitter Loss



2 Way-90° Power Splitter/Combiner

JYPQ-ED6655/2

Typical Performance Curves

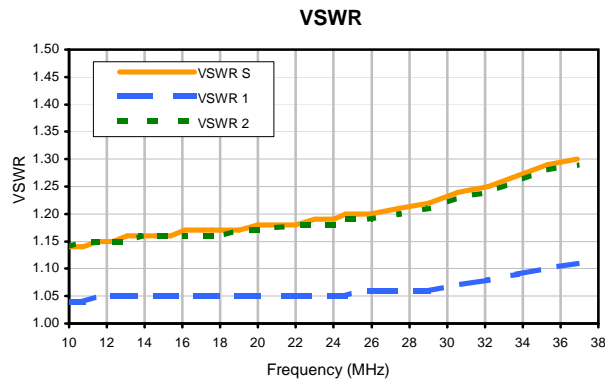
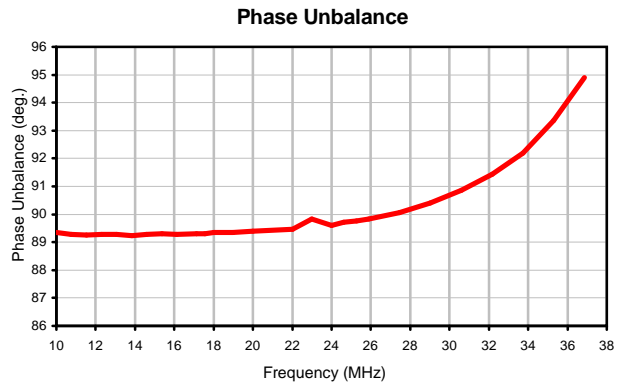
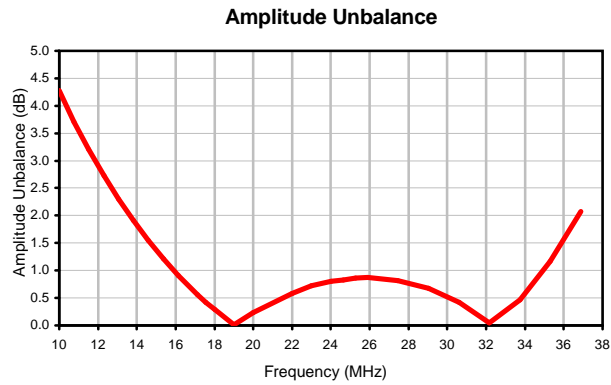
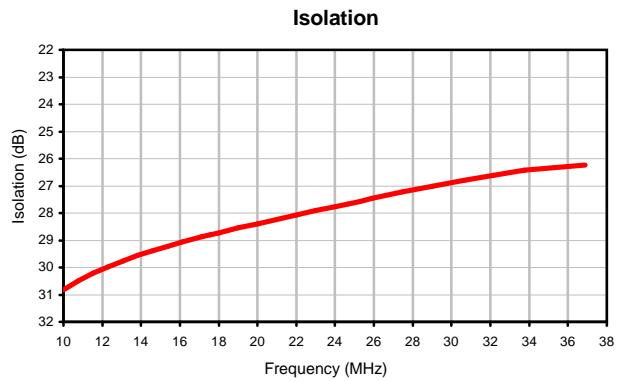
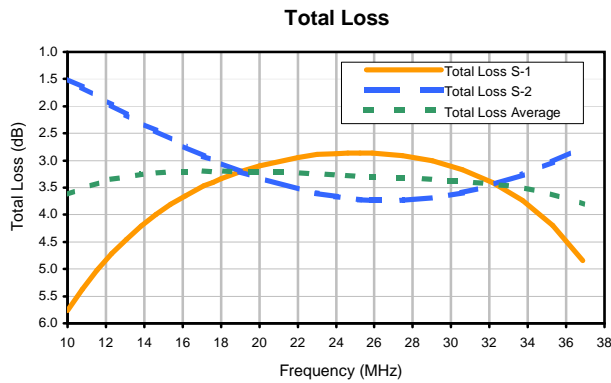

REV. X2
JYPQ-ED6655/2
100707
Page 1 of 1



RF/MICROWAVE COMPONENTS • ISO 9001 ISO 14001 AS 9100 CERTIFIED • RoHS compliant
P.O. Box 350166, Brooklyn, New York 11235-0003 (718) 934-4500 Fax (718) 332-4661



The Design Engineers Search Engine finds the model you need, instantly • For detailed performance specs & shopping online see



Case Style

BJ

Outline Dimensions

BJ293
BJ398

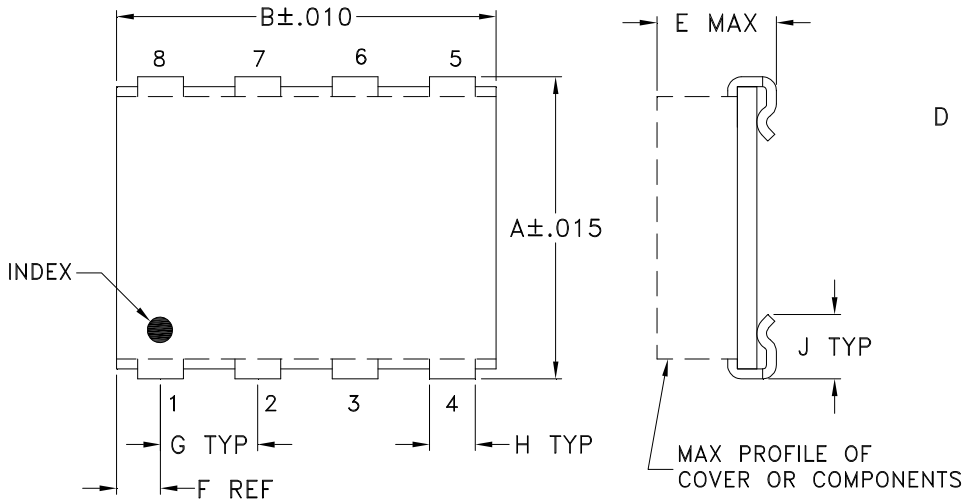

PCB Land Pattern

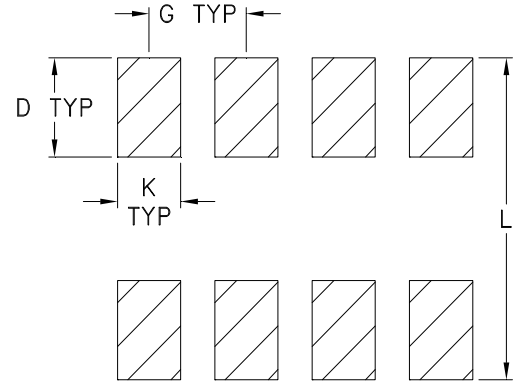

Suggested Layout,
Tolerance to be within $\pm .002$

CASE#	A	B	C	D	E	F	G	H	J	K	L	WT. GRAMS
BJ293	.395 (10.03)	.500 (12.70)	--	.100 (2.54)	.230 (5.84)	.100 (2.54)	.100 (2.54)	.047 (1.19)	.065 (1.65)	.065 (1.65)	.425 (10.80)	.80
BJ398	.305 (7.75)	.390 (9.91)	--	.100 (2.54)	.105 (2.67)	.045 (1.14)	.100 (2.54)	.047 (1.19)	.065 (1.65)	.065 (1.65)	.325 (8.26)	.20

Dimensions are in inches (mm). Tolerances: 2Pl. $\pm .01$; 3Pl. $\pm .005$

Notes:

- Case material: Plastic.
- Base material: Printed wiring laminate.
- Termination finish:
 - For RoHS Case Styles: Tin plate over Nickel plate. All models, (+) suffix.
 - For RoHS-5 Case Styles: Tin-Lead plate. All models, no (+) suffix.

Mini-Circuits®

INTERNET <http://www.minicircuits.com>

P.O. Box 350166, Brooklyn, New York 11235-0003 (718) 934-4500 Fax (718) 332-4661

Distribution Centers NORTH AMERICA 800-654-7949 • 417-335-5935 • Fax 417-335-5945 • EUROPE 44-1252-832600 • Fax 44-1252-837010

Mini-Circuits ISO 9001 & ISO 14001 Certified

Tape & Reel Packaging TR-F10

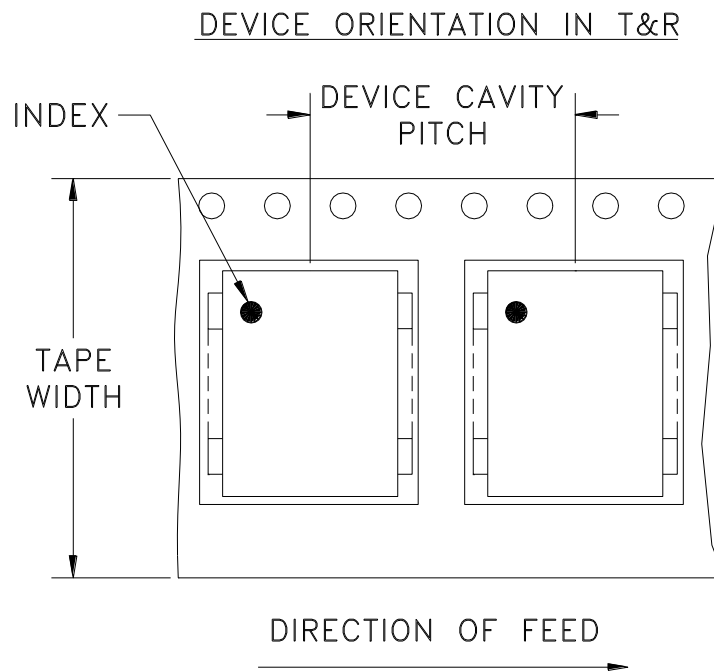

Tape Width, mm	Device Cavity Pitch, mm	Reel Size, inches	Devices per Reel
24	16	7	10,20,50,100
		13	200,500

Mini-Circuits carrier tape materials provide protection from ESD (Electro-Static Discharge) during handling and transportation. Tapes are static dissipative and comply with industry standards EIA-481/EIA-541.

Go to: www.minicircuits.com/pages/pdfs/tape.pdf

Note: Please consult individual model data sheet to determine device per reel availability.



INTERNET <http://www.minicircuits.com>

P.O. Box 350166, Brooklyn, New York 11235-0003 (718) 934-4500 Fax (718) 332-4661

Distribution Centers NORTH AMERICA 800-654-7949 • 417-335-5935 • Fax 417-335-5945 • EUROPE 44-1252-832600 • Fax 44-1252-837010

Mini-Circuits ISO 9001 & ISO 14001 Certified

THIRD ANGLE PROJECTION

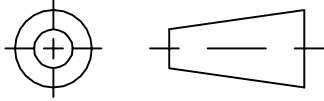

REVISIONS

REV	ECN No.	DESCRIPTION	DATE	DR	AUTH
OR	M82549	NEW RELEASE	11/15/02	MMG	HY
A	M102713	MODIFIED NOTES, ADDED "...WITH SMOBC"	01/16/06	GT	IL

**SUGGESTED MOUNTING CONFIGURATION
FOR BJ293 CASE STYLE, "kx" PIN CONNECTION.**

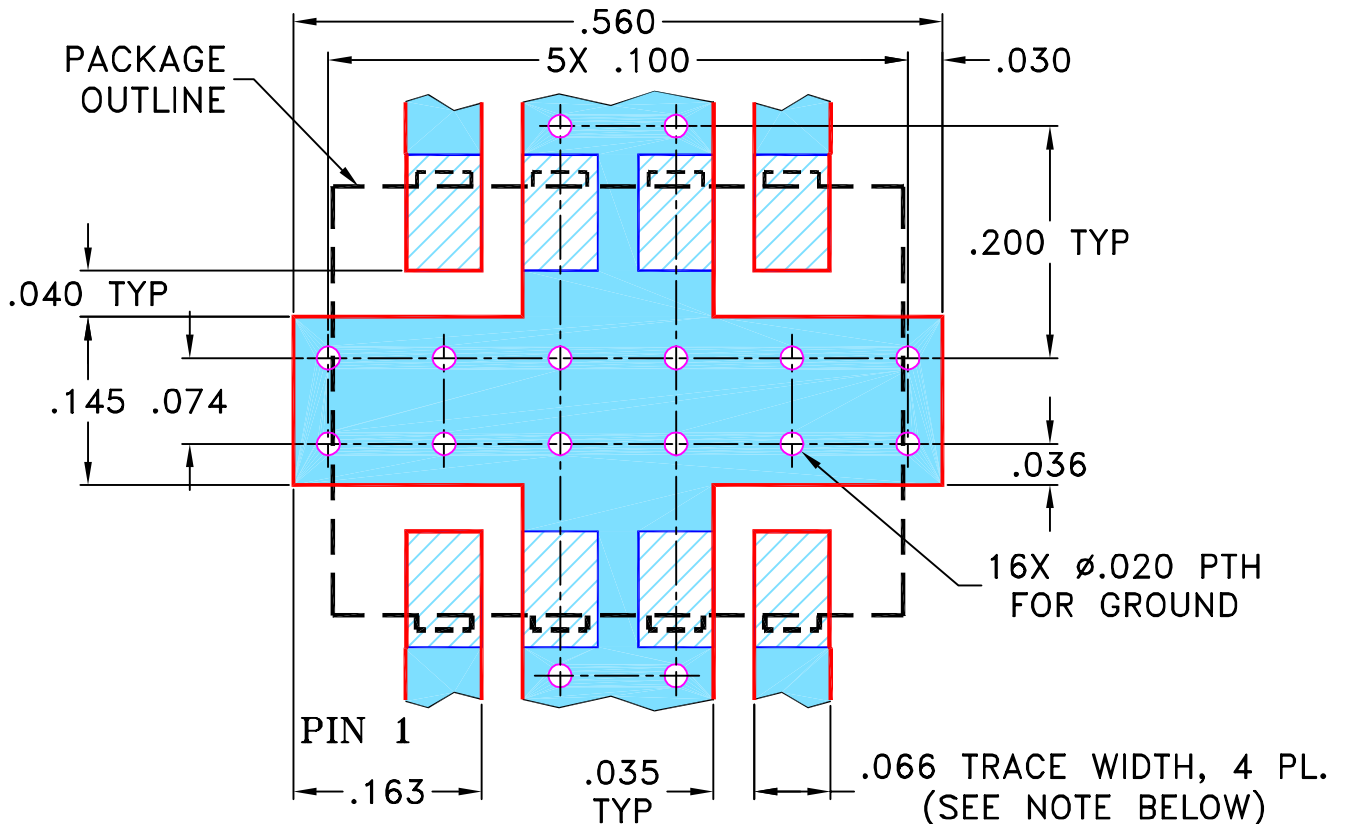

- NOTES:**
- TRACE WIDTH IS SHOWN FOR ROGERS R04350B WITH DIELECTRIC THICKNESS .030" ± .002". COPPER: 1/2 OZ. EACH SIDE. FOR OTHER MATERIALS TRACE WIDTH MAY NEED TO BE MODIFIED.
 - BOTTOM SIDE OF THE PCB IS CONTINUOUS GROUND PLANE.

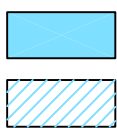

SOLID BLUE DENOTES PCB COPPER LAYOUT WITH SMOBC (SOLDER MASK OVER BARE COPPER)
 HATCHED BLUE DENOTES COPPER LAND PATTERN FREE OF SOLDER MASK

UNLESS OTHERWISE SPECIFIED

DIMENSIONS ARE IN INCHES
 TOLERANCES ON:
 2 PL DECIMALS ±
 3 PL DECIMALS ± .005
 ANGLES ±
 FRACTIONS ±

	INITIALS	DATE
DRAWN	MMG	11/05/02
CHECKED	AV	11/14/02
APPROVED	HY	11/15/02



Mini-Circuits®

13 Neptune Avenue
 Brooklyn NY 11235

PL, kx, BJ293, JYPQ, TB-216

Mini-Circuits®
 THIS DOCUMENT AND ITS CONTENTS ARE THE PROPERTY OF MINI-CIRCUITS. EXCEPT FOR USE EXPRESSLY GRANTED, IN WRITING, TO ITS VENDORS, VENDEE AND THE UNITED STATES GOVERNMENT, MINI-CIRCUITS RESERVES ALL PROPRIETARY DESIGN, USE, MANUFACTURING AND REPRODUCTION RIGHTS THERETO. THESE CONTENTS SHALL NOT BE USED, DUPLICATED OR DISCLOSED TO ANY OUTSIDE PARTY, IN WHOLE OR IN PART, WITHOUT WRITTEN PERMISSION OF MINI-CIRCUITS.

ASHEETA1.DWG REV:A DATE:01/12/95

SIZE	CODE IDENT	DRAWING NO:	REV:
A	15542	98-PL-100	A
FILE:	98PL100	SCALE: 6:1	SHEET: 1 OF 1

Evaluation Board and Circuit

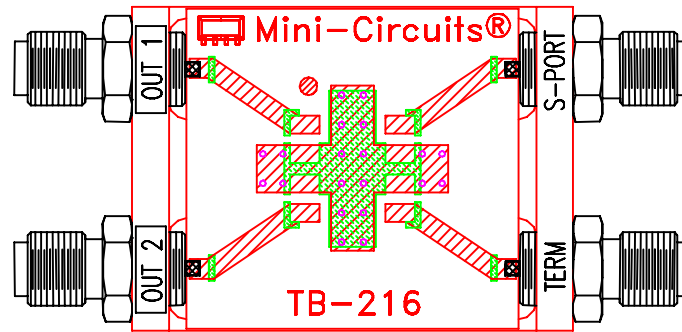

TB-216

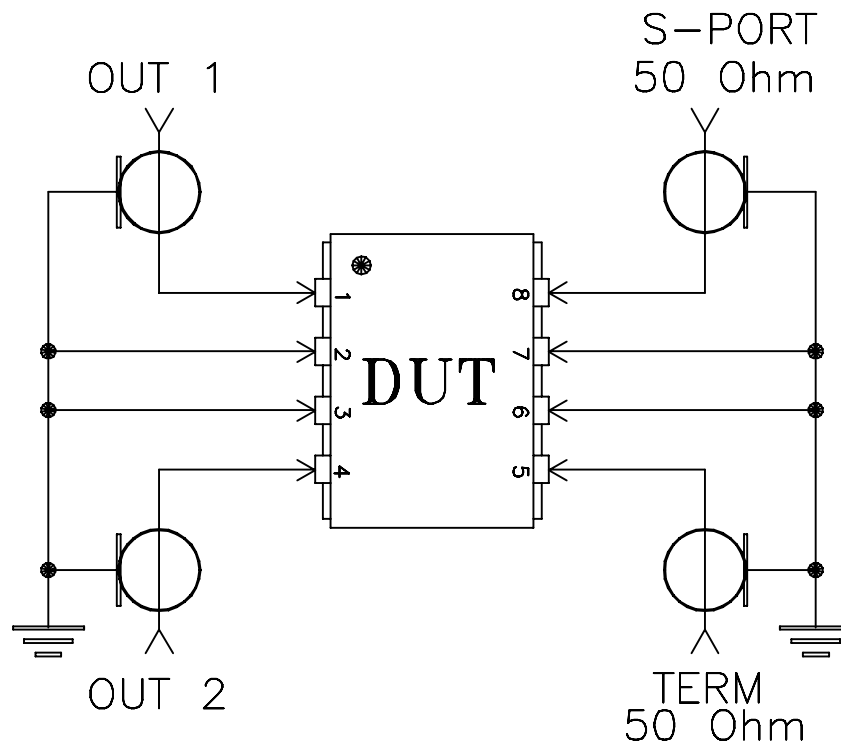

Schematic Diagram

Notes:

1. SMA Female connectors.
2. PCB Material: Rogers R04350 or equivalent,
Dielectric Constant=3.5, Thickness=.030 inch.

 **Mini-Circuits®**

All Mini-Circuits products are manufactured under exacting quality assurance and control standards, and are capable of meeting published specifications after being subjected to any or all of the following physical and environmental test.

Specification	Test/Inspection Condition	Reference/Spec
Operating Temperature	-40° to 85°C Ambient Environment	Individual Model Data Sheet
Storage Temperature	-55° to 100° C Ambient Environment	Individual Model Data Sheet
Humidity	90 to 95% RH, 240 hours, 50°C	MIL-STD-202, Method 103, Condition A, Except 50°C and end-point electrical test done within 12 hours
Thermal Shock	-55° to 100°C, 100 cycles	MIL-STD-202, Method 107, Condition A-3, except +100°C
Solder Reflow Heat	Sn-Pb Eutetic Process: 225°C peak Pb-Free Process 245° - 250°C peak	J-STD-020, Table 4-1, 4-2 and 5-2, Figure 5-1
Solderability	10X Magnification	J-STD-002, 95% Coverage
Vibration (High Frequency)	20g peak, 10-2000 Hz, 12 times in each of three perpendicular directions (total 36)	MIL-STD-202, Method 204, Condition D
Mechanical Shock	50g, 11 ms, 1/2-sine, 18 shocks: 3 each direction, each of 3 axes	MIL-STD-202, Method 213, Condition A
Marking Resistance to Solvents	Isopropyl alcohol + mineral spirits at 25°C; terpene defluxer at 25°C; distilled water + proylene glycol monomethyl ether + monoethanolamine at 63°C to 70°C	MIL-STD-202, Method 215